

Operating instructions

BERGMANN

...the specialists



Loader wagon

ROYAL 260 S
ROYAL 280 K

ROYAL 280 S
ROYAL 300 K

Series: 2-140 - ...
Type: SL12
Document type: Translation of the original operating instructions
Version: 201903 en
Document number: BTA_SL12_ROYAL_201903_en

en

1 General

1.1 Identification

ROYAL 260 S
 ROYAL 280 K
 ROYAL 280 S
 ROYAL 300 K

Type: _____

Vehicle ID No. (VIN): _____

Date of delivery: _____

1.2 Manufacturer

Ludwig Bergmann GmbH	 +49 (0)4444 - 2008-0
	 +49 (0)4444 - 2008-88
	 -
Hauptstraße 64-66 49424 Goldenstedt	 info@l-bergmann.de
	 www.Bergmann-Goldenstedt.de

1.3 Spare parts store

Spare Parts Stock	 +49 (0)4444 - 2008-16
	 +49 (0)4444 - 2008-25
	 -
Hauptstraße 64-66 49424 Goldenstedt	 ersatzteil@l-bergmann.de
	 www.Bergmann-Goldenstedt.de

1.4 Customer service line

Jörg Kammacher	 +49 (0)4444 - 2008-15
	 +49 (0)4444 - 2008-43
	 -
Hauptstraße 64-66 49424 Goldenstedt	 kundendienst@l-bergmann.de
	 www.Bergmann-Goldenstedt.de

1.5 Preface

Dear customer,

You have made a good choice. We would like to thank you for placing your trust in us by purchasing a BERGMANN vehicle.

Ludwig BERGMANN GmbH, 49424 Goldenstedt (Lower Saxony) – a medium sized family-run business in its third generation – has been successfully manufacturing agricultural machinery and transport equipment for over one hundred years. It is one of the major manufacturers and providers of adapted technology for professional farming operations and farm contractors.

The combination of long-standing experience and contemporary, innovative technology is one of our greatest strengths. Constant focus on the needs and desires of customers, adapting to changing technical requirements, the continual development and improvement of our products and not to forget the “feel” for the customer, have made BERGMANN a reliable worldwide farming partner.

With our wide range of products, consisting of manure spreaders, universal spreaders, forage transport trailers, silage trailers, grain transfer trailers and special bodies, we offer economical solutions that prove themselves in the field day after day.

Please check the vehicle for possible shipping damage upon receipt. Check the vehicle against the delivery note to ensure that no parts or optional features are missing. In order to reimburse you for damages, we need your complaint immediately. To do this, follow the “Product transfer instructions” in chapter “Notes for the operating company”.

Read these operating instructions and all other supplied operating instructions carefully before using the vehicle for the first time. Follow the instructions for proper operation, care and maintenance in order to ensure that your vehicle is always ready for use and has a long service life. Always observe the safety instructions listed in these operating instructions. All vehicle operators must have read these operating instructions prior to operation and must be familiar with the vehicle functions.

We wish you every success with your BERGMANN vehicle.

Ludwig Bergmann GmbH – Maschinenfabrik
Goldenstedt

1.6 Copyright

© Copyright by Ludwig Bergmann GmbH, 2021

All rights reserved

Reprinting (including extracts) is only permitted with the permission from Ludwig Bergmann GmbH.

1.7 Table of Contents

1	General	2
1.1	Identification	2
1.2	Manufacturer	2
1.3	Spare parts store	2
1.4	Customer service line	2
1.5	Preface	3
1.6	Copyright	3
1.7	Table of Contents	4
1.8	Important information about the operating instructions	11
1.8.1	Requirements for the operating instructions	11
1.8.2	Purpose and layout of the operating instructions	11
1.8.3	Safekeeping of the operating instructions	11
1.8.4	Reordering operating instructions	12
1.8.5	Scope of the operating instructions	12
1.8.6	Target audience for these operating instructions	12
1.8.7	Assessing the document	12
1.9	Using These Operating Instructions	13
1.9.1	Indexes and References	13
1.9.2	Depiction of Action Instructions and Listings	13
1.9.3	Depiction of Action-Related Warning Symbols	14
1.9.3.1	Design of warning symbols	14
1.9.3.2	Signal words and colouring	14
1.9.4	Depiction of Important Notices	14
1.9.5	Definition of Terms	15
1.9.6	Directional References	15
2	Notes for the operating company	16
2.1	Product Liability, Obligation to Inform	16
2.1.1	Excerpt from the Product Liability Law	16
2.1.2	Information on the Collection of Customer Data	17
2.1.3	Product Transfer Instructions	17
2.1.4	Transfer Declaration	18
3	Vehicle description	19
3.1	Designation	20
3.1.1	Vehicle Identification Number (VIN)	20
3.1.2	CE Symbol	20
3.1.3	Identification Plate - Vehicle	21
3.1.3.1	Position of identification plate	21
3.1.4	Identification Plate - Drawbar	22
3.2	Technical data	23
3.2.1	ROYAL 260 S / 280 K / 280 S / 300 K	24
3.2.1.1	Dimensions	24
3.2.1.2	Weights	25
3.2.1.3	Pick-up	25
3.2.1.4	Cutting unit	25
3.2.1.5	Chassis	25
3.2.1.6	Supply	25
3.2.1.7	Sound emission in air	25
3.2.1.8	Ambient temperature	26
3.3	Tyre acceptance and tyre pressure	26
4	Safety	27
4.1	Proper use	27
4.2	Warning Symbols and Notice Stickers	28
4.2.1	Definition of the Warning Symbols and Notice Stickers	28

4.2.1.1	General.....	28
4.2.1.2	Drive	32
4.2.1.3	Scraper floor.....	32
4.2.1.4	Hydraulic	33
4.2.1.5	Tailgate.....	33
4.2.1.6	Chassis- Tandem axle unit.....	33
4.2.1.7	Silage Trailer	34
4.3	General safety and accident prevention regulations	35
4.3.1	Basic rules	35
4.3.2	Driving.....	35
4.3.3	Road traffic regulations.....	36
4.3.4	Coupling, loading and transport	36
4.3.5	PTO operation	37
4.3.6	Hydraulic system	38
4.3.7	Brakes and tyres.....	39
4.3.8	Maintenance	39
4.4	Important information for vehicle operation	40
4.5	Other hazards.....	41
4.6	Safety instructions.....	41
5	Functions and settings.....	42
5.1	Vehicle functions	43
5.1.1	Loading functions	43
5.1.2	Unloading functions	45
5.2	Drawbar	46
5.2.1	Changing the drawbar	46
5.2.2	Drawbar Adjustment (Hydraulic)	47
5.2.2.1	Vehicle controls	48
5.3	Parking device	49
5.3.1	Mechanical jack stand	49
5.3.1.1	Moving the jack stand into driving position / support position	50
5.4	Pick-up.....	51
5.4.1	Setting the pick-up working height	51
5.4.2	Locking / Unlocking the Pick-up	52
5.4.3	Raising / Lowering the Pick-up	53
5.4.4	Starting / stopping pick-up	54
5.4.5	Guide Wheels	55
5.4.6	Guide roller	56
5.4.7	Guide Comb and Swath Roller	57
5.4.7.1	Adjusting the height.....	57
5.4.7.2	Setting the angle of inclination	57
5.5	Conveyor unit.....	58
5.5.1	Starting and stopping the conveyor unit	58
5.6	Cutting unit	60
5.6.1	Cutting unit sensor.....	60
5.6.2	Raising / lowering the cutting unit.....	61
5.7	Chassis.....	63
5.7.1	Follow-up steering	63
5.7.1.1	Locking / unlocking the follow-up steering	64
5.8	Cargo Space.....	65
5.8.1	Cargo space access	65
5.8.2	Ladder and Access Door	66
5.8.3	Front wall sensor	67
5.8.4	Extension Walls	67
5.9	Scraper floor	68
5.9.1	Scraper floor chains.....	68
5.9.2	Tensioning systems.....	69
5.9.3	Starting and stopping the scraper floor	70
5.9.3.1	e-control with BCT / CCI / ISOBUS terminal	70
5.10	Dosing unit.....	72

5.10.1	Dosing unit sensor	72
5.10.2	Starting and stopping the dosing unit	73
5.11	Tailgate	74
5.11.1	Locking / unlocking the tailgate	74
5.11.2	Tailgate positions.....	76
5.11.3	Raising / lowering the tailgate	77
5.11.4	Tailgate sensor	78
5.11.5	Tailgate as cargo space access	79
5.12	Cross conveyor belt	80
5.12.1	Cross conveyor belt positions	80
5.12.1.1	Bringing the cross conveyor belt in the working position.....	81
5.12.1.2	Bringing the cross conveyor belt in the parking position	83
5.12.2	Starting and stopping the cross conveyor belt	85
5.13	Lubrication	87
5.13.1	Lubrication system for roller chains (conveyor unit / pick-up)	87
5.13.1.1	Lubrication pump	88
5.13.1.2	Lubrication points.....	88
5.13.2	Central lubrication system	89
5.13.2.1	Lubrication pump	89
5.14	Drive	91
5.14.1	Drive shaft.....	92
5.14.1.1	Adapting the drive shaft	92
5.14.1.2	Drive shaft coupling and connection	93
5.14.1.3	Installing the drive shaft	95
5.14.1.4	Removing the drive shaft	96
5.14.1.5	Drive shafts with overload clutch or overrunning clutch	98
5.15	Hydraulics	100
5.15.1	Storing the Supply Lines.....	100
5.15.2	Hydraulic Supply Line Markings	101
5.15.3	Hydraulic System "E-Control"	102
5.15.3.1	Control block	102
5.15.3.1.1	Control block emergency operation	102
5.15.3.2	Hydraulic System Supply Line "E-Control"	104
5.15.3.3	Supply System with "E-control"	104
5.15.3.4	Coupling the hydraulic supply lines with "E-control"	108
5.15.3.5	Uncoupling the hydraulic supply lines with "E-control"	109
5.16	Terminal.....	109
5.17	Brake system	110
5.17.1	Parking brake with hand crank	111
5.17.1.1	Hand crank in rest position and in operating position	112
5.17.1.2	Releasing parking brake with hand crank.....	112
5.17.1.3	Engaging parking brake with hand crank	112
5.18	Electrical system	113
5.18.1	Operation	113
5.18.2	Setting sensors.....	114
5.18.2.1	Inductive sensor "Opener" & "Closer"	114
5.18.3	Lower cutting unit sensor (left)	115
5.18.4	Upper cutting unit sensor (left)	116
5.18.5	Upper front wall sensor (left)	117
5.18.6	Dosing Unit Sensor Right	118
5.18.7	Tailgate Sensor, Bottom (Left & Right).....	119
6	Operation	120
6.1	Terminal BCT20	121
6.1.1	BCT20 Terminal User Surface	122
6.1.2	Quick Start with BCT20 Terminal	123
6.1.3	BCT20 Terminal Menu Structure.....	124
6.1.3.1	Menu 1/4: Driving on roads	124
6.1.3.2	Menu 2/4: Unloading	125
6.1.3.3	Menu 3/4: Trip counter	127
6.1.3.4	Menu 4/4: Loading	128

6.2	ISOBUS terminal CCI50 / CCI200	130
6.2.1	CCI50 / CCI200 Terminal Operating Panel	131
6.2.2	CCI50 / CCI200 / ISOBUS Terminal Menu Design	133
6.2.2.1	Menu 1/4: Driving on roads	134
6.2.2.2	Menu 2/4: Unloading	136
6.2.2.2.1	Function sequences A and B	140
6.2.2.2.2	Settings	142
6.2.2.2.3	Scraper floor mode	144
6.2.2.3	Menu 3/4: Trip counter	145
6.2.2.4	Menu 4/4: Loading	149
6.2.2.4.1	Function sequences A and B	153
6.2.2.4.2	Settings	155
6.2.2.4.3	Scraper floor mode	156
6.2.2.5	Menu: Service Access	156
6.3	Terminal Pilotbox cross conveyor belt	157
6.3.1	User interface of the Pilotbox cross conveyor belt terminal	158
7	Commissioning	160
7.1	Securing the vehicle against unintentional rolling and starting	161
7.2	After delivery	162
7.3	Adapting to the tractor	163
7.3.1	Changing the drawbar	163
7.3.1.1	Coupling unit with flange	163
7.3.1.2	Drawbar with shaft	164
7.3.2	Setting the Pick-up Working Height	165
7.3.3	Adapting the drive shaft	167
7.3.3.1	Shortening the drive shaft	168
7.3.3.2	Shortening the drive shaft guard	169
7.4	Coupling to the tractor	170
7.4.1	Preparations	170
7.4.2	Connecting the hydraulics	171
7.4.3	Connecting the terminal (with E-control)	171
7.4.4	Coupling the vehicle	171
7.5	Uncoupling from the tractor	172
7.5.1	Uncoupling the vehicle	173
8	Use	174
8.1	Before use	175
8.1.1	General	175
8.1.2	Setting the follow-up steering	175
8.1.3	Setting the brake system	175
8.1.4	Setting the pick-up working height	176
8.1.5	Setting the guide comb and swath roller	176
8.2	Loading	177
8.2.1	Determining payload and permissible load volume	178
8.2.2	Loading with a Pick-Up Version: Vehicles without auto-load	179
8.2.2.1	Preparing the loading procedure	179
8.2.2.2	Loading procedure	180
8.2.2.3	Completing the loading procedure	180
8.2.3	Loading with a Pick-Up Version: Vehicles with auto-load	181
8.2.3.1	Preparing the loading procedure	181
8.2.3.2	Loading procedure	182
8.2.3.3	Completing the loading procedure	182
8.2.4	Clearing conveyor unit blockages	183
8.3	Unloading	184
8.3.1	Unloading without dosing unit (type "K")	184
8.3.1.1	Preparing the unloading procedure	184
8.3.1.2	Unloading procedure	184
8.3.1.3	Completing the unloading procedure	185
8.3.2	Unloading with dosing unit (type "S")	186
8.3.2.1	Preparing the unloading procedure	186

8.3.2.2	Unloading procedure	187
8.3.2.3	Completing the unloading procedure	187
8.3.3	Unloading with dosing unit (type "S") and cross conveyor belt	188
8.3.3.1	Preparing the unloading procedure	188
8.3.3.2	Unloading procedure	189
8.3.3.3	Completing the unloading procedure	189
8.3.4	Removing blockages in the dosing unit	190
8.4	Driving on roads	191
8.4.1	Moving vehicle parts to driving position	191
8.4.2	Locking the steering axle	191
8.4.3	Driving style	192
9	Care and maintenance	193
9.1	Cleaning and maintenance work in the cargo space	194
9.1.1	Cargo space access	194
9.2	Maintenance schedule	195
9.3	Screw tightening torques	197
9.4	Cleaning the vehicle	198
9.4.1	Cleaning the vehicle with a high-pressure cleaner	198
9.5	Conveyor unit	199
9.5.1	Rotor	199
9.5.2	Scraper	200
9.6	Cutting unit	201
9.6.1	Cutting unit sensor	201
9.6.2	Cleaning the cutting unit	202
9.6.3	Checking the cutting unit	203
9.6.4	Removing and fitting knives	205
9.6.4.1	Removing knives	205
9.6.4.2	Fitting knives	205
9.6.5	Sharpening knives	206
9.6.6	Adjusting the cutting unit	207
9.6.6.1	Checking the distance	207
9.6.6.2	Setting the distance	208
9.7	Chassis	209
9.7.1	Suspension	209
9.7.2	Tyres and wheels	209
9.7.2.1	Wheel nuts and wheel bolts	210
9.7.2.2	Tyre pressure	210
9.7.3	Axles (General)	211
9.7.3.1	Maintenance	211
9.7.3.2	Setting wheel hub bearing play	211
9.7.3.3	Changing the wheel hub bearing grease	212
9.7.4	Follow-up steering axles	213
9.7.4.1	Maintenance	213
9.8	Scraper floor	214
9.8.1	Scraper floor chains	215
9.8.1.1	Retensioning scraper floor chains	215
9.8.1.2	Shortening scraper floor chains	215
9.8.1.3	Shortening scraper floor chains with different strand lengths	216
9.9	Cross conveyor belt	217
9.9.1	Cleaning the cross conveyor belt	217
9.9.2	Adjusting and tensioning the cross conveyor belt	218
9.9.3	Setting the cross conveyor belt angle	220
9.10	Lubrication	221
9.10.1	Lubrication schedule	223
9.10.1.1	Lubrication schedule ROYAL - Model "K"	224
9.10.1.2	Lubrication schedule ROYAL - Model "S"	225
9.10.1.3	Lubrication schedule, axle	226
9.10.1.4	Lubrication schedule, axle	226
9.10.1.5	Lubrication schedule cross conveyor belt	227
9.10.2	Lubrication system	228

9.10.2.1	Cleaning the lubrication system	228
9.10.2.2	Maintenance of the lubrication system	228
9.10.2.3	Filling lubricant on roller chain lubrication system	229
9.10.2.4	Filling lubricant on central lubrication systems	231
9.11	Drive	232
9.11.1	Drive shaft.....	232
9.11.1.1	Maintenance of the Walterscheid drive shaft.....	232
9.11.1.2	Maintenance of Walterscheid overload clutch and overrunning clutch	235
9.11.2	Gearbox.....	237
9.11.2.1	Gearbox oil.....	237
9.11.2.2	Gearbox allocation and filling quantities	238
9.11.3	Roller chains	240
9.11.3.1	Conveyor unit drive.....	240
9.11.3.2	Pick-up drive	242
9.11.3.3	Dosing unit - drive (depending on the vehicle's equipment).....	243
9.11.4	Clutches on vehicle type "S"	244
9.11.4.1	Conveyor unit coupling	244
9.11.4.2	Dosing unit clutch.....	244
9.12	Hydraulic system	246
9.12.1	Hydraulic system – circulating hydraulics.....	246
9.12.1.1	Hydraulic oil filter.....	246
9.13	Brake system	247
9.13.1	Parking brake	247
9.13.2	Air brake system.....	248
9.13.2.1	Trailer brake effect regulator (manual adjustment) (if fitted).....	248
9.13.2.2	ALB – automatic load sensing brake effect regulator (if fitted).....	248
9.13.2.3	Draining the air tank.....	248
9.13.2.4	Cleaning the line filter	249
9.13.2.5	Leaktightness test.....	249
9.13.2.6	Checking reservoir pressure.....	249
9.13.2.7	Checking brake cylinder pressure	249
9.13.2.8	Checking brake cylinder stroke.....	250
9.13.2.9	Adjusting the brake levers	250
9.13.2.10	Adjusting the linkage control element.....	250
9.14	Connection diagrams	251
9.14.1	Connection diagrams – hydraulics	252
9.14.1.1	Version: e-control (part 1)	252
9.14.1.2	Version: e-control (part 2)	253
9.14.2	Connection diagrams – brake system	254
9.14.2.1	Version: Air brake - mechanical axle balance	254
9.14.3	Connection diagrams – electrical system.....	256
9.14.3.1	BCT 20 terminal.....	256
9.14.3.2	CCI 50 & CCI 200 terminal (standard 1).....	257
9.14.3.3	CCI 50 & CCI 200 terminal (standard 2).....	258
9.14.3.4	CCI 50 & CCI 200 terminal (optional)	259
9.14.3.5	ISOBUS terminal (standard 1)	260
9.14.3.6	ISOBUS terminal (standard 2)	261
9.14.3.7	Terminal Pilotbox cross conveyor belt (silage trailer)	262
9.14.3.8	Wiring harness BCT / CCI / ISOBUS.....	263
9.14.3.8.1	Wiring harness legend.....	264
10	Faults and remedies	266
10.1	Loader wagon (general)	267
10.2	Central lubrication system.....	268
11	Declaration of Conformity	269
11.1.1	ROYAL 260 S / 280 S / 280 K / 300 K.....	269
12	Contact Details & Contact Persons.....	270
12.1	Manufacturer	270
12.2	Authorized officer / Sale.....	270
12.3	General Manager Export.....	270

12.4	Sales management Export West.....	270
12.5	Sales management Export East.....	271
12.6	Spare Parts Stock	271
12.7	Customer service management.....	271
12.8	Emergency service	271
12.9	Worldwide Sales Partners	271

1.8 Important information about the operating instructions

Operate the vehicle only after a briefing and under observation of these operating instructions. Always observe the safety instructions when working with or on the vehicle.

1.8.1 Requirements for the operating instructions

The operating instructions conform to the requirements of the following standards and regulations:

- ISO 3600:2015-07 Tractors, machinery for agriculture and forestry, powered lawn and garden equipment – Operator's manuals – Content and format

1.8.2 Purpose and layout of the operating instructions

These operating instructions are part of the vehicle. In addition to a detailed technical description, they provide both general and specific information about the following topics:

- Safety
- Commissioning
- Function and operation
- Using the vehicle
- Care and maintenance
- Storage and disposal
- Rectifying operating faults

Operate the vehicle only after a briefing and under observation of these operating instructions. Always observe the safety instructions when working with or on the vehicle.

Should anything still be unclear, please contact your BERGMANN dealership or BERGMANN customer service.



BERGMANN contact information can be found in chapter "Contact details & contact persons".

1.8.3 Safekeeping of the operating instructions

Always keep these operating instructions with the vehicle or in the tractor, ready for use. If the customer transfers the vehicle to a third party, the operating instructions must also be passed on to the new owner.

1.8.4 Reordering operating instructions

Should these operating instructions have become wholly or partly unusable, you can request a replacement document from BERGMANN. To do this, specify the following data of your vehicle:

- Type
- Model
- Vehicle ID No. (VIN) / series:

You can find this data on the front page of your operating instructions or directly on the identification plate of your vehicle.



BERGMANN contact information can be found in chapter "Contact details & contact persons".

1.8.5 Scope of the operating instructions

The components and vehicle functions listed in the operating instructions may differ from the vehicle standard equipment and are available as optional features in some cases. Since these operating instructions are general, various equipment options can be listed that are not available for your vehicle. This also applies to illustrations. Images, drawings and 3D illustrations in these operating instructions do not always represent the exact vehicle type. However, the information which refers to the illustrations always corresponds to the vehicle type in this document.

Depending on your vehicle's equipment, you may have received further documents for special vehicle components (e.g. operating instructions "Machine control") and third-party documents from other manufacturers (e.g. the operating instructions for drive shafts). The safety instructions, operating instructions and further information given in these documents must also be observed and have priority in case of doubt or discrepancies. If you do not have these documents, you can find them on the CD at the end of these operating instructions.

1.8.6 Target audience for these operating instructions

These operating instructions are intended for all people operating the vehicle, who must fulfil the minimum personnel qualifications.



When doing this, observe the information and instructions in chapter "Safety", section "Obligations and qualification of operators".

1.8.7 Assessing the document

Because our products are being continually developed to meet the latest technical standards, our operating instructions are also regularly updated. We therefore must reserve the right to make changes. All information, illustrations and technical details in these operating instructions correspond to the latest state at the time of publication.

We would welcome your help as readers and users of the vehicle to make these operating instructions even more user-friendly. Please send us your suggestions for improvements by fax or e-mail.



BERGMANN contact information can be found in chapter "Contact details & contact persons".

1.9 Using These Operating Instructions

1.9.1 Indexes and References

Table of contents / Headings

The table of contents and the headings in these operating instructions provide for quick orientation in the chapters.

Table of Figures:

The table of figures in these operating instructions makes it possible to scroll directly to the desired images using the respective name

Index of Technical Terms:

In the index of technical terms it is possible to find specific topics in the operating instructions using keywords which are listed in alphabetical order. The index of technical terms can be found at the end of these operating instructions.

Cross References:

For further information on a topic in these operating instructions or another document, a cross-reference to the relevant section can be found at the end of the section. Chapters, subchapters and sections are enclosed in quotation marks.

Example:



BERGMANN contact information can be found in the chapter "Contact Info & Contact Persons".

The page number of the respective chapter, subchapter or section can be found in the table of contents or in the index of technical terms.

1.9.2 Depiction of Action Instructions and Listings

Action Step:

A dot (•) in front of the sentence defines an action step which must be carried out.

Example:

- Carry out action.

Action Sequences:

Multiple dots (•) in front of the sentence define an action sequence which must be carried out.

Example:

- Carry out action 1.
- Carry out action 2.
- Carry out action 3.

Listings:

Multiple dashes (-) before each sentence define listings.

Example:

- Listings 1
- Listings 2
- Listings 3.

1.9.3 Depiction of Action-Related Warning Symbols

1.9.3.1 Design of warning symbols

	SIGNAL WORDS!
	<p>Type and source of danger Possible result(s) of the danger</p> <ul style="list-style-type: none"> • Measures to avoid the danger

1.9.3.2 Signal words and colouring

	DANGER!
	<p>The signal word "Danger" identifies a hazard with a high degree of risk. Failure to avoid the hazard will result in death or serious injury.</p>

	WARNING!
	<p>This signal word identifies a hazard with a moderate degree of risk. Failure to avoid the hazard can result in death or serious injury.</p>

	CAUTION!
	<p>This signal word identifies a hazard with a low degree of risk. Failure to avoid the hazard can result in minor or moderate injury.</p>

1.9.4 Depiction of Important Notices

	NOTICE
	<p>Indicates a requirement for particular behaviour or an action, as well as tips for use and particularly useful information for proper use of the machine. This information will help you to make optimum use of all machine functions. Failure to observe these notices can lead to machine malfunctions or damage to the environment.</p>

1.9.5 Definition of Terms

Term	Explanation
Machine	LOADER WAGON is referred to using the term machine in this document.
Danger	Danger is a condition or situation in which the possibility of a health risk exists. The danger arises from a possible injury or disease-causing spatial and/or temporal coincidence from a source of danger.
Manufacturer	Ludwig Bergmann GmbH
Adjustment elements	Adjustment elements are parts of the controller that detect operator input signals, usually made by hand or foot. There are many different adjustment elements, such as buttons, levers, switches, knobs, slide controllers, joysticks, handwheels, pedals, keyboards, and tactile screens. Adjustment elements may be located on the machine itself or, as with remote controls, at a certain distance from the machine and connected to the machine for example by cable or by radio, optical or acoustic signals.
Third persons	Third persons are all other persons other than the operator themselves.

1.9.6 Directional References

Directional references such as

- front
- rear
- left
- right
- etc.

Are always indicated in the direction of travel. (see Image 1).

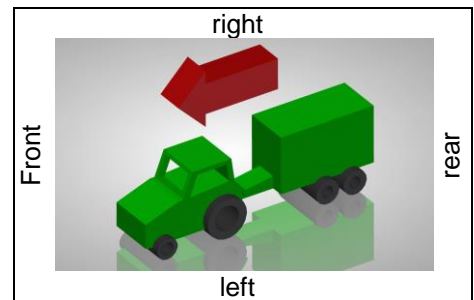



Image 1: Directional references

2 Notes for the operating company

Chapter "Notes for the operating company" provides information and instructions on the following topics:

- Product liability & information obligation
- Product handover instructions
- Warranty & liability

	NOTE
	Always carry out the points in chapter "Notes for the operating company" as soon as you have received the vehicle. Otherwise you cannot make any warranty claims against BERGMANN.

2.1 Product Liability, Obligation to Inform

Product liability requires the manufacturer and dealer to go through the operating instructions and to instruct the customer at the time of transfer, paying particular attention to operational, safety and maintenance requirements.

In order to prove that the machine and the operating instructions were transferred properly, written confirmation is needed. Below you will find the forms "Product transfer instructions" and "Transfer declaration". If you did not receive these forms, copies of the forms can be found in the operating instructions for use as templates. After the transfer has been made, the forms must be completed, signed and returned to BERGMANN.

Ludwig Bergmann GmbH	 +49 (0)4444 - 2008-0
	 +49 (0)4444 - 2008-88
	 -
	 info@l-bergmann.de
Hauptstraße 64-66 49424 Goldenstedt	 www.Bergmann-Goldenstedt.de

	NOTICE
	If the vehicle is transferred by the customer to a third party, the operating instructions must also be given to the new owner and the new owner must be made aware of the requirements.

	NOTICE
	Please note that the right to make claims under guarantee only exists after this transfer statement has been filled out, signed and returned to Bergmann.

2.1.1 Excerpt from the Product Liability Law

- According to the German product liability law, every farmer is the owner of a business.
- According to the German product liability law, property damage is damage which is caused by a vehicle, but not damage caused to a vehicle. The liability includes a 500 Euro excess.
- In accordance with the German product liability law, damages to the business are not covered.

2.1.2 Information on the Collection of Customer Data

The required customer information, which is recorded on BERGMANN forms and passed on to Ludwig Bergmann GmbH, is stored, processed and used for product monitoring by BERGMANN.

2.1.3 Product Transfer Instructions

According to product liability requirements, the following listed points must be checked:

Completed: Please mark applicable boxes.

<input type="checkbox"/>	Vehicle was checked against the delivery note. All safety equipment, PTO shafts and control elements are present.
<input type="checkbox"/>	The operation, commissioning, instruction and maintenance of the machine were discussed with and explained to the customer based on the operating Instructions.
<input type="checkbox"/>	Tires checked for proper air pressure.
<input type="checkbox"/>	Wheel nuts checked for tightness.
<input type="checkbox"/>	Instructed on proper PTO shaft rpm.
<input type="checkbox"/>	Mechanical functions demonstrated and explained.
<input type="checkbox"/>	Electrical connection to the tractor was made and checked for proper connection. Observe notices in the operating instructions!
<input type="checkbox"/>	Adapted to tractor.
<input type="checkbox"/>	PTO shaft shortened to proper length.
<input type="checkbox"/>	Electrical system functions were checked and explained.
<input type="checkbox"/>	Hydraulic connection to the tractor was made and checked for proper connection.
<input type="checkbox"/>	Hydraulic functions were demonstrated and explained.
<input type="checkbox"/>	Parking and service brake function tested.
<input type="checkbox"/>	Test run was made and no deficiencies were found.
<input type="checkbox"/>	Explanation of functions during test run.
<input type="checkbox"/>	Information about optional and extra equipment was provided.
<input type="checkbox"/>	Informed that reading the operating instructions is absolutely necessary

The above mentioned points were carried out correctly and documented in the form "Product transfer instructions".

_____ Signature of owner / authorized representative	_____ Date
_____ Signature of Customer service	_____ Date

2.1.4 Transfer Declaration

1.	<u>Machine</u>	
	Model designation	Vehicle identification number (VIN):
2.	<u>Customer / Owner</u>	
	Name, First name	Owner no.
	Street, house no.	
	Country	Post code
	City/town	
	E-mail address (business)	
Telephone (business)		Mobile (business)
3.	<u>Record of transfer</u>	
	I received the following documents during product transfer. <input type="checkbox"/> The operating instructions <input type="checkbox"/> The EU Declaration of Conformity	Day of transfer
	The machine mentioned in 1), supplied by BERGMANN under retention of title, was purchased by me with recognition of the warranty provisions and transferred completely in brand-new, operational condition. The operating, safety, commissioning and maintenance instructions for the machine were discussed with and explained to me based on the operating instructions. The "Product Transfer Instructions" form has been completed in accordance with product liability requirements. I hereby undertake to strictly observe all instructions and information, to avoid the aforementioned sources of danger and, in the same way, I am obligated and inform all persons who work on the machine. I acknowledge that in the event of non-compliance with the operating and safety requirements, or in the event of damage due to a cause which is stated in the operating instructions, the manufacturer's liability is void.	Date
	Signature of owner / authorized representative	Date
4.	<u>Sales partner / importer (clearing centre)</u>	
	BERGMANN customer no.	
	Name, First name	
	Street, house no.	
	Country	Post code
	City/town	
	Company stamp	
	<u>Sales office</u>	
	Name, First name	
	Street, house no.	
Country	Post code	
City/town		
Company stamp		
The machine mentioned in 1), supplied by BERGMANN under retention of title, was transferred to the customer with recognition of the warranty provisions and transferred completely in brand-new, operational condition. The transfer was carried out correctly and documented in the form "Product transfer instructions".		
Signature of Customer service		Date

3 Vehicle description

Chapter "Vehicle description" contains information about the vehicle and comprehensive technical data about the vehicle.

The components and vehicle functions listed in the operating instructions may differ from the vehicle standard equipment and are available as optional features in some cases. Since these operating instructions are general, various equipment options can be listed that are not available for your vehicle. This also applies to illustrations. Images, drawings and 3D illustrations in these operating instructions do not always represent the exact vehicle type. However, the information which refers to the illustrations always corresponds to the vehicle type in this document.

To make yourself familiar with the vehicle, read this chapter at the vehicle if possible.

3.1 Designation

The designation shall include the following:

- Vehicle identification number (VIN)
- Identification plate
- CE Symbol

	NOTICE
	The entire designation is a legal document and must not be altered made illegible.

3.1.1 Vehicle Identification Number (VIN)

With the vehicle identification number (VIN) it is possible to clearly identify your vehicle. The VIN can be found on the identification plate and is also engraved on the machine frame near the identification plate.



For this, also observe the instructions and notices in the operating instructions in the “Identification plate - Vehicle” section!

Please enter the vehicle identification number along with the date of delivery and the vehicle type on page 2 in the operating instructions immediately after vehicle transfer. Queries and/or guarantee claims cannot be processed without this number.

3.1.2 CE Symbol

The CE symbol, which is applied by the manufacturer, documents to the public that this vehicle conforms to vehicle regulations requirements.

The CE symbol is located on the vehicle identification plate.



Image 2: CE Symbol



For this, also observe the instructions and notices in the operating instructions in the “Identification plate - Vehicle” section!

3.1.3 Identification Plate - Vehicle

The following information can be found on the identification plate (Image 3):

Manufacturer		
VIN No.	=	Vehicle identification number
Gross vehicle weight	kg	= Gross vehicle weight
Dead weight	kg	= Dead weight
Gross axle weight, front	kg	= Gross axle weight, front
Gross axle weight, rear	kg	= Gross axle weight, rear
Maximum speed	km/h	= Maximum speed
Type		
Year manufactured		
Drive rotational speed	min-1	
Max. hydraulic pressure	cash	= Maximum hydraulic pressure



Image 3: Identification plate - vehicle



NOTICE

Weights and other data specified on the identification plate must not be exceeded.

3.1.3.1 Position of identification plate

The identification plate (Image 4 / Pos. 1) is located at the front, on the cross beam of the frame.



Image 4: Position of identification plate

3.1.4 Identification Plate - Drawbar

In case of inspection, a identification plate is located directly on the drawbar. The following information can be found on the identification plate (Image 5):

Manufacturer			
Drawbar type			
Ident. No.		=	Identification number
Gross trailer weight	kg	=	Gross trailer weight
Gross nose weight	kg	=	Gross nose weight
Maximum speed	km/h	=	Maximum speed



Image 5: Identification plate - drawbar



NOTICE

Weights and other data specified on the identification plate must not be exceeded.

3.2 Technical data

All information, illustrations and technical data contained in these operating instructions corresponded to the latest state of technology at the time of publication. Technical data may deviate depending on equipment on the delivered vehicle and is therefore non-binding.

We reserve the right to make changes to the design at any time without prior notice.

	WARNING!
	<p>There is a danger of component failure if the vehicle's technical limit values are not observed.</p> <p>The vehicle's technical limit values must be observed. If they are not observed,</p> <ul style="list-style-type: none">- the vehicle can become damaged,- accidents can result,- people can sustain serious injuries or death. <p>The following limit values are especially important for safety:</p> <ul style="list-style-type: none">- Permissible gross weight- Maximum axle load- Maximum payload- Maximum nose weight- Maximum total height- Top speed <p>The limit values must be maintained. Non-observation of these values invalidates any warranty claims. If the weights are not known, the vehicle must be weighed before being taken on public roads.</p>



These limit values must be complied with. Limit values can be found on the next page.

3.2.1 ROYAL 260 S / 280 K / 280 S / 300 K

3.2.1.1 Dimensions

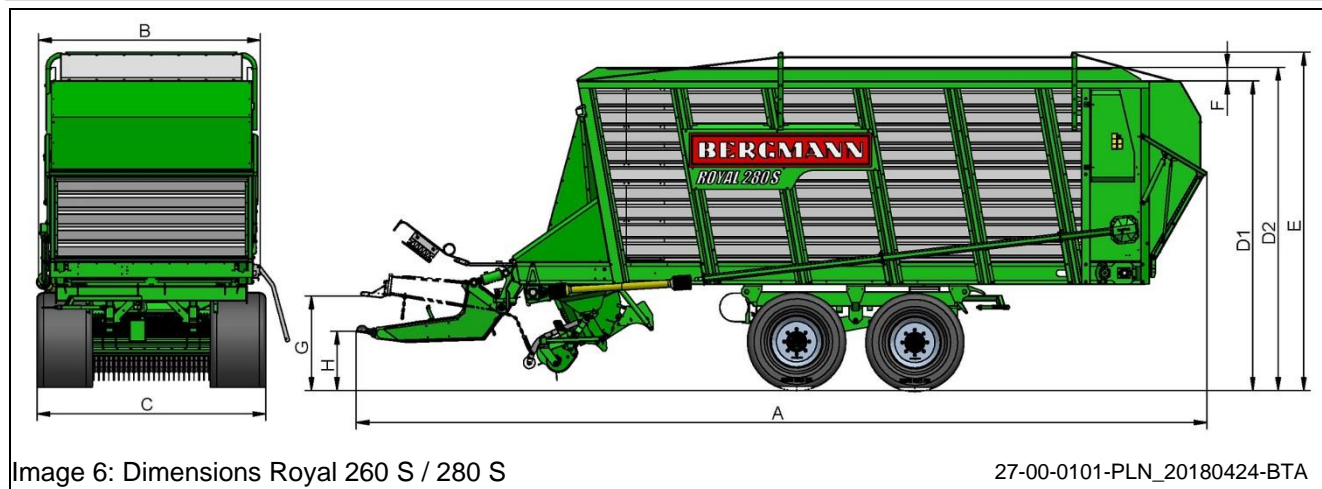

Image 6: Dimensions Royal 260 S / 280 S

27-00-0101-PLN_20180424-BTA

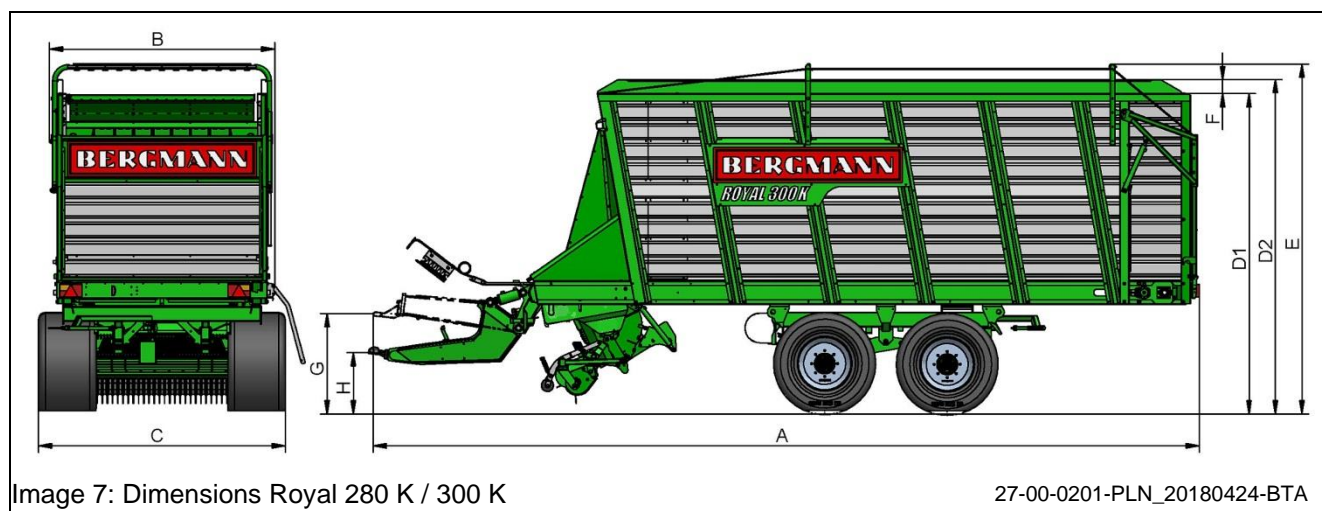

Image 7: Dimensions Royal 280 K / 300 K

27-00-0201-PLN_20180424-BTA

Model			260 S	280 K	280 S	300 K				
Vehicle dimensions										
Length	A	mm	9,330	8,745	9,330	8,745				
Width (frame)	B	mm	2,435	2,435	2,435	2,435				
Width (tyres)	C	mm	2,510	2,510	2,510	2,510				
Height (side wall)	D1	mm	3,390	3,390	-	-				
Height (extension)	D2	mm	-	-	3,540	3,540				
Height (bracket)	E	mm	3,705	3,705	3,855	3,855				
Extension height	F	mm	-	-	150	150				
Height of top coupling	G	mm			1,007	1,007				
Height of bottom coupling	H	mm			584	584				
Load volume according to DIN 11741										
Up to side wall height		m ³	26.8	28.4	-	-				
With extension		m ³	-	-	28.4	30.0				
Reference tyres			620/40 R 22.5							

The data on the vehicle's identification plate and in the vehicle registration documents apply to your vehicle. All data is based on standard tyres. Technical data, weights and dimensions are not binding for delivery. Subject to technical changes.

3.2.1.2 Weights

Model		260 S	280 K	280 S	300 K				
Perm. gross weight									
With top coupling	kg	16,000	16,000	16,000	16,000				
With bottom coupling	kg	17,000	17,000	17,000	17,000				
Perm. axle load	kg								
With top coupling	kg	14,000	14,000	14,000	14,000				
With bottom coupling	kg	14,000	14,000	14,000	14,000				
Perm. nose weight									
With top coupling	kg	2,000	2,000	2,000	2,000				
With bottom coupling	kg	3,000	3,000	3,000	3,000				
Unladen weight	kg	6,650	5,990	6,700	6,040				
Payload									
With top coupling	kg	9,350	10,010	9,300	9,960				
With bottom coupling	kg	10,350	11,010	10,300	10,960				

The data on the vehicle's identification plate and in the vehicle registration documents apply to your vehicle. All data is based on standard tyres. Technical data, weights and dimensions are not binding for delivery. Subject to technical changes.

3.2.1.3 Pick-up

Model		260 S	280 K	280 S	300 K				
Ground clearance, pick-up	mm	~350	~350	~350	~350				
Ground clearance with extended high-lift drawbar	mm	~600	~600	~600	~600				
Intake width	mm	1,940	1,940	1,940	1,940				

3.2.1.4 Cutting unit

Model		260 S	280 K	280 S	300 K				
Number of knives	pce.	41	41	41	41				
Shortest theoretical cut length	mm	34	34	34	34				

All data is based on standard tyres.

3.2.1.5 Chassis

Model		260 S	280 K	280 S	300 K				
Design									
Series		Tandem	Tandem	Tandem	Tandem				
Optional		-	-	-	-				
Tyres min. / max.		See list of acceptable tyres							
Wheel connection	Hole	8	8	8	8				
Track width (offset 0)	mm	1,900	1,900	1,900	1,900				
Perm. top speed	km/h	40	40	40	40				
Brake		Two-circuit air brake system Operating pressure 7.3 bars							

3.2.1.6 Supply

Model		260 S	280 K	280 S	300 K				
Max. hydraulic pressure	bar	210							
Max. oil flow rate	l/min	100							
Hydraulic connections		See chapter "Functions and settings" Section "Hydraulics"							
Required power	kW (hp)	59 (80)							
PTO speed	rpm	1000 (clockwise looking at the free shaft stub)							
Power supply	Volt	12 V DC							
Lighting system		7-pole socket 12 V DC							

3.2.1.7 Sound emission in air

Model		260 S	280 K	280 S	300 K				
Continuous sound pressure level	dB(A)	< 70							

3.2.1.8 Ambient temperature

Model		260 S	280 K	280 S	300 K				
Vehicle operating temperature	°C	-5°C to +45°C							

3.3 Tyre acceptance and tyre pressure

Check the tyre pressure at least every two weeks with cold tyres. Caps must be fitted to the valves.

Ø	Designation	Load index	Width	Height	40 km/h		max. km/h			Data from
					Payload	Tyre pressure	Use	Payload	Tyre pressure	
			mm	mm	kg	bar	km/h	kg /	bar	
22.5"	620/40 R 22.5	148D	610	1,085	4,280	3.2	65	3,150	3.2	Vredestein
22.5"	710/35 R 22.5	157D	712	1,069	5,620	4.0	65	4,125	4.0	Nokian



Observe also the notes and instructions in the operating instructions, chapter "Care and maintenance", section "Tyres".

4 Safety

This chapter contains important information for the owner and the operator to ensure safe and trouble-free operation of the machine.

	NOTICE
	<p>Observe all safety instructions in these operating instructions and in the supplementary documents!</p> <p>Most accidents happen when the simplest safety regulations are not observed. By observing all safety instructions in these operating instructions, you will help to prevent accidents.</p>

4.1 Proper use

The vehicle

- is intended only for the usual use in agricultural work,
- is suitable for loading, cutting, transporting and unloading green fodder (herbage), coarse fodder (roughage), wilted silage and straw,
- must be operated only by one person from the driver's seat of the tractor (one-person operation).

Proper use also includes:

- observation of all notes and instructions in these operating instructions;
- observation of the manufacturer's operating, maintenance and repair instructions;
- exclusive use of original spare parts.

All other uses are not permitted and are therefore not regarded proper use.

In the event of damage resulting from improper use,

- the operating company has sole responsibility;
- the manufacturer does not accept liability.

4.2 Warning Symbols and Notice Stickers

The warning symbols on the vehicle are provided for the safety of all persons who work with the vehicle, and warn about other dangers. The notices identify vehicle specific characteristics which need to be observed in order to provide for flawless vehicle operation.

- All warning symbols / safety notices should be strictly adhered to!
- Pass all safety instructions on to other users.
- Keep the warning symbols and notices on the vehicle in good condition!
- Replace missing warning symbols and notices (Order numbers are located on the warning symbols and notices)!

The following are warning symbols and notice stickers with their meanings.

4.2.1 Definition of the Warning Symbols and Notice Stickers

4.2.1.1 General



B06-0084

Lubrication points

(For lubrication points see "Care and maintenance / lubrication diagram.")



B06-0256

Maximum speed 25km/h



B06-0380

Maximum speed 40km/h



B06-0534

Only stand in dangerous areas when safety devices are engaged!

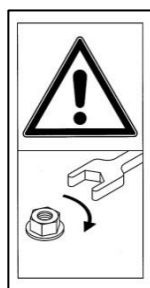

B06-0539

Tighten wheel nuts and other bolted connections after the first operating hours!

 Carefully read operating instructions before operating. Observe instructions and safety notice when operating. (GB)

Cleaning instructions
when using a high-pressure cleaner:

- Not before **8 weeks** after delivery (paint curing)
- Minimum spraying distance **50 cm**
- Maximum pressure **50 bar**
- Maximum temperature **50°C**
- Spraying angle **25°**
- Do **not use** detergents
- **Keep away** from seals for bearings, gears and hydraulic parts



B06-0541-GB

B06-0541
Read and observe operating instructions and safety notices before initial operation!

Cleaning instructions pressure washer use



B06-0542
Be careful of moving parts! Never reach into the running machine! Do not open or remove safety equipment while motor is running!

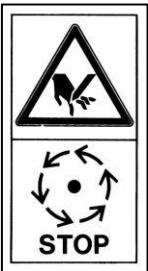

B06-0543
Only touch machine parts when they come to a complete standstill!
Before working on spreader disks, switch off PTO shaft and motor and remove ignition key!



B06-0545
Riding on stepping areas or platforms is not authorized!



B06-0546
Before uncoupling the vehicle, use wheel wedges to secure the vehicle against accidental rolling!



B06-0547
The carrying and transportation of persons is prohibited unless appropriate seats are available.

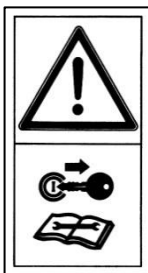

B06-0549
Switch off motor and remove ignition key before maintenance and repair work!

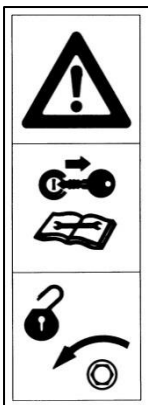

B06-0556
Switch off motor and remove ignition key before maintenance and repair work!



B06-0602
Jack stand must be in the upper most position during operation. The jockey wheel must be rotated upwards and towards the rear of the vehicle.



B06-0607
Only stand in dangerous areas when safety devices are engaged! Never reach into areas where the hands can be crushed as long as parts are moving! Danger, rotating machine parts! Keep sufficient distance from rotating parts!



B06 0608
Do not stand in the movement range of the lift drawbar during operation.



B06-0609
Never reach into areas where hands can be crushed as long as parts are moving!



B06 0626
Keep sufficient distance from hot surfaces.



B06-0869
Prior to every use, make sure that no one is in the immediate area (Especially children!) Ensure sufficient view e.g. when backing up!

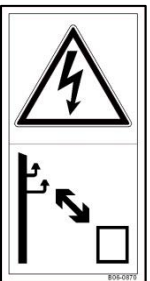

B06-0870
The height can exceed 4000 mm when Machine parts are moved out for work. Be careful of overhead lines and bridge crossings. Safety distance:
Nominal voltage Overhead lines
Up to 1 KV 1 m
over 1 - 110 KV 3 m
over 110 - 220 KV 4 m
over 220 - 380 KV 5 m

(GB)

! Attention!

Retighten wheel nuts:

- ⇒ after 50 km of driving
- ⇒ after further 150 km of driving
- ⇒ after further 400km of driving.

- Within the first operating week the wheel nuts have to be checked on firm fit each day.
- For further operating the wheel nuts have to be checked weekly.

B06-0968-GB

B06-0968
Tighten wheel nuts.
(See "Care and maintenance" section)

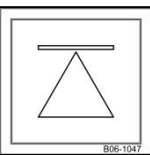

B06-1047
Features attachment points on the axes for lifting devices.

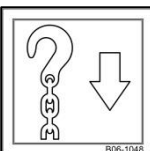

B06-1048
Indicates lashing eyes. These eyelets are used for secure attachment, for example, when transporting the machine on a truck.

4.2.1.2 Drive



B06-0551
The drive speed of the propeller shaft is:
max. 540 min-1!
(Depends on vehicle type, see ID plate)

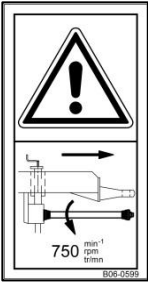

B06-0599
The drive speed of the propeller shaft is:
max. 750 min-1!
(Depends on vehicle type, see ID plate)



B06-0538
The drive speed of the propeller shaft is:
max. 1000 min-1!
(Depends on vehicle type, see ID plate)



B06-0550
Do not stand near the drive shaft. Danger of injury!

4.2.1.3 Scraper floor



B06-0544
Never enter cargo area if drive is engaged and motor is running!

4.2.1.4 Hydraulic



B06-0548

Be careful of high-pressure liquid leaks. Observe notice in technical handbook!

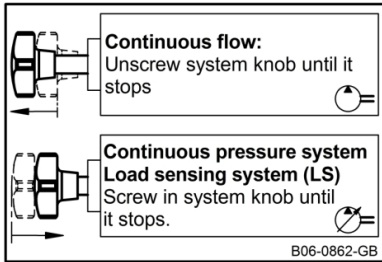

B06-0862

Constant current system:
Unscrew knob until it stops

Constant pressure system / Load-sensing system (LS):
Screw in knob until it stops

B06-0862-GB

4.2.1.5 Tailgate



B06-1022

Position shut-off valve of the tailgate.
In this position the tailgate is locked and the position cannot be accidentally changed.

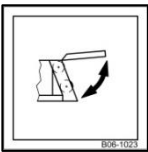

B06-1023

Position shut-off valve of the tailgate.
In this position the tailgate is not locked and can be opened and closed.

4.2.1.6 Chassis- Tandem axle unit

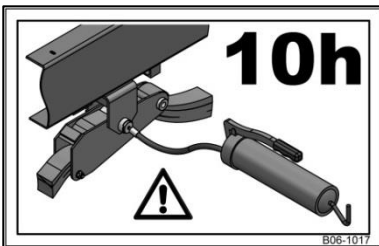

B06-1017

On all vehicles with a tandem axle unit and a lubricated middle rocker the lubrication pin in the middle spring saddle must be lubricated every 10 operating hours to ensure proper function and to reduce wear.

4.2.1.7 Silage Trailer

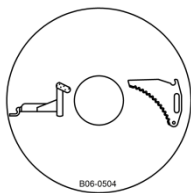

B06-0504
Vehicle side controls
left: drawbar
right: cutting unit

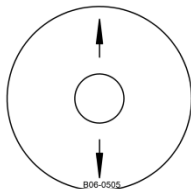

B06-0505
Vehicle side controls
up: raise drawbar /
cutting unit on
down: lower drawbar
cutting unit off



B06 0606
Never reach into the pick-up area, as long as the tractor engine is running when the PTO is on.

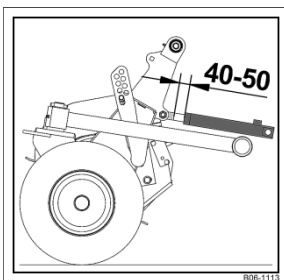

B06-1113
For an optimum pick-up operating height, the pick-up cylinder reference dimension must be correct:

- 40 - 50 mm

4.3 General safety and accident prevention regulations

4.3.1 Basic rules

- Inspect vehicle for road and operation readiness before each start-up.
- In addition to the instructions in this manual, also observe general safety and accident prevention regulations.
- Observe relevant regulations when using public roads.
- Familiarize yourself with all equipment and operating elements as well as their functions before beginning operation. When work has begun it is too late!
- Prior to each start-up, make sure that no one is in the immediate area (especially children!). Ensure there is adequate visibility e.g. when reversing (a ground guide may be necessary).
- The operator must wear tight-fitting clothing. Loose fitting clothing must be avoided.
- To avoid fire risk, keep the vehicle clean.



- Carrying and transport of persons is prohibited unless appropriate seats are available.
- Special care must be taken when working on the vehicle, and such work must only be performed when the scraper floor and dosing roller drive and the engine are off. Pull the ignition key.
- Regularly check guards for wear and replace if necessary.
- It is important to ensure that unauthorized persons are kept away from the vehicle.
- Ensure that all protective equipment is in place and in the proper position before operating the vehicle.
- During vehicle operation, the continuous sound pressure level is not higher than 70 dB(A). This continuous sound level was measured at a distance of 1 metre. The vehicle was powered by an electric motor connected to the drive shaft.

4.3.2 Driving

- Couple the trailer and equipment correctly. Handling, steering and braking ability are influenced by attachments, trailers and ballast weight. Therefore, ensure there is sufficient steering and braking ability.
- Observe permissible axle loads and gross weights!
- Regularly check the air pressure. Observe prescribed air pressure.
- During vehicle operation, the continuous sound pressure level is not higher than 70 dB(A).
- The vehicle may be used up to an angle of inclination of 10° across the slope. If this is exceeded, there is danger of tipping!

4.3.3 Road traffic regulations

The following, if applicable, as well as any other country-specific regulations must be observed:

- Authorization from the respective national road and traffic authorities is required to drive the vehicle on public roads.
- Agricultural trailers up to 25 km/h do not require registration
- Agricultural trailers faster than 25 km/h require registration (licence plate and liability insurance)
- Vehicles used for commercial purposes (up to and over 25 km/h) require registration

4.3.4 Coupling, loading and transport

- Use only specified connections to couple the vehicle.
- Be especially careful when coupling the vehicle.



Secure the vehicle against rolling prior to uncoupling (parking brake, wheel chocks).



Do not stand in the movement range of the drawbar.

- Ensure that all protective equipment is in place and in the proper position before operating the vehicle.
- Unevenly loaded trailers can tip, especially when uncoupled. Ensure sufficient nose weight. Minimum nose weight in the uncoupled state is 200 kg.
- If the vehicle is only partially loaded, tractor manoeuvrability could be impaired. In this case, drive with extreme caution.
- When the vehicle is coupled, ensure that the steering on the front tractor axle is not impaired by observing the nose weight.
- Observe permissible axle loads and gross weights! The weights given on the vehicle are binding. Ensure there is sufficient steering and braking ability.
- Avoid sudden cornering in ascents and descents, as well as driving across a slope. Adjust the driving speed according to conditions.
- Park the vehicle only when unladen. The parking surface must not exceed an incline of 7°. When parking, apply the parking brake and correctly place the wheel chocks.
- Caution: Tipping hazard!
The vehicle's maximum permitted angle of inclination perpendicular to the direction of travel is 10°

4.3.5 PTO operation

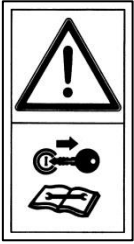

Connect and disconnect the PTO cardan shaft only when the engine is off and the ignition key has been removed.

- Never start up the PTO cardan shaft when the engine is not running.



When working on the PTO shaft itself, there must be no people in the area of the rotating PTO or PTO cardan shafts.

- PTO cardan shaft guard tube and guard cone as well as the PTO guard shield must be mounted and in proper condition!



After the power has been switched off, the driven unit can continue to run due to its momentum. During this time, keep a safe distance. Only approach the unit when the drive has come to a complete stop.

- Overload or overrunning clutches must be mounted on the vehicle. The clutch can be mounted on the tractor only if it is covered by the tractor's guard.

4.3.6 Hydraulic system

- The hydraulic system is under high pressure.
- The cutting unit hydraulics is equipped with a hydraulic accumulator. It can be under pressure even when the hydraulic system is unpressurized!
- When connecting hydraulic cylinders and motors, ensure that only the specified hydraulic hose fittings are used.
- When connecting hydraulic hoses to the tractor hydraulic system, ensure that the hoses are not under pressure on the tractor side and trailer side.
- When hydraulic function connections between the tractor and trailer are made, mark the hydraulic connectors and sockets to rule out operating errors. If the connections are reversed, the opposite function will be executed (e.g. lifting / lowering) – risk of accidents!
- Inspect hydraulic hoses regularly and replace if damaged or worn. Hydraulic hoses are subject to ageing. They become brittle with time and no longer meet the requirements. Persons can be injured by sudden high pressure hydraulic oil leaks. For this reason, hydraulic hoses must be replaced, at the latest, 4 years after delivery of the vehicle, and every 4 years thereafter. The replacement hoses must meet the requirements of the manufacturer.
- To avoid injury, use proper equipment when inspecting for leaks.



Fluids (hydraulic oil) escaping under high pressure can penetrate the skin and cause serious injury!
In case of injury, consult a doctor immediately! Risk of infection!

- Prior to working on the hydraulic system, lower the equipment, depressurize the system and switch the engine off.
- Only qualified personnel may carry out repair work on the hydraulic system.
- Only mineral hydraulic oil with the specification ISO VG 46 or equivalent may be used. Biodegradable oil must not be used for technical reasons.
- Hydraulic oil must not get into the soil. Dispose of used oil in accordance with local requirements. In case of disposal problems, consult your oil supplier. Keep hydraulic oil out of the reach of children.

4.3.7 Brakes and tyres

- Check the brakes before every use.
- A thorough brake system inspection is to be conducted on a regular basis.
- Adjustments and repairs to the brake system may only be carried out by a specialist garage or an authorized brake service contractor.
- When working on the tyres, the trailer must be safely parked and secured against rolling (wheel chocks).
- When tyres are defective, the vehicle must be raised to change the tyres only when it is unladen. When changing tyres, lace a jack under the affected axle. Then the trailer can be raised and the wheel can be changed (always secure the trailer against rolling). Fitting tyres and wheels requires sufficient knowledge and the right tools.
- Repair work on tyres and wheels may only be performed by qualified personnel with appropriate tools.
- Check tyre pressure regularly. Observe the specified air pressure.



Attention! Retighten wheel nuts:

- after the first 50 km
- after the next 150 km
- after the next 400 km

In the first few weeks of use, check the vehicle wheel nuts for tightness every day. During further operation, check the wheel nuts for tightness once a week.

4.3.8 Maintenance



Repairs, maintenance, cleaning and troubleshooting must only be carried out when the drive has been switched off and the engine is not running! Remove the tractor ignition key.

Regularly check nuts, screws and bolts for tightness.

If maintenance work is carried out in a raised position, always secure the vehicle with suitable support elements.

- When replacing equipment, always use suitable tools and wear work gloves.
- Fluids (hydraulic oil) escaping under high pressure can penetrate the skin and cause serious injury. In the event of injury, consult a doctor immediately, as there is a risk of serious infection.
- Dispose of oil, grease and filters appropriately.
- Fitting tyres and wheels requires sufficient knowledge and the right tools.
- Retighten wheel nuts after several hours of operation.
- Always switch the power supply off before working on the electrical system.
- Guards that are subject to wear must be inspected regularly and promptly replaced if necessary.
- Spare parts must at least meet the manufacturer's technical requirements. This is ensured by using original spare parts.
- When performing arc-welding on a tractor and or attached devices, disconnect the generator and battery cables.

4.4 Important information for vehicle operation

- The length of the PTO cardan shaft must be adapted to the tractor being used. Observe the drive shaft manufacturer's maintenance and installation instructions.
Max. 1000 rpm
- Raise the jack stand and lock it in place prior to operation.
- Set pick-up drum to the right working height!
- Adapt the size of the swath and the driving speed to the existing operating conditions!
- Take up load only in the direction of mowing!
- Only switch rotor, pick-up and dosing roller drive at standstill!
Observe the note in these operating instructions!
- Do not overload the vehicle! The specified gross weight is binding!
- Note the optical filling level indicator while loading!
This avoids blockage of the dosing rollers!
- When loading, take care not to exceed the permissible gross weight.
- Always ensure that the knives of the cutting unit are in a sharpened condition!
- Never push the loader wagon backwards on the unloaded goods.
Risk of breakage for the scraper floor!
- Only bend the high-lift drawbar as much as needed when driving the flat silo!
- In the driving position of the pick-up this must be secured by shutting off the oil supply to the pick-up cylinder!
- Lock the valve!
- The vehicle should be thoroughly lubricated regularly. See lubrication marking.
Observe the [\[Lubrication schedule\]](#)
- Retighten the wheel nuts on the wheels after several hours of operation; see section [\[Brakes and tyres\]](#)
- Also check that all major threaded connections are tight after the first hours of operation.
- Regularly check the drive chains:
Pick-up drive, drive of the dosing rollers and feed chains! - Retension if necessary (do not over-tighten!).
- Note in particular the operating information in the operating instructions for the [\[Scraper floor\]](#), the [\[Pick-up\]](#) and the [\[Cutting unit\]](#)!
- Observe the accident prevention regulations of the agricultural safety associations.
- Nobody must be in the danger zone when working with the vehicle.
- When working with or on the vehicle, wear personal protective equipment (e.g. gloves).
- Climbing onto the vehicle during operation or driving is prohibited.

4.5 Other hazards

- There is a danger of being crushed when raising and lowering the jack stand.
- There is also danger of being crushed when closing guards.
- When driving over rough terrain, there is danger of being crushed due to the reduction of the clearance between the tyre and frame.
- There is a danger of being crushed between the scraper floor chain and sprockets.
- There is a danger of being crushed when opening and closing the tailgate.
- There is a risk of being crushed when operating the high-lift drawbar
- There is a risk of being crushed when operating the knife bar

4.6 Safety instructions

Subsequent installation of electrical and electronic equipment and / or components

The vehicle is equipped with electronic components and assemblies whose function may be affected by electromagnetic emissions from other devices. Such affects can be hazardous to persons if the following safety instructions are not observed.



- If electrical and electronic equipment and / or components are subsequently installed in the vehicle with a connection to the electrical system, the user must verify at their own responsibility whether the installation causes interference with the vehicle electronics or other components.
- Make sure that subsequently installed electrical and electronic components meet the requirements of the current version of EMC Directive 89/336/EEC and that they carry the CE symbol.
- For wiring and installation as well as the max. allowable power draw, observe the machine manufacturer's installation instructions.

5 Functions and settings

Chapter “Functions and settings” contains information about the vehicle's design. It describes the vehicle's functions, handling and procedures for setting and operating the vehicle's components and functions.

The components and vehicle functions listed in the operating instructions may differ from the vehicle standard equipment and are available as optional features in some cases. Since these operating instructions are general, various equipment options can be listed that are not available for your vehicle. This also applies to illustrations. Images, drawings and 3D illustrations in these operating instructions do not always represent the exact vehicle type. However, the information which refers to the illustrations always corresponds to the vehicle type in this document.

	WARNING!
	<p>Failure to observe the safety instructions may result in serious injury or death.</p> <ul style="list-style-type: none"> • In order to prevent accidents, the operator of the vehicle must read and observe the safety instructions in the “Safety” chapter.

	WARNING!
	<p>There is a danger of crushing, shearing, cutting, severing, trapping, entanglement, drawing in, catching and impact for people when reaching into or working on the vehicle.</p> <p>These dangers can arise when</p> <ul style="list-style-type: none"> - the unsecured tractor and the vehicle roll away unintentionally, - driven tools and drives are not switched off, - hydraulic functions are unintentionally performed, - tools or parts of the vehicle are driven, - the tractor's engine is unintentionally started, - raised parts of the vehicle unintentionally lower, <p>These dangers exist during all work on the vehicle through unintentional contact with driven, unsecured tools and drives, which may run on after being switched off, and through raised, unsecured parts of the vehicle.</p> <ul style="list-style-type: none"> • Before any work on the vehicle, such as making adjustments or eliminating faults, the vehicle must be secured against unintentional rolling and starting. <p>  Observe the notes and instructions in the operating instructions, chapter “Commissioning”, section “Securing the vehicle against unintentional rolling and starting”. </p>

5.1 Vehicle functions

5.1.1 Loading functions

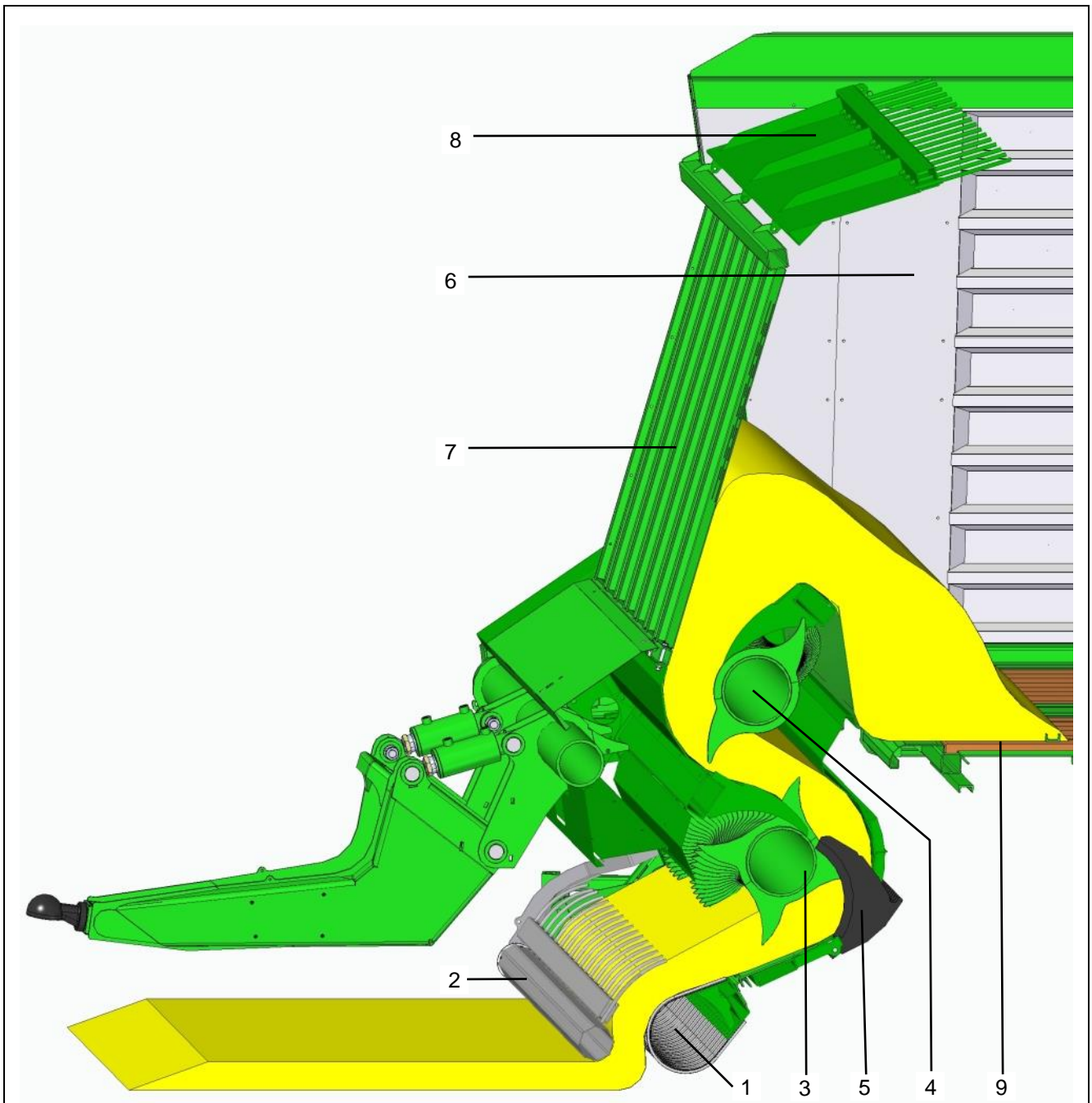

Image 8: Loading

20180426-103001-BTA

1	Pick-up	6	Cargo space
2	Swath roller	7	Front wall
3	Cutting rotor	8	Filler hood
4	Press rotor	9	Scraper floor
5	Cutting unit		

Description:

The load is picked up off the ground with a pick-up with spring-loaded tines (Image 8 / pos. 1) fitted to the front of the vehicle. The swath roller (Image 8 / pos. 2) ensures even take-up. The pick-up (Image 8 / pos. 1) transports the load to the conveyor unit. The cutting rotor (Image 8 / pos. 3) with spirally arranged rotor teeth transports the load continuously through the conveying channel to the knives of the cutting unit (Image 8 / pos. 5). A pre-compaction takes place. In the conveying channel, the knives of the cutting unit (Image 8 / pos. 5) cut the load to a variable length determined by the knives of the cutting unit (Image 8 / pos. 5). The press rotor (Image 8 / pos. 4) takes the cut load and conveys it highly compacted without crushing and pulping into the cargo space (Image 8 / pos. 6).

The cargo space (Image 8 / pos. 6) can be confined towards the top by a front wall (Image 8 / pos. 7) with filler hood (Image 8 / pos. 8) for a greater compaction of the material by the press rotor (Image 8 / pos. 4). The floor of the cargo space (Image 8 / pos. 6) is a scraper floor (Image 8 / pos. 9) that conveys the material to the rear of the vehicle and ensures quick unloading.



For detailed information about the vehicle elements mentioned in this section, their functions and associated handling, and instructions and notes for safe operation of the vehicle, see chapters "Functions and settings", "Operation" and "Use".

5.1.2 Unloading functions

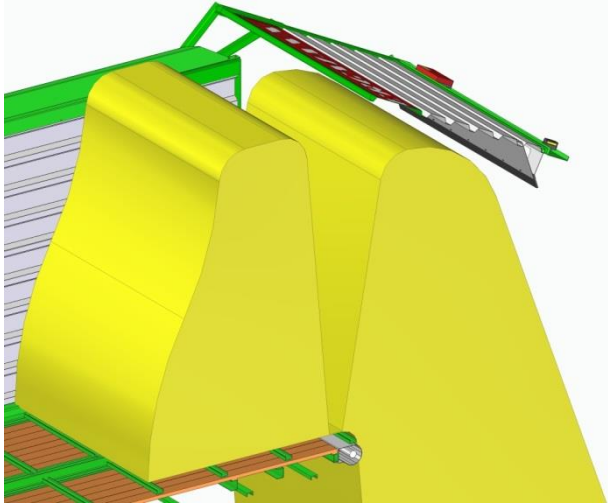
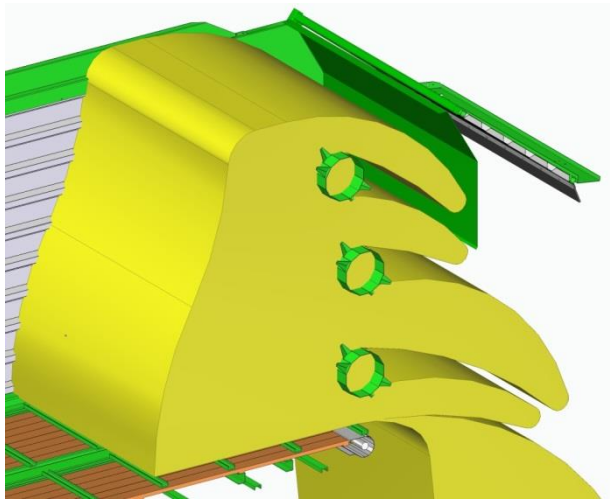
Type K vehicles	Type S vehicles
	
<p>Image 9: Unloading (type K) 20180426-140501-BTA</p>	<p>Image 10: Unloading (type S) 20180426-112701-BTA</p>
<p><u>Description:</u> On type "K" vehicles, the rear of the cargo space is confined by the tailgate. During unloading, the scraper floor conveys the material to the rear of the vehicle, where it is precisely discharged through the opened tailgate in a targeted manner.</p>	<p><u>Description:</u> Type "S" vehicles are equipped with a dosing unit. During unloading, the scraper floor conveys the crop to the rear of the vehicle. Dosing rollers (3 pce.) of the dosing unit loosen the material and, through the opened tailgate, ensure even unloading, e.g. into bunker silos or in precise points in stables.</p>



For detailed information about the vehicle elements mentioned in this section, their functions and associated handling, and instructions and notes for safe operation of the vehicle, see chapters "Functions and settings", "Operation" and "Use".

5.2 Drawbar

The drawbar is located on the front side of the machine. The coupling unit on the drawbar is coupled with the hitch on the tractor.



Possible coupling units are shown in the following sections.

Type:	Top coupling
Equipment:	With hydraulic drawbar adjuster
Drawbar:	Various drawbars possible

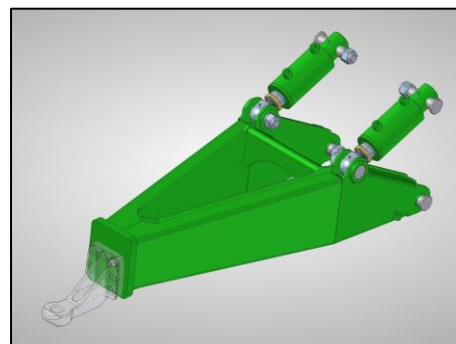

Image 11: Top coupling

Type:	Bottom coupling
Equipment:	With hydraulic drawbar adjuster
Drawbar:	Various drawbars possible

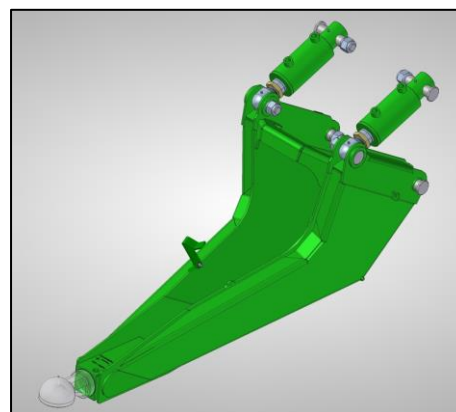

Image 12: Bottom coupling

5.2.1 Changing the drawbar

When adapting to the tractor and during maintenance of the vehicle, the drawbar may have to be changed.



Observe the notes and instructions in the operating instructions, chapter "Commissioning", section "Adapting to the tractor" / "Changing the drawbar".

5.2.2 Drawbar Adjustment (Hydraulic)

On vehicles with a hydraulically adjustable drawbar, the drawbar height can be adjusted

- to tractor height while uncoupled using the cylinders on the drawbar (Image 13).

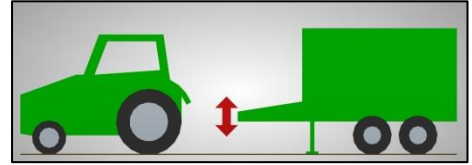

Image 13: Drawbar adjustment

- while uncoupled to adapt the drawbar height to height of the tractor (Image 14).

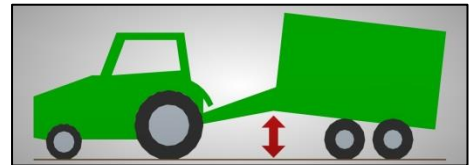



Image 14: Drawbar Adjustment

Operation depends on vehicle configuration and on the hydraulic system. The procedure for adjusting the drawbar can be seen in the following sections.

	WARNING!
	<p>Fingers or hands can be crushed while the drawbar is being raised or lowered!</p> <ul style="list-style-type: none"> • When lifting or lowering the hydraulic drawbar, ensure that no one is in the danger area. • Do not reach between moving components!

	WARNING!
	<p>When extending working elements damage can be caused to the vehicle or accidents can occur if the total height is not observed!</p> <p>This can cause accidents or severe damage to the machine.</p> <ul style="list-style-type: none"> • Ensure that the vehicle does not exceed the maximum height of 4.00 meters when driving on public roads.

E-controls (operated using terminal)

The drawbar is operated hydraulically using the terminal. Proceed as follows:

- Couple the hydraulic supply lines from the control block on the respective supply system to the appropriate tractor connections.



For this, observe the notices and instructions in the operating instructions in chapter "Functions and Settings" in the Hydraulics" and the "Coupling the Hydraulic Supply Line" sections.

- Couple the supply lines and the connection lines to the terminal.
- Switch the terminal on.
- Move the drawbar into the desired position by activating the "Raise drawbar" / "Lower drawbar" function on the terminal.



For this, the notices and instructions in the operating instructions in the chapter "Operation" are to be observed.

5.2.2.1 Vehicle controls

A controller for operating the drawbar (Image 15) and the cutting unit is mounted on the side of the vehicle frame for easy operation (see chapter "Cutting Unit"). With this, the drawbar can be easily raised and lowered.

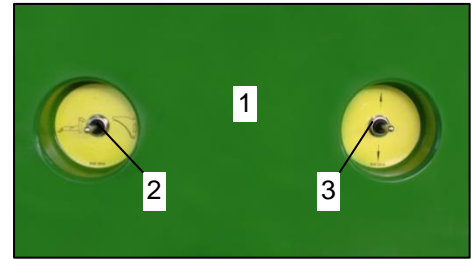

Image 15: Vehicle controls

Switch Pos. 2:

	<p>B06-0504</p>
	<p>Control Drawbar / Cutting Unit</p> <p>Toggle switch for operation of drawbar and cutting unit</p> <ul style="list-style-type: none"> • left: drawbar • right: cutting unit

Switch Pos. 3:

	<p>B06-0505</p>
	<p>Control Raising / Lowering</p> <p>Toggle switch for raising / lowering a machine function</p> <ul style="list-style-type: none"> • Above: Lift • Bottom: Lower

Procedure:

The drawbar is operated hydraulically using the vehicle controls. Proceed as follows:

- Couple the hydraulic supply lines from the control block on the respective supply system to the appropriate tractor connections.



For this, observe the notices and instructions in the operating instructions in chapter "Functions and Settings" in the Hydraulics" and the "Coupling the Hydraulic Supply Line" sections.

- To increase the clearance under the machine / to raise the drawbar, proceed as follows: Hold the left switch (Image 15 / Pos. 2) to the left (drawbar) and press the right switch up (Pos. 3) (upward arrow) until the vehicle reaches the desired height.
- If the front of the vehicle / drawbar is to be lowered, proceed as follows: Hold the left switch (/ Pos. 2) to the left (drawbar) and press the right switch down (Pos. 3) (downward arrow) until the vehicle reaches the desired height.

5.3 Parking device

Always observe the following:

- The parking surface must not exceed a maximum incline or slope of 7°.
- When parking, the parking brake must be applied and the wheel chocks positioned.
- During driving, the jack stand, jockey wheel, or towing jack (depending on the vehicle type and equipment) must be fully raised.
- Before parking the vehicle, you must remove any remnants of spread and loaded materials are removed from the rear cargo space.



WARNING!

Danger for people if unexpected vehicle movements occur due to component failure.

If the laden vehicle is parked on its parking devices or supports, there is a risk that these fail, causing the vehicle to tip over. This can cause injuries.

- Park the vehicle on its parking devices only when it is completely emptied.

5.3.1 Mechanical jack stand

The mechanical jack stand (Image 16 / pos. 1) supports the uncoupled trailer. The jack stand is of a hinged design and must be raised when the vehicle is hitched.

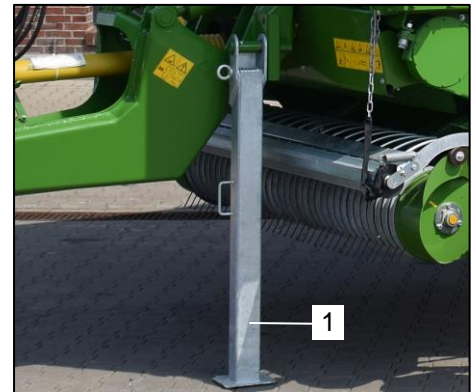

Image 16: Mechanical jack stand

5.3.1.1 Moving the jack stand into driving position / support position



WARNING!

There is a danger of crushing fingers and hands when lowering or raising the jack stand!

- When raising and lowering the jack stand, make sure that there are no people in the danger area.
- Do not reach between the movable components!

Driving position

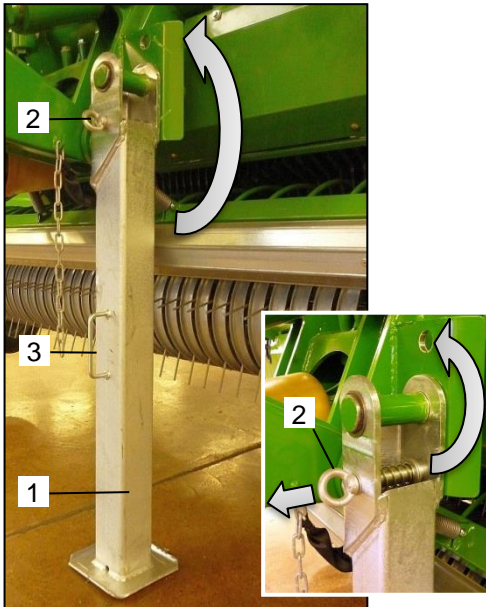

Image 17: Jack stand in driving position

Support position

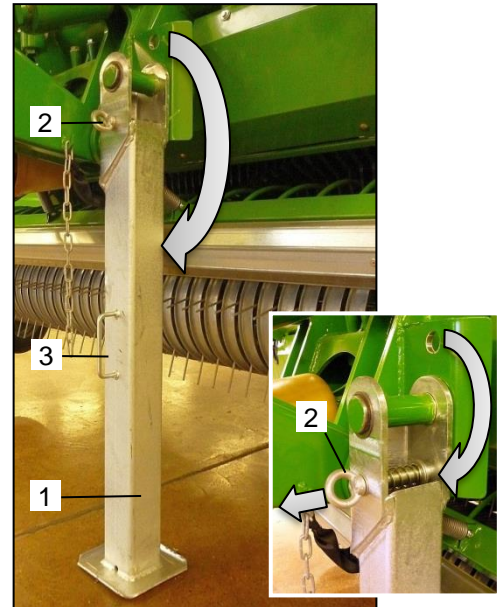

Image 18: Jack stand in support position

Application

Before driving off, the jack stand must be fully raised into its driving position with the vehicle coupled to the tractor.

Application

Before parking the vehicle, the jack stand must be fully lowered into its support position.

Procedure:

- Hold the jack stand (Image 17 / pos. 1) by the handle (Image 17 / pos. 3) and pull the locking bolt (Image 17 / pos. 2).
- Tilt the jack stand (Image 17 / pos. 1) to the side a little, so that the locking bolt (Image 17 / pos. 2) cannot re-engage and release the locking bolt (Image 17 / pos. 2).
- Holding the handle with both hands (Image 17 / pos. 3), raise the jack stand (Image 17 / pos. 1) into its fully raised position until the locking bolt (Image 17 / pos. 2) engages.
- Check whether the locking bolt (Image 17 / pos. 2) is securely engaged.

Procedure:

- Hold the jack stand (Image 18 / pos. 1) by the handle (Image 18 / pos. 3) and pull the locking bolt (Image 18 / pos. 2).
- Tilt the jack stand (Image 18 / pos. 1) to the side a little, so that the locking bolt (Image 18 / pos. 2) cannot re-engage and release the locking bolt (Image 18 / pos. 2).
- Holding the handle with both hands (Image 18 / pos. 3), lower the jack stand into its fully lowered position until the locking bolt (Image 18 / pos. 2) engages.
- Check whether the locking bolt (Image 18 / pos. 2) is securely engaged.

5.4 Pick-up

The pick-up (Image 19 / Pos.1) is mounted to the front of the vehicle. It gently picks up the material from the ground and continuously feeds it into the rotor in the conveyor unit.

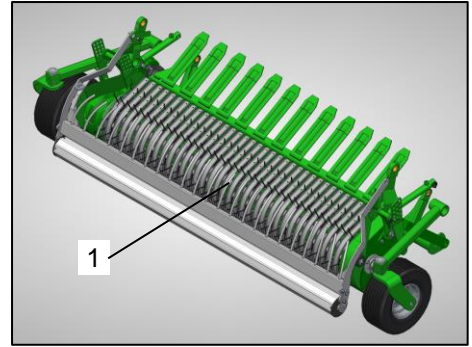

Image 19: Pick-Up

The pick-up area consists of the following individual components:

- pick-up
- guide wheels (sides)
- guide roller (rear)
- guide comb
- swath roller



For this, also observe the instructions and notices in the operating instructions in the following sections!

5.4.1 Setting the pick-up working height

The pick-up working height must be set correctly in order to make optimum use of the pick-ups operating range. This is done by adjusting the height of the guide wheels, which influences the distance between the ground and the pick-up's spring tines.



Observe the notes and instructions in the operating instructions, chapter "Commissioning", section "Adapting to the tractor" / "Setting the Pick-Up working height".

5.4.2 Locking / Unlocking the Pick-up



WARNING!

Danger of injury from unintentional pick-up movement!

If the pick-up is not secured, it can move when not intended. This can cause severe injury to persons.

- Always secure the pick-up against unintentional lowering before working on or under the pick-up.
- Keep people out of the tractor and vehicle danger areas and away from moving vehicle parts!

The hydraulic lines to the pick-up cylinders can be locked against unintended activation and lowering using a shut-off valve (Image 20 / Pos.1). The shut-off valve (Image 20 / Pos.1) is located on the control block.

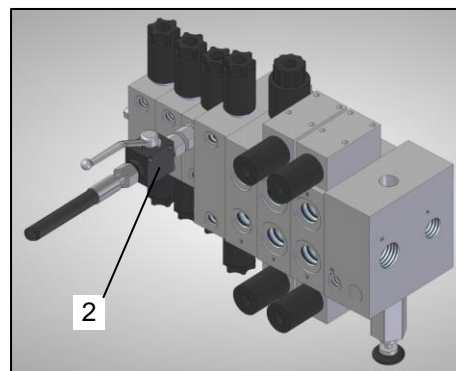

Image 20: Shut-off valve

Shut-off valve open

With the switch in this position the pick-up is not locked and can be raised and lowered.

This switch position must be selected under the following conditions:

- Before raising or lowering the pick-up.

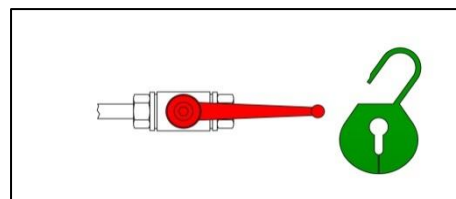

Image 21: Shut-off valve open

Shut-off valve closed

With the switch in this position the pick-up is locked and the position cannot be accidentally changed.

This switch position must be selected under the following conditions:

- When working under the raised pick-up.
- For transporting

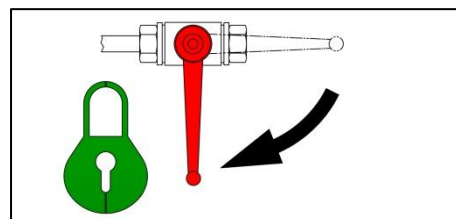



Image 22: Shut-off valve closed

5.4.3 Raising / Lowering the Pick-up

	<p>WARNING!</p>
	<p>Fingers or hands can be crushed when the pick-up is being raised or lowered!</p> <ul style="list-style-type: none"> • Ensure that no persons are in range of the pick-up during raising and lowering. • Do not reach between moving components!
	<p>NOTICE</p> <p>Raise the pick-up first when there is no more material on the pick-up or in the conveyor canal.</p>

E-controls (operated using terminal)

The pick-up is operated hydraulically using the terminal. Proceed as follows:

- Couple the hydraulic supply lines from the control block on the respective supply system to the appropriate tractor connections.



For this, observe the notices and instructions in the operating instructions in chapter "Functions and Settings" in the Hydraulics" and the "Coupling the Hydraulic Supply Line with E-controls" sections.

- Move the pick-up into the desired position by activating the "Raise pick-up" / "Lower pick-up" function on the terminal.



For this, the notices and instructions in the operating instructions in the chapter "Operation" are to be observed.

5.4.4 Starting / stopping pick-up

**WARNING!****Danger of drawing in and trapping of the whole body in case of driven equipment (pick-up and rotor)!**

These dangers can cause severe and potentially fatal injuries.

- Never reach into the area of the pick-up as long as the tractor is running with the PTO shaft connected.
- Keep people out of the tractor and vehicle danger areas and away from moving vehicle parts!

The pick-up's drive is powered by the tractor's PTO shaft. The cam clutch at the PTO cardan shaft to the tractor protects the drive from excessive forces. The pick-up is driven with a strong roller chain.

e-control (operation using terminal)

The pick-up is started and stopped by means of the tractor's PTO shaft. Do this as follows:

- Couple the hydraulic supply lines of the control block according to the respective supply system to the corresponding tractor connections.



Observe the notes and instructions in the operating instructions, chapter "Functions and settings", section "Hydraulic system" and "Coupling the hydraulic supply lines with e-control".

- While the PTO shaft is at a standstill, select the "Loading" menu at the terminal.



Observe the notes and instructions in the operating instructions, chapter "Operation".

- The pick-up starts up when the PTO shaft is switched on.
- The pick-up is switched off when the PTO shaft is switched off.

5.4.5 Guide Wheels

The vehicle is equipped with wide, air-filled tyres as guide wheels (Image 23 / Pos. 1) for use on less stable ground. Their follow-up steering protects the grass, e.g. in curves.

The pick-up working height must be set correctly in order to make optimum use of the pick-ups operating range. This is done by adjusting the height of the guide wheels, which influences the distance between the ground and the pick-up's spring tines.

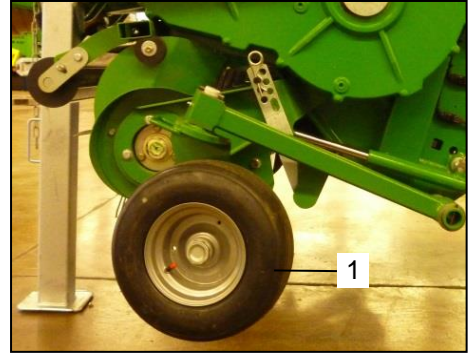

Image 23: Guide Wheels



For this, observe the notices and instructions in the operating instructions in chapter "Commissioning" in the "Adapting to the tractor" / "Setting the pick-up working height") section.

5.4.6 Guide roller

The guide roller behind the pick-up supports the guide wheel vertical guidance on uneven or soft ground.

The guide roller height setting depends on the distance between the ground and the spring tines. This means:

Pick-up working height = guide roller working height

When adjusting the guide roller working height, proceed as follows:

- Place the tractor and the empty vehicle on level, firm ground.
- Set the pick-up working height according to the guide wheel height



For this, observe the notices and instructions in the operating instructions in chapter "Functions and Settings" in the "Setting the pick-up working height") section.

- Remove the spring pins (Image 24 / Pos.1) on both sides of the guide roller frame in order to release the coupling rod (Image 24 / Pos.2) .
- Remove the coupling rod (Image 24 / Pos.2) from the locating pin on one side.
- Hold the guide wheel frame up and remove the coupling rod (Image 24 / Pos.2) from the locating pin on the other side.
- Adjust the height of the guide wheels as desired and hang the coupling rod (Image 24 / Pos.2) on the locating pin in the respective hole.
- Hang the coupling rod (Image 24 / Pos.2) on the locating pin in the respective hole on the other side.
- Secure the coupling rod (Image 24 / Pos.2) with the spring pin (Image 24 / Pos.2).

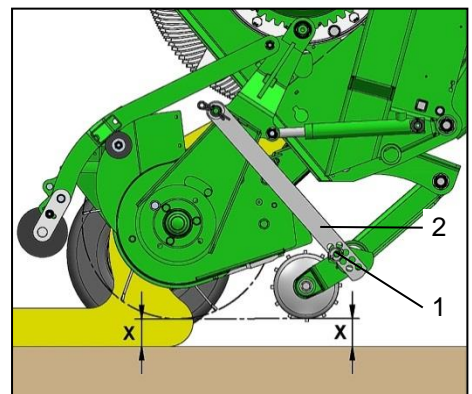

Image 24: Guide roller



NOTICE

Ensure that the guide wheels are in the same hole of the coupling rod on both sides and are thus at the same height on both sides.

5.4.7 Guide Comb and Swath Roller

The vehicle is equipped with a guide comb (Image 25 / Pos.1) and a swath roller (Image 25 / Pos.2), which are located above the pick-up. This ensures flawless pick up of short materials. The guide comb presses the feed against the pick-up tines, which prevents the feed from falling forward.

Depending on the swath thickness the guide comb (Image 25 / Pos.1) and swath roller (Image 25 / Pos.2) can be moved into the correct position by adjusting the chain length (Image 25 / Pos.3).

Thick swath:	Large distance between pick-up and guide comb / swath roller.
No swath:	Small distance between pick-up and guide comb / swath roller.

In most cases the guide comb (Image 25 / Pos.1) is guided by the swath roller (Image 25 / Pos.2). It lays on the swath and follows its contours. For flawless function the swath roller must turn freely.

5.4.7.1 Adjusting the height

	NOTICE
	<p>Setting of the guide comb / swath roller incorrectly can cause damage to the machine. The result can be bent or broken pick-up tines.</p> <ul style="list-style-type: none"> Ensure that the guide comb and the swath roller do not come into contact with the pick-up tines during operation.

When adjusting the working height, proceed as follows:

- Lower the pick-up until the guide wheels are on the ground.
- Set the desired distance using the chains on both sides of the vehicle (Image 25 / Pos.3).

	NOTICE
	<p>Check the setting</p> <ul style="list-style-type: none"> to ensure that the chains are the same length on both sides of the vehicle so that there is no contact with the pick-up tines.

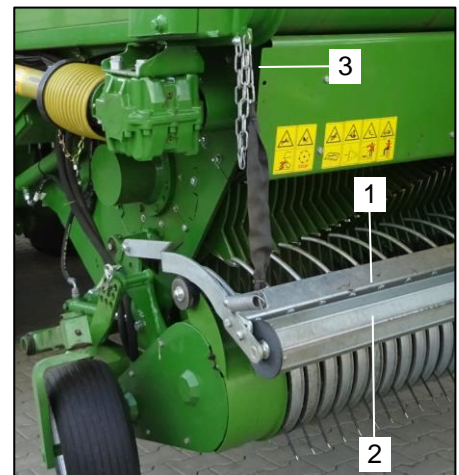

Image 25: Guide Comb & Swath Roller

5.4.7.2 Setting the angle of inclination

The swath roller (Image 26 / Pos.1) angle of inclination can be adjusted. This must be done as follows:

- Loosen the nuts (Image 26 / Pos.2) on both sides.
- Adjust the swath roller (Image 26 / Pos.1) in the slot.
- Tighten the nuts (Image 26 / Pos.2) on both sides.

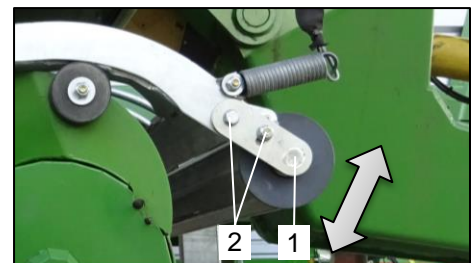

Image 26: Angle of inclination

5.5 Conveyor unit

The conveyor unit (Image 27 / pos. 1) is located in the chain of the material flow behind the pick-up. The cutting rotor with spirally arranged rotor teeth transports the load continuously through the conveying channel to the knives of the cutting unit. A pre-compaction takes place. The load is cut by the knives of the cutting unit in the conveying channel. The press rotor takes the cut load and conveys it highly compacted without crushing and pulping into the cargo space. Scrapers in the spaces of the rotor teeth prevent the blockage of the rotors.

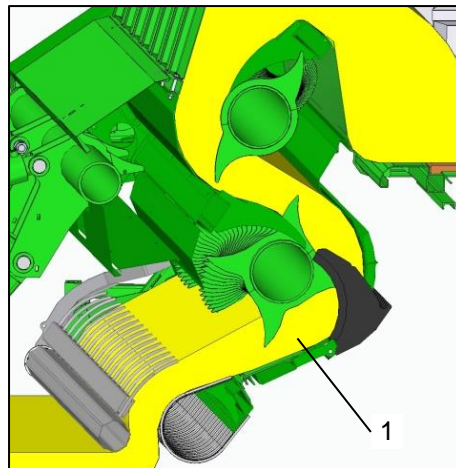

Image 27: Conveyor unit

5.5.1 Starting and stopping the conveyor unit



WARNING!

Danger of drawing in and trapping of the whole body in case of driven equipment (pick-up and rotor)!

These dangers can cause severe and potentially fatal injuries.

- Never reach into the area of the rotor as long as the tractor is running with the PTO shaft connected.
- Keep people out of the tractor and vehicle danger areas and away from moving vehicle parts!

The conveyor unit is driven mechanically via the tractor's PTO shaft. The cam clutch at the PTO cardan shaft to the tractor protects the drive from excessive forces. The rotors are driven with a strong roller chain.

E-Controls

The conveyor unit is switched on and off using the terminal and tractor PTO shaft. Proceed as follows:

- Couple the hydraulic supply lines from the control block on the respective supply system to the appropriate tractor connections.



For this, observe the notices and instructions in the operating instructions in chapter "Functions and Settings" in the Hydraulics" and the "Coupling the Hydraulic Supply Line with E-controls" sections.

- Select the "Load" menu in the terminal.



For this, the notices and instructions in the operating instructions in the chapter "Operation" are to be observed.

- When the PTO shaft is switched on, the conveyor unit is switched on.
- When the PTO shaft is switched off, the conveyor unit is switched off.



NOTICE

Do not switch the conveyor unit off until there is no more material in the conveyor channel.

5.6 Cutting unit

The cutting unit (Image 28 / pos. 1) is located behind the conveying channel. The cutting unit knives engage in the conveying channel and cut the crop during loading. Each knife is separately secured against foreign objects. After the protection mechanism has responded, the knife automatically returns to its cutting position. The response threshold is factory-set. The knives can be replaced without tools.

The knife bar can be moved into and out of the conveying channel hydraulically. This allows blockages in the conveyor unit to be conveniently cleared from the driver's seat in the tractor.

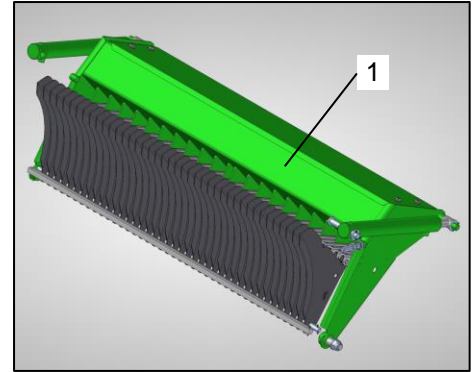

Image 28: Cutting unit

5.6.1 Cutting unit sensor

The cutting unit is fitted with sensors.



Observe the notes and instructions in the operating instructions, chapter "Functions and settings", section "Electrical system".

5.6.2 Raising / lowering the cutting unit



WARNING!

Danger of crushing fingers and hands when raising and lowering the cutting unit!

- When raising and lowering the cutting unit, make sure that there are no people in the danger area.
- Do not reach between the movable components!

The procedure for raising and lowering the cutting unit is described in the following sections.

e-control (operation using terminal)

The cutting unit is lowered (disengaged from the cutting groove) and raised (engaged in the cutting groove) from the terminal. When lowering, the cutting unit disengages to the point that the knives remain in the cutting groove by a small amount and are guided through the cutting tub. The disengagement travel can be set by adjusting a sensor on the cutting unit.



Observe the notes and instructions in the operating instructions, chapter “Functions and settings”, section “Electrical system” / “Sensors”.

The cutting unit is equipped with a monitor. If the cutting unit is not fully engaged, this is signalled on the terminal display.



Observe the notes and instructions in the operating instructions, chapter “Functions and settings”, section “Electrical system” / “Sensors”.

The cutting unit is moved hydraulically from the terminal. Do this as follows:

- Couple the hydraulic supply lines of the control block according to the respective supply system to the corresponding tractor connections.



Observe the notes and instructions in the operating instructions, chapter “Functions and settings”, section “Hydraulic system” and “Coupling the hydraulic supply lines with e-control”.

- Disengage the cutting unit with the “Lower cutting unit” function on the terminal.
- Operate the “Raise cutting unit” function on the terminal to engage the cutting unit.



Observe also the notes and instructions in the operating instructions, chapter “Operation”.

Control system on the vehicle

To simplify operation, a control system for operating the cutting unit (Image 29) and the drawbar (see section “Drawbar”) is located on the side on the vehicle frame. This can be used to conveniently engage and disengage the cutting unit.

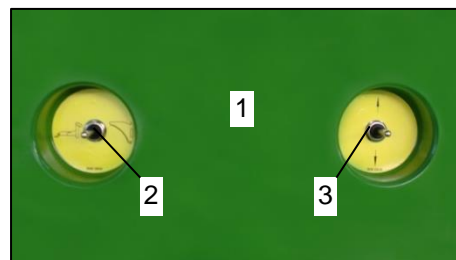

Image 29: Control system on the vehicle

Switch pos. 2:

	<p>B06-0504</p>
	<p>Control Drawbar / Cutting Unit Toggle switch for operation of drawbar and cutting unit</p> <ul style="list-style-type: none"> • left: drawbar • right: cutting unit

Switch pos. 3:

	<p>B06-0505</p>
	<p>Control Raising / Lowering Toggle switch for raising / lowering a machine function</p> <ul style="list-style-type: none"> • Above: Lift • Bottom: Lower

Procedure:

The cutting unit is moved hydraulically from the control system on the vehicle. Do this as follows:

- Couple the hydraulic supply lines of the control block according to the respective supply system to the corresponding tractor connections.



Observe the notes and instructions in the operating instructions, chapter “Functions and settings”, section “Hydraulic system” and “Coupling the hydraulic supply lines with e-control”.

- To lower the cutting unit (disengage it from the cutting groove), do the following: Hold the left switch (Image 29 / pos. 2) in its right position (cutting unit) and pull the right switch (pos. 3) down (down arrow) until the cutting unit is disengaged.
- To raise the cutting unit (engage it in the cutting groove), do the following: Hold the left switch (Image 29 / pos. 2) in its right position (cutting unit) and pull the right switch (pos. 3) up (up arrow) until the cutting unit is fully engaged. During raising, make sure that the knives correctly engage in the guide of the cutting tub.

5.7 Chassis

5.7.1 Follow-up steering

The follow-up steering minimizes the impact on the ground and growth when driving over it. When the follow-up steering axle is released, the wheels of the follow-up steering axle can adapt when cornering.

**WARNING!**

Risk of damage to the vehicle and accident risk if the setting instructions for the follow-up steering are not observed.

This can cause accidents and severe damage to the vehicle.

- Always observe the following instructions.

**NOTE**

The steering axle must not be run as follow-up steering; when driving, the steering axle must be locked,

- when driving on public roads.
- when driving on bumpy or otherwise uneven surfaces.
- when driving over bunker silos.
- when driving on inclines.
- if the lateral guide of the rigid axles alone cannot ensure safe vehicle operation.
- before reversing.



Observe the notes and instructions in the following sections.

Before locking the follow-up steering, the wheels must be brought into a straight position and hydraulically blocked. It can be helpful to slowly drive forwards during alignment.



Observe the notes and instructions in the following sections.

5.7.1.1 Locking / unlocking the follow-up steering

The procedure depends on the vehicle design and is carried out as follows:

e-control (operation using terminal)

- Couple the hydraulic supply lines of the control block according to the respective supply system to the corresponding tractor connections.



Observe the notes and instructions in the operating instructions, chapter “Functions and settings”, section “Hydraulics” and “Coupling the hydraulic supply lines”.

- Start terminal.
- The follow-up steering axle is unlocked by activating the “Unlock follow-up steering axle” function at the terminal. When the follow-up steering axle is unlocked, the indicator lamp at the terminal is lit.
- The follow-up steering axle is locked by activating the “Lock follow-up steering axle” function at the terminal. It can be helpful to slowly drive forwards during alignment. To lock the follow-up steering axle, operate the switch until the axle is completely straight and locked. The indicator lamp at the terminal goes out when the axle is locked.



Observe the notes and instructions in the operating instructions, chapter “Operation”.

5.8 Cargo Space



DANGER!

Danger of entire body being caught or pulled in when the system is running.

These hazards can cause severe injuries and possible death.

Never enter cargo space if drive is engaged and motor is running!

- Always switch off all drives, stop the engine and remove the ignition key before working in the cargo space.
- Before working on the vehicle, secure the tractor and the vehicle against unintentional rolling and starting!
- Keep people out of the tractor and vehicle danger areas and away from moving vehicle parts!



For this, the notices and instructions in the operating instructions in section "Commissioning" under "Securing vehicle against unintentional rolling and starting" are to be observed.

5.8.1 Cargo space access

Vehicles with dosing rollers:

The lateral access ladder with access door has to be used when working in the cargo space (e.g. for maintenance or repair work).



Also observe the notes and instructions in the operating instructions, chapter "Functions and settings", section "Access ladder with access door".

Vehicles without dosing rollers:

Entry via the opened tailgate is possible when work inside the cargo space (e.g. maintenance or repair work) is required.



Observe also the notes and instructions in the operating instructions, chapter "Functions and settings", section "Tailgate".

5.8.2 Ladder and Access Door

	NOTICE
	<p>Before driving:</p> <ul style="list-style-type: none"> • The access door must be closed, • and the ladder must be raised and fixed with the lever.

Lowering the ladder and opening the cargo space access door:

To lower the ladder (Image 30 / Pos.1) and open the access door (Image 30 / Pos. 2) proceed as follows:

- Hold the ladder with one hand (Image 30 / Pos.1) to prevent it from falling and press the safety (Pos. 3) back with the other hand and pull the lever (Image 30 / Pos.4) down to unlock it .
- Lower the ladder (Image 30 / Pos.1) with both hands until it rests completely on the the base step (Image 30 / Pos.5).
- In order to prevent unintended movement, fully open the access door (Image 30 / Pos. 2) and lock the door open with the lever (Image 30 / Pos.4) by moving it upwards.
- Use the handrail (Image 30 / Pos. 6) when entering or leaving the cargo space

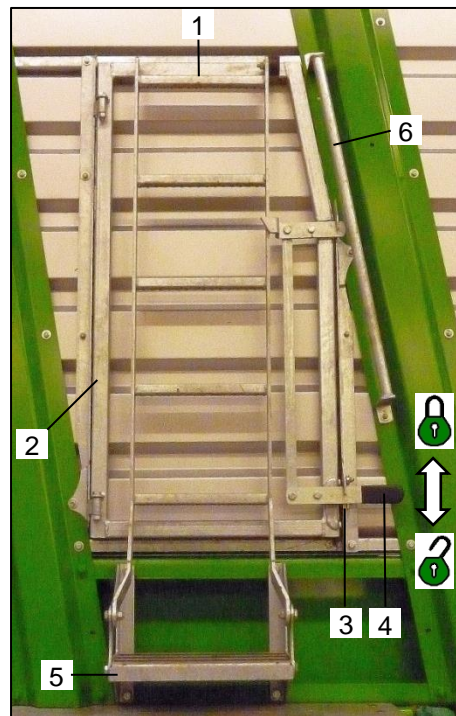

Image 30: Ladder and access door

Closing the cargo space door and raising the ladder.

To close the access door (Image 31 / Pos.2) and return the ladder (Image 31 / Pos.1) back the the uppermost position, proceed as follows:

- Pull the lever (Image 31 / Pos.4) down to release the access door (Image 31 / Pos.2) and close it completely. The lever then remains in the unlocked position .
- Raise the ladder (Image 31 / Pos.1) with both hands until it rests completely on access door (Image 31 / Pos.2).
- Lock the access door (Image 31 / Pos.2) and ladder (Image 31 / Pos.1) in place by pushing the lever (Image 31 / Pos.4) up . The safety latch (Image 31 / Pos.3) locks automatically, preventing accidental opening.

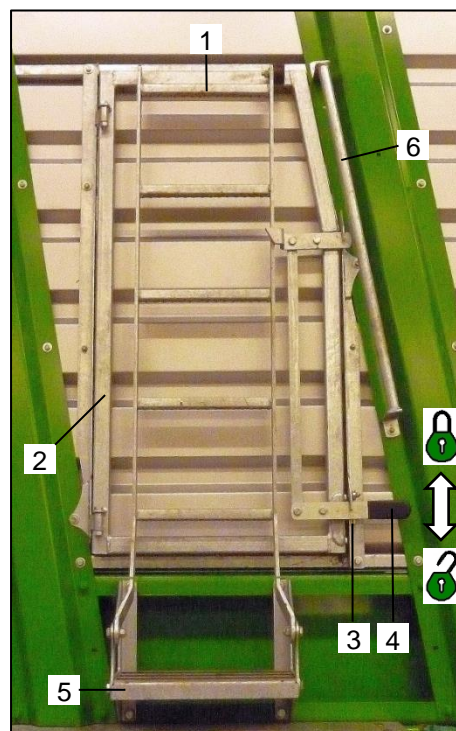

Image 31: Ladder and access door

5.8.3 Front wall sensor

The front wall is fitted with sensors.



Observe the notes and instructions in the operating instructions, chapter "Functions and settings", section "Electrical system".

5.8.4 Extension Walls

**WARNING!**

Damage can be caused to the vehicle or accidents can occur if the total weight is not observed!

- When using extension walls, ensure that the authorized axle loads and gross weights are not exceeded! The weights given on the vehicle are binding!

The side wall height and thus the loading volume of the machine can be optionally increased using extension walls.

These models can be fitted with the following extension walls:

- 150 mm / straight

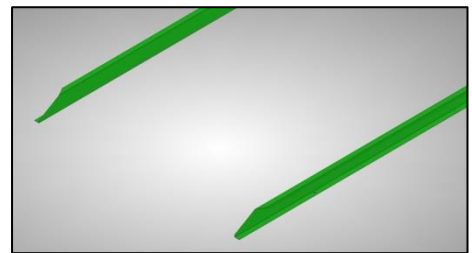

Image 32: Extension walls

5.9 Scraper floor



DANGER!

Danger of drawing in or catching of the whole body on driven tools.

These dangers can cause severe and potentially fatal injuries.

- Never step onto the cargo space when the drive is switched on and the engine is running.
- Always switch off all drives, stop the engine and remove the ignition key before working in the cargo space.
- Before performing any work on the vehicle, secure the tractor and the vehicle against unintentional rolling and starting!
- Keep people out of the tractor and vehicle danger areas and away from moving vehicle parts!



Observe the notes and instructions in the operating instructions, chapter "Commissioning", section "Securing the vehicle against unintentional rolling and starting".



WARNING!

Danger of crushing, shearing, drawing in and catching for people in the danger area of the running scraper floor, in particular at the reversing points!

- Instruct people to leave the danger area of the vehicle before starting up the scraper floor and maintain a sufficient safety distance from the running scraper floor.
- Always keep the scraper floor chains tensioned.



Observe the notes and instructions in the operating instructions, chapter "Functions and settings", section "Scraper floor" / "Tensioning systems".

5.9.1 Scraper floor chains

The scraper floor consists of 4 chain strands with transport bars. This design ensures the load is properly transported to the rear of the vehicle.

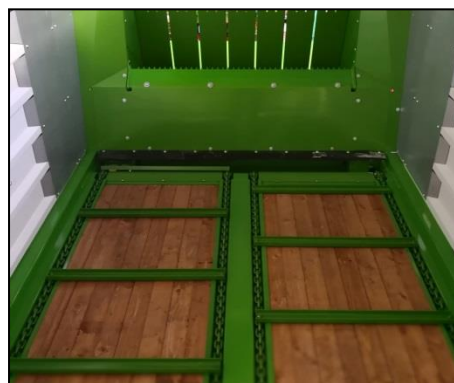

Image 33: Scraper floor chains

5.9.2 Tensioning systems

The scraper floor chains are secured to the front crossmember of the cargo space underneath the vehicle with tensioning systems.

The chain tension must be regularly checked.



Observe the notes and instructions in the operating instructions, chapter "Care and maintenance", section "Scraper floor".

5.9.3 Starting and stopping the scraper floor

The scraper floor is driven hydraulically through the tractor hydraulics. A hydraulic motor is driven by the controlled oil flow from the tractor and transmits its rotary motion to the feed shaft at the rear of the vehicle via a gearbox.

Operation depends on vehicle configuration and the hydraulic system. The procedure for starting and stopping the scraper floor is described in the following sections.

5.9.3.1 e-control with BCT / CCI / ISOBUS terminal

The scraper floor is started and stopped and its speed adjusted hydraulically from a terminal.



Image 34: e-control (comfort operation)

Do this as follows:

- Couple the hydraulic supply lines of the control block according to the respective supply system to the corresponding tractor connections.



Observe also the notes and instructions in the operating instructions, chapter “Functions and settings”, section “Hydraulic system” and “Coupling the hydraulic supply lines”.

- On the terminal, select the “unloading” menu.
- Open the tailgate by operating the “Raise tailgate” function on the terminal until the tailgate has reached the desired position.
- Vehicles with dosing rollers:
Start up the dosing rollers by operating the PTO.
- Start up the scraper floor in the unloading direction by operating the “start scraper floor” function on the terminal.
- Set the desired speed. For emptying the residues, you can increase the scraper floor speed.
- After unloading the crop, switch the tractor’s PTO off.
- Stop the scraper floor again by operating the “Stop scraper floor” function on the terminal.
- Close the tailgate by operating the “Lower tailgate” function on the terminal until the tailgate is fully closed.



Observe the notes and instructions in the operating instructions, chapter “Functions and settings”, section “Tailgate”.



Observe also the notes and instructions in the operating instructions, chapter “Operation”, section “CCI50, CCI200 and ISOBUS terminals”.

Scraper floor reversing**WARNING!**

Danger of damage to the vehicle and accident risk through faulty and excessive reversing of scraper floor!

This can cause accidents and severe damage to the vehicle.

- Reverse the scraper floor only when there is a free space between the load and the front wall.
- Reverse the scraper floor only briefly.
- Stop reversing as soon as the load starts touching the front wall.

If the clutch engages during unloading, the scraper floor can be reversed briefly. Do this as follows:

- Vehicles with dosing rollers:
Switching off the PTO stops the dosing rollers.
- Move the scraper floor towards the front wall by briefly operating the “Reverse scraper floor” function on the terminal.
- Vehicles with dosing rollers:
Restart the dosing rollers only after reversing the scraper floor via the PTO.



Observe also the notes and instructions in the operating instructions, chapter “Operation”, section “CCI50, CCI200 and ISOBUS terminals”.

5.10 Dosing unit

For even distribution when unloading on the flat silo, the vehicles can be equipped with a dosing unit (Image 35 / pos. 1) at their rear. This unit contains up to three aggressive dosing rollers.

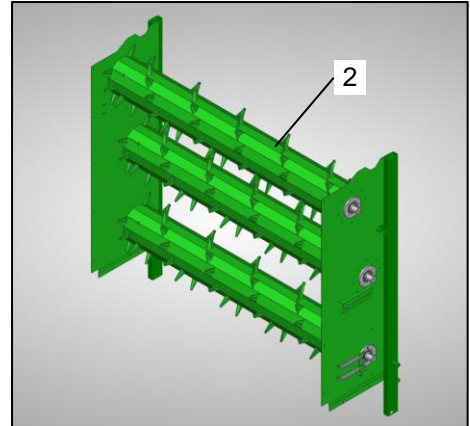

Image 35: Dosing unit

5.10.1 Dosing unit sensor

The dosing unit is fitted with sensors.



Observe the notes and instructions in the operating instructions, chapter “Functions and settings”, section “Sensors”.

5.10.2 Starting and stopping the dosing unit



CAUTION!

Danger of damage to the vehicle in the area of the dosing unit drive clutch when opening the tailgate when the PTO is running.

The dosing roller clutches engage automatically when the tailgate is opened. To prevent damage to the vehicle,

- first open the tailgate
- and switch on the PTO only once the tailgate is open.

The dosing unit is driven by the PTO shaft of the tractor and can be connected via dog clutch. The cam clutch in the PTO cardan shaft protects the drive from excessive forces. The dosing rollers are driven via a gearbox and roller chains.

Operation depends on vehicle configuration and the hydraulic system. The procedure for starting and stopping the dosing unit is described in the following sections.

e-control

The dosing unit is started and stopped from the terminal and with the tractor's PTO. Do this as follows:

- Couple the hydraulic supply lines of the control block according to the respective supply system to the corresponding tractor connections.



Observe the notes and instructions in the operating instructions, chapter "Functions and settings", section "Hydraulic system" and "Coupling the hydraulic supply lines with e-control".

- On the terminal, select the "unloading" menu.
- Open the tailgate with the "Raise tailgate" function.



Observe also the notes and instructions in the operating instructions, chapter "Operation".

- The dosing unit starts up when the PTO is switched on.
- The dosing unit stops when the PTO is switched off.
- Close the tailgate with the "Lower tailgate" function.

5.11 Tailgate

The tailgate is located at the back of the vehicle and closes off the cargo space.

5.11.1 Locking / unlocking the tailgate

	WARNING!
	<p>Risk of injury through unintentional tailgate movement!</p> <p>If the tailgate is not secured, it can move inadvertently. This can cause serious injuries.</p> <ul style="list-style-type: none"> Always secure the tailgate against unintentional lowering and operating before working on or under it. Keep people out of the danger area behind the vehicle and away from moving vehicle parts!

Position of the shut-off valve

The hydraulic line to the cylinders of the tailgate can be locked against unintentional operating and lowering with a shut-off valve (Image 36 / pos. 1). The shut-off valve (Image 36 / pos. 1) is located on the right side on the frame of the vehicle.

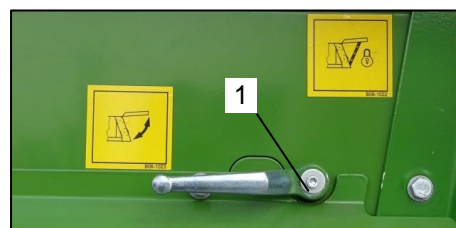
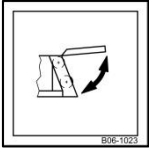

Image 36: Shut-off valve

Setting the shut-off valve

	B06-1022
	<p>Setting: Tailgate shut-off valve</p> <p>Before walking or standing under the raised tailgate, secure the tailgate against unintentional lowering and operating with the shut-off valve.</p>
	<p><u>Shut-off valve closed:</u></p> <p>(shut-off valve lever towards this sticker / perpendicular to hydraulic line)</p> <p>In this position, the tailgate is locked and cannot unintentionally move.</p> <p>This position must be selected under the following conditions:</p> <ul style="list-style-type: none"> When working under the raised tailgate.

	B06-1023
	<p>Setting: Tailgate shut-off valve</p> <p>Before walking or standing under the raised tailgate, secure the tailgate against unintentional lowering and operating with the shut-off valve.</p> <p><u>Shut-off valve opened</u></p> <p>(shut-off valve lever towards this sticker / parallel with hydraulic line)</p> <p>In this position, the tailgate is not locked and can be opened and closed.</p> <p>This position must be selected under the following conditions:</p> <ul style="list-style-type: none">• Before operating the tailgate.

5.11.2 Tailgate positions

Model K (without dosing rollers)

Opening width:	- The tailgate is completely open.
Use:	- Vehicles without dosing rollers
Advantages:	- Quick emptying of the cargo space.

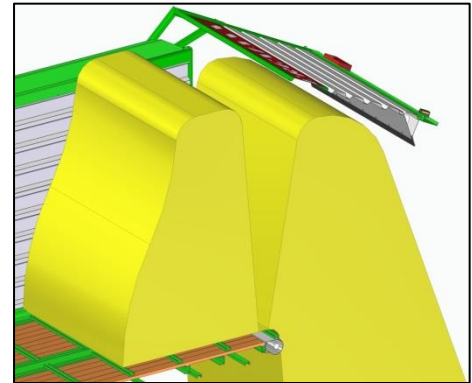

Image 37: Tailgate Model K

Model S (with dosing rollers)

Opening width:	- The tailgate is completely open.
Use:	- Vehicles with dosing rollers
Advantages:	- Targeted unloading of the load material in bunker silos and stables.

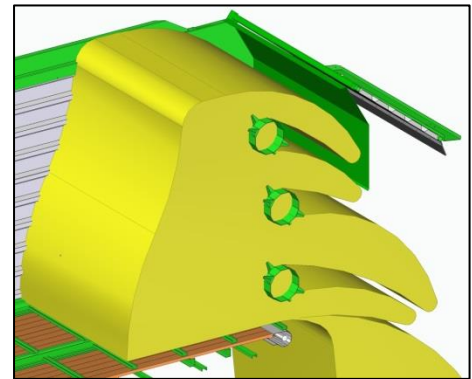







Image 38: Tailgate Model S

5.11.3 Raising / lowering the tailgate

	<p>WARNING!</p> <p>Danger of crushing the entire body when working underneath raised parts of the vehicle. This can cause severe and potentially fatal injuries.</p> <ul style="list-style-type: none"> • Enter the danger area only when the safety devices are engaged.
	<p>WARNING!</p> <p>There is a danger of crushing fingers and hands when lowering or raising the tailgate!</p> <ul style="list-style-type: none"> • When raising and lowering the tailgate, make sure that there are no people in the danger area. • Do not reach between the movable components!
	<p>WARNING!</p> <p>Danger of drawing in or catching of the whole body on driven tools! This can cause severe and potentially fatal injuries.</p> <ul style="list-style-type: none"> • Keep sufficient distance from rotating vehicle parts.
	<p>CAUTION!</p> <p>Danger of damage to the vehicle in the area of the dosing unit drive clutch when opening the tailgate when the PTO is running.</p> <p>The dosing roller clutches engage automatically when the tailgate is opened. To prevent damage to the vehicle,</p> <ul style="list-style-type: none"> • first open the tailgate • and switch on the PTO only once the tailgate is open.
	<p>CAUTION!</p> <p>Danger through falling material when the tailgate is open!</p> <p>When standing or working under the open tailgate, watch out for falling material.</p> <ul style="list-style-type: none"> • Using suitable aids, remove any loose material before standing under the opened tailgate.

Operation depends on vehicle configuration and the hydraulic system. The procedure for raising and lowering the tailgate is described in the following sections.

E-control (operation using terminal)

The tailgate is raised and lowered hydraulically from the terminal. Do this as follows:

- Couple the hydraulic supply lines of the control block according to the respective supply system to the corresponding tractor connections.



Observe the notes and instructions in the operating instructions, chapter “Functions and settings”, section “Hydraulics” and “Coupling the hydraulic supply lines”.

- For tailgates with mechanical lock:
 - Unlock the tailgate.
- Operate the “Raise tailgate” or “Lower tailgate” function on the terminal to move the tailgate into the desired position.



Observe also the notes and instructions in the operating instructions, chapter “Operation”.

- Lock the tailgate by closing the tailgate shut-off valve when performing repairs in the cargo space or under the opened tailgate.
- Having completed the work, unlock the tailgate.
- Close the tailgate with the “Lower tailgate” function on the terminal.
- For tailgates with mechanical lock:
 - Lock the tailgate.

5.11.4 Tailgate sensor

The tailgate is fitted with sensors depending on the vehicle equipment.



Observe the notes and instructions in the operating instructions, chapter “Functions and settings”, section “Electrical system”.

5.11.5 Tailgate as cargo space access**WARNING!****Risk of injury through unintentional tailgate movement!**

If the tailgate is not secured, it can move inadvertently. This can cause serious injuries.

- Always secure the tailgate against unintentional lowering and operating before working on or under it.
- Keep people out of the danger area behind the vehicle and away from moving vehicle parts!

**NOTE**

The tailgate must only be used as access to the cargo space when the vehicle is not equipped with a dosing unit with dosing rollers.

If the vehicle is equipped with an access ladder and a cargo space door, they have to be used as access to the cargo space.



Observe the notes and instructions in the operating instructions, chapter "Functions and settings", section "Cargo space" / "Access ladder and cargo space door".

Vehicles without dosing rollers:

Entry via the opened tailgate is possible when work inside the cargo space (e.g. maintenance or repair work) is required. Do this as follows:

- Open the tailgate.
- Lock the tailgate by closing the shut-off valve of the tailgate.
- To access the cargo space through the opened tail section, use steps that are secured against sliding and tripping.
- After leaving the cargo space, remove the steps from the vehicle.
- Unlock the tailgate by opening the shut-off valve of the tailgate.
- Close the tailgate.



Observe also the notes and instructions in the operating instructions, chapter "Functions and settings", section "Tailgate" / "Locking and unlocking tailgate" as well as "Tailgate" / "Opening and closing tailgate".

5.12 Cross conveyor belt

Vehicles with dosing rollers are optionally available with a cross conveyor belt. With the hydraulically driven cross conveyor belt (Image 39 / pos. 1) the load can be unloaded at the rear next to the vehicle, to spread, for example, the fodder in the stable. The operation of the cross conveyor belt is carried out by means of separate terminals. If the cross conveyor belt is not required, it can be easily stowed under the vehicle frame.



Image 39: Cross conveyor belt

5.12.1 Cross conveyor belt positions

Working position



Image 40: Cross conveyor belt working position

Application

The cross conveyor belt is fully extended and connected with the tailgate. The load can be unloaded at the rear next to the vehicle via the cross conveyor belt, to spread, for example, the fodder in the stable.

Parking position





Image 41: Cross conveyor belt parking position

Application

The cross conveyor belt is located under the vehicle frame. The tailgate can be freely opened and closed. This allows for targeted unloading of the load material in bunker silos and stables.

5.12.1.1 Bringing the cross conveyor belt in the working position

	<p>WARNING!</p>
<p>Risk of injury through movements of tractor and vehicle or of vehicle parts!</p> <ul style="list-style-type: none"> Before performing any work on the vehicle, secure the tractor and the vehicle against unintentional rolling and starting! Keep people out of the tractor and vehicle danger areas and away from moving vehicle parts! <p>  Observe the notes and instructions in the operating instructions, chapter "Commissioning", section "Securing the vehicle against unintentional rolling and starting". </p>	

	<p>WARNING!</p>
<p>There is a danger of crushing fingers and hand when the cross conveyor belt is converted into another position.</p> <ul style="list-style-type: none"> During conversion of the cross conveyor belt into another position make sure that no persons are in the danger area. Do not reach between the movable components! 	

Proceed as follows to bring the cross conveyor belt into the working position:

Converting the tailgate:

- Unlock the tailgate (Image 42 / pos. 1) by means of the shut-off valve.
- Remove the locking pins (Image 42 / pos. 3) at the lateral tie rods (Image 42 / pos. 2) on both vehicle sides.
- Release the tie rods (Image 42 / pos. 2) on both vehicle sides from the lower bolts. The tailgate (Image 42 / pos. 1) now swivels down and can be freely moved.
- Open the tailgate (Image 42 / pos. 1) until you can tighten the tie rods (Image 42 / pos. 2) at the upper bolts.
- Tighten the tie rods (Image 42 / pos. 2) on both vehicle sides at the upper bolts and secure them via locking pins (Image 42 / pos. 3).
- Lock the tailgate (Image 42 / pos. 1) by means of the shut-off valve.



Image 42: Converting the tailgate

Pulling out the cross conveyor belt:

- Unlock the cross conveyor belt (Image 43 / pos. 1) via the two levers (Image 43 / pos. 2).
- Pull the cross conveyor belt (Image 43 / pos. 1) under the vehicle frame all the way out up to the stop. The fasteners must engage audibly again. Check whether the cross conveyor belt (Image 43 / pos. 1) is fully locked.

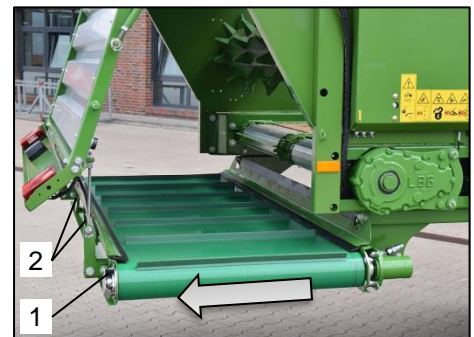

Image 43: Pulling out the cross conveyor belt

Connecting the cross conveyor belt with the tailgate:

- Mount the threaded rods (Image 44 / pos. 3) attached to the cross conveyor belt (Image 44 / pos. 1) on both vehicle sides in the brackets (Image 44 / pos. 4) at the tailgate (Image 44 / pos. 2).
- Firmly tighten the nuts (Image 44 / pos. 5).



If the cross conveyor belt does not run in parallel to the vehicle frame, the angle has to be adjusted. Observe the notes and instructions, chapter “Care and maintenance”, section “Cross conveyor belt / Setting the angle”.

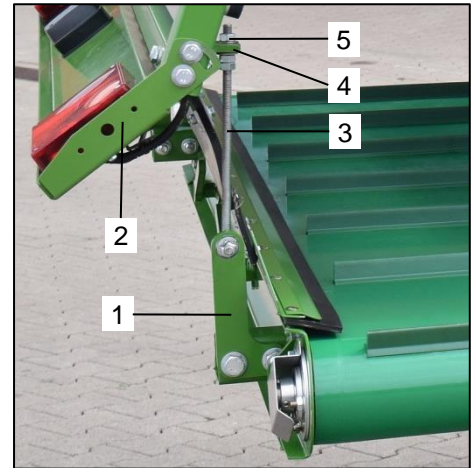

Image 44: Connecting the cross conveyor belt with the tailgate

Positioning the light bracket:

- Release the mounting screws (Image 45 / pos. 2) on both vehicle sides of the light bracket (Image 45 / pos. 1).
- Align the light bracket (Image 45 / pos. 1) vertically to the road surface / ground.
- Tighten the mounting screws (Image 45 / pos. 2) on both vehicle sides of the light bracket (Image 45 / pos. 1).

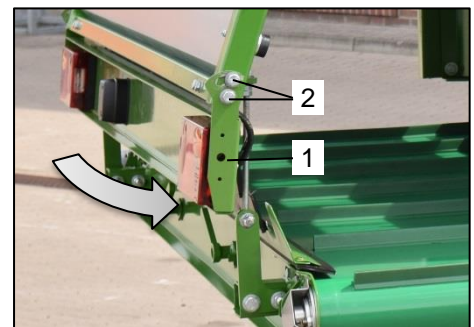

Image 45: Positioning the light bracket



Fitting the cover plates:

- Fit the cover plates (Image 46 / pos. 1) on both vehicle sides. To do this, use the supplied attaching parts. Firmly tighten the nuts at both vehicle sides (Image 46 / pos. 2).



Image 46: Fitting the cover plates

5.12.1.2 Bringing the cross conveyor belt in the parking position

	WARNING!
	<p>Risk of injury through movements of tractor and vehicle or of vehicle parts!</p> <ul style="list-style-type: none"> Before performing any work on the vehicle, secure the tractor and the vehicle against unintentional rolling and starting! Keep people out of the tractor and vehicle danger areas and away from moving vehicle parts! <p>  Observe the notes and instructions in the operating instructions, chapter "Commissioning", section "Securing the vehicle against unintentional rolling and starting". </p>

	WARNING!
	<p>There is a danger of crushing fingers and hand when the cross conveyor belt is converted into another position.</p> <ul style="list-style-type: none"> During conversion of the cross conveyor belt into another position make sure that no persons are in the danger area. Do not reach between the movable components!

Proceed as follows to bring the cross conveyor belt into the working position:

Removing the cover plates:

- Remove the cover plates (Image 47 / pos. 1) on both vehicle sides. To do this, release the nuts (Image 47 / pos. 2) on both vehicle sides.
- Store the cover plates and attaching parts in such a way that they are ready for the next use with the cross conveyor belt.



Image 47: Removing the cover plates

Release the light bracket:

- On both vehicle sides release the mounting screws (Image 48 / pos. 2) at the light bracket (Image 48 / pos. 1) so that the light bracket (Image 48 / pos. 1) can be freely moved.
- After conversion of the tailgate realign the light bracket (Image 48 / pos. 1). First proceed with the following steps.

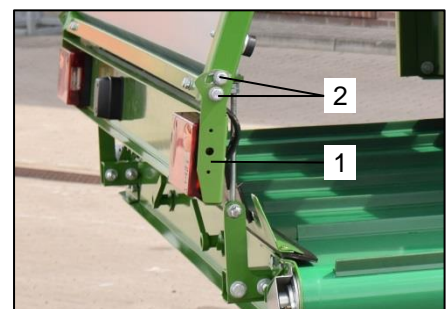

Image 48: Release the light bracket

Separating the cross conveyor belt from the tailgate:

- Release the nuts (Image 49 / pos. 5) on both vehicle sides.
- Remove the threaded rods (Image 49 / pos. 3) attached to the cross conveyor belt (Image 49 / pos. 1) on both vehicle sides from the brackets (Image 49 / pos. 4) at the tailgate (Image 49 / pos. 2).

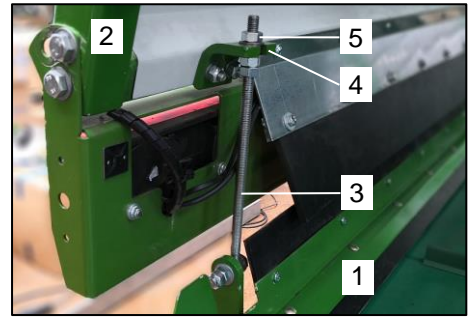

Image 49: Separating the cross conveyor belt from the tailgate

Sliding in the conveyor belt:

- Unlock the cross conveyor belt (Image 50 / pos. 1) via the two levers (Image 50 / pos. 2).
- Slide in the cross conveyor belt (Image 50 / pos. 1) under the vehicle frame up to the stop. The fasteners must engage audibly again. Check whether the cross conveyor belt (Image 50 / pos. 1) is fully locked.



Image 50: Sliding in the conveyor belt

Converting the tailgate:

- Unlock the tailgate (Image 51 / pos. 1) by means of the shut-off valve.
- Remove the locking pins (Image 51 / pos. 3) at the lateral tie rods (Image 51 / pos. 2) on both vehicle sides.
- Release the tie rods (Image 51 / pos. 2) on both vehicle sides from the upper bolts. The tailgate (Image 51 / pos. 1) now swivels down and can be freely moved.
- Close the tailgate (Image 51 / pos. 1) until you can tighten the tie rods (Image 51 / pos. 2) at the lower bolts.
- Tighten the tie rods (Image 51 / pos. 2) on both vehicle sides at the lower bolts and secure them via the locking pins (Image 51 / pos. 3).
- Lock the tailgate (Image 51 / pos. 1) by means of the shut-off valve.



Image 51: Converting the tailgate

Positioning the light bracket:

- Align the light bracket (Image 52 / pos. 1) vertically to the road surface / ground.
- Tighten the mounting screws (Image 52 / pos. 2) on both vehicle sides of the light bracket (Image 52 / pos. 1).

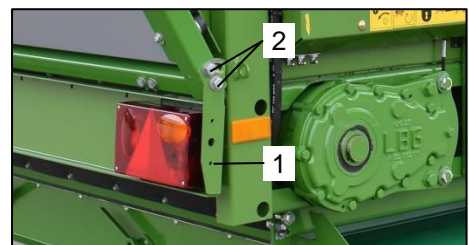

Image 52: Positioning the light bracket

5.12.2 Starting and stopping the cross conveyor belt



CAUTION!

There is a danger of damage to the vehicle when operating the cross conveyor belt although the cross conveyor belt is not in working position.

The cross conveyor belt must not be switched on when it is in driving position (under the vehicle frame).

- Bring the cross conveyor belt into the working position before you start it.



Observe the notes and instructions in the operating instructions, chapter "Functions and settings", section "Cross conveyor belt" / "Cross conveyor belt positions".

The cross conveyor belt is driven hydraulically through the tractor hydraulics. A hydraulic motor is driven by the oil flow from the tractor and transmits its rotary motion to the drive shaft of the cross conveyor belt.

Operation depends on vehicle configuration and the hydraulic system. The procedure for starting and stopping the cross conveyor belt is described in the following sections.

Manual control (operation through tractor control units)

Starting and stopping of the cross conveyor belt is effected hydraulically by means of the tractor's control units. Do this as follows:

- Couple the hydraulic supply lines for the "Starting and stopping the cross conveyor belt" function to the corresponding control units of the tractor.



Observe the notes and instructions in the operating instructions, chapter "Functions and settings", section "Hydraulics" and "Coupling the hydraulic supply lines".

- By activating the respective control unit at the tractor the cross conveyor belt is switched on in the corresponding direction.
- To switch off the cross conveyor belt, stop operation of the control valve for the cross conveyor belt.

e-control (operation using terminal)



DANGER!

Danger of drawing in or catching of the whole body in the case of driven tools when present in danger area!

- When operating the vehicle via the Terminal Pilotbox cross conveyor belt a safety distance of at least 850 mm to movable components of the vehicle must be kept.
- Keep people out of the tractor and machine danger areas and away from moving vehicle parts!
- Persons must be permanently in the field of view of the driver. The unloading procedure must be interrupted immediately if visual contact is lost. Stop immediately and immediately stop all drives.

The cross conveyor belt is started and stopped hydraulically from the terminal. Do this as follows:

- Couple the hydraulic supply lines of the control block according to the respective supply system to the corresponding tractor connections.
- Couple the hydraulic supply lines for the “Starting and stopping the cross conveyor belt” function to the corresponding control units of the tractor.



Observe the notes and instructions in the operating instructions, chapter “Functions and settings”, section “Hydraulics” and “Coupling the hydraulic supply lines”.

- Switch on the terminal Pilotbox cross conveyor belt.
- By activating the function “Cross conveyor belt left” / “Cross conveyor belt right” at the terminal you switch on the cross conveyor belt in the desired direction.
- To switch off the cross conveyor belt, bring the switch “Cross conveyor belt left” / “Cross conveyor belt right” to its middle position.
- Switch off the terminal.



Observe also the notes and instructions in the operating instructions, chapter “Operation”.

5.13 Lubrication



CAUTION!

Danger through escaping lubricants.

There is a risk of slipping and injury.

- During installation, operation, maintenance and repairs, watch out for escaping lubricant.
- Immediately seal any leaks.
- Avoid skin contact with oils, grease, cleaning agents and solvents.
- On injuries or burns through oils, cleaning agents or solvents immediately call a doctor.



CAUTION!

Lubricants can pollute waterways and the ground.

- Use and dispose of lubricants properly.
- Observe the regional laws and regulations on disposal.

5.13.1 Lubrication system for roller chains (conveyor unit / pick-up)

An automatic roller chain lubrication system (Image 53 / pos. 1) is optionally available.



Observe also the notes and instructions in the manufacturer's operating instructions for the supplied lubrication system.



Image 53: Lubrication system



WARNING!

Danger through system pressure / hydraulic pressure.

Lubrication systems are under high pressure during operation.

- Before starting installation, maintenance or repair work and before making modifications or repairs on the vehicle, lubrication systems must be depressurized.



NOTE

The lubrication system works automatically. A visual check of the lubricant flow in the lubrication lines should nevertheless be performed regularly.

- Check all lubrication points for sufficient grease supply every day!
- Top up grease at the grease nipples of the PTO cardan shaft and other grease nipples on moving components according to the lubrication schedule.

5.13.1.1 Lubrication pump

The lubrication pump (Image 54 / pos. 1) pumps the lubricant from the lubricant reservoir (Image 54 / pos. 2) to the downstream lubrication points or manifolds at a defined flow rate.

The lubricant reservoir (Image 54 / pos. 2) is made of transparent plastic and has fill level marks that allow a visual fill level check.

During operation, the stirrer blade in the lubricant reservoir (Image 54 / pos. 2) must rotate.



Image 54: Lubrication pump



Observe also the notes and instructions in the operating instructions, chapter “Care and maintenance”, section “Lubrication”.

5.13.1.2 Lubrication points

The lubricating oil is applied by means of a lubricating brush (Image 55 / pos. 2 + Image 56 / pos. 6). The following lubrication points are supplied with lubricating oil:

- Roller chains of the conveyor unit drive (Image 55 / pos. 1)
- Roller chains of the pick-up drive (Image 56 / pos. 5)

Conveyor unit drive	Pick-up drive
<p>Image 55: Conveyor unit drive</p>	<p>Image 56: Pick-up drive</p>

To ensure that the lubricating oil is correctly applied to the roller chains (Image 55 / pos. 1 + Image 56 / pos. 5), the lubricating brushes (Image 55 / pos. 2 + Image 56 / pos. 6) must be mounted in the correct position. They should touch the roller chains (Image 55 / pos. 1 + Image 56 / pos. 5) lightly. If the lubricating brushes (Image 55 / pos. 2 + Image 56 / pos. 6) rub too hard, they will wear quickly. Replace severely worn lubricating brushes (Image 55 / pos. 2 + Image 56 / pos. 6) immediately.



Observe also the notes and instructions in the operating instructions, chapter “Care and maintenance”, section “Lubrication”.

5.13.2 Central lubrication system

An automatic central lubrication system (Image 57 / pos. 1) is optionally available. This automatically supplies all fixed lubrication points as well as the roller chains (if fitted) with grease during operation.



Observe also the notes and instructions in the manufacturer's operating instructions for the supplied lubrication system.

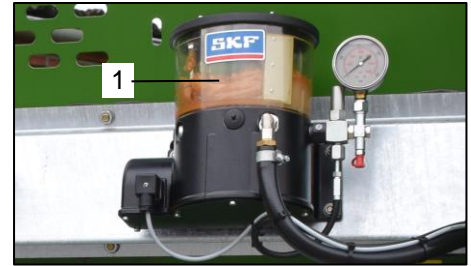

Image 57: Lubrication system

	WARNING!
	<p>Danger through system pressure / hydraulic pressure. Lubrication systems are under high pressure during operation.</p> <ul style="list-style-type: none"> • Before starting installation, maintenance or repair work and before making modifications or repairs on the vehicle, lubrication systems must be depressurized.

	NOTE
	<p>The lubrication system works automatically. A visual check of the lubricant flow in the lubrication lines should nevertheless be performed regularly.</p> <ul style="list-style-type: none"> • Check all lubrication points for sufficient grease supply every day! • Top up grease at the lubricating nipples of the drive shafts and other lubrication points on rotating components according to the lubrication schedule.

5.13.2.1 Lubrication pump

The lubrication pump (Image 58 + Image 59 / pos. 1) pumps the lubricant from the lubricant reservoir (Image 58 + Image 59 / pos. 2) to the downstream lubrication points or manifolds at a defined flow rate.

The lubricant reservoir (Image 58 + Image 59 / pos. 2) is made of transparent plastic and has fill level marks that allow a visual fill level check.

During operation, the stirrer blades in the lubricant reservoir (Image 58 + Image 59 / pos. 2) must rotate.

Pump without controller	Pump with controller
Image 58: Pump without controller	Image 59: Pump with controller

The operating pressure is indicated on the pressure gauge (Image 58 + Image 59 / pos. 3).

Operating pressure when pump is running:	10 – 280 bars
Pressure less than 10 bars:	<ul style="list-style-type: none">• Fill the pump.• Vent the pump.
Pressure over 280 bars:	<ul style="list-style-type: none">• Eliminate system blockage.



Observe also the notes and instructions in the operating instructions, chapter “Care and maintenance”, section “Lubrication”.

5.14 Drive

The vehicle's drive system consists of several separate drives, which are described in the following sections. This is illustrated in the following section "Driveline layout".

Main drive

The vehicle's main drive is powered by the tractor's PTO shaft. This supplies the drives of the conveyor unit, the pick-up and the dosing unit (depending on the equipment of the vehicle).

Pick-up drive

The pick-up's drive is powered by the tractor's PTO shaft. The cam clutch at the PTO cardan shaft to the tractor protects the drive from excessive forces. The pick-up is driven with a strong roller chain.

Conveyor unit drive

The conveyor unit is driven mechanically via the tractor's PTO shaft. The cam clutch at the PTO cardan shaft to the tractor protects the drive from excessive forces. The rotors are driven with a strong roller chain.

Scraper floor drive

The scraper floor is driven hydraulically through the tractor hydraulics. A hydraulic motor is driven by the controlled oil flow from the tractor and transmits its rotary motion to the feed shaft at the rear of the vehicle via a gearbox.

Dosing unit drive (depending on the vehicle's equipment)

The dosing unit is driven by the PTO shaft of the tractor and can be connected via dog clutch. The cam clutch in the PTO cardan shaft protects the drive from excessive forces. The dosing rollers are driven via a gearbox and roller chains.

Cross conveyor belt drive (depending on the vehicle's equipment)

The cross conveyor belt is driven hydraulically through the tractor hydraulics. A hydraulic motor is driven by the oil flow from the tractor and transmits its rotary motion to the drive shaft of the cross conveyor belt.

5.14.1 Drive shaft

	WARNING!
	<p>Failure to observe the safety instructions may result in serious injury or death.</p> <ul style="list-style-type: none"> • In order to prevent accidents, the operator of the vehicle must read and observe the safety instructions in the “Safety” chapter.

	WARNING!
	<p>Danger of trapping and entanglement for people can arise when the drive shaft guards are incomplete or damaged!</p> <ul style="list-style-type: none"> • Never use the drive shaft without guard, with a damaged guard or without correct use of the safety chain. Immediately have any damaged or missing parts of the drive shaft replaced by original parts from the drive shaft manufacturer. • The unprotected parts of the drive shaft must always be protected by a guard shield on the tractor and a guard cup on the vehicle. • Before each use, check whether all drive shaft guards are fitted and working properly. • Before taking the vehicle into operation, make sure that the drive shaft in combination with the PTO guard shield on the tractor and the vehicle-side guard cup have sufficient free space in all operating states (e.g. driving round curves and over uneven ground). Contact of the drive shaft with the tractor or vehicle causes damage to the drive shaft.

	NOTE
	<p>Always observe the following points:</p> <ul style="list-style-type: none"> • Correct use and maintenance of the drive shaft helps prevent serious accidents. • Make sure that the drive shaft connections are firmly engaged. Before each use and at regular intervals, check the connections for tightness. Retighten screwed and bolted connections after the first 5 operating hours. • On drive shafts between tractor and vehicle, overload and overrunning clutches must always be installed on the vehicle side. • Make sure that the sliding sections have the specified overlap in both the working and the driving position. • Observe the vehicle’s specified drive speed. • Place the uncoupled drive shaft only in the provided mount. • On attached and semi-mounted vehicles, secure towing couplings, lower links, supports, etc. in a suitable position to prevent damage to the drive shaft guard.



Observe also the notes and instructions in the drive shaft manufacturer’s operating instructions.

5.14.1.1 Adapting the drive shaft

The length of the drive shaft must be adapted to the tractor used when taking the vehicle into operation for the first time. Whenever you change the tractor, you must also adapt the shaft again.



Observe also the notes and instructions in the operating instructions in chapter “Commissioning”, section “Adapting to the tractor” / “Adapting the drive shaft”.

5.14.1.2 Drive shaft coupling and connection

This section describes the procedure for installing and removing different types of drive shaft couplings:



Observe also the notes and instructions in the operating instructions, chapter "Functions and settings", section "Drive shaft" / "Installing the drive shaft" and "Removing the drive shaft".

Push-pin coupling:

Installation:

- Press the sliding pin (Image 60 / pos. 1) and slide the drive shaft onto the PTO shaft until the sliding pin engages in the radial groove.

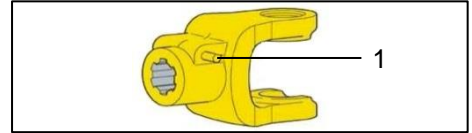

Removal:

- Press the sliding pin (Image 60 / pos. 1) and pull the drive shaft off the PTO shaft.

Image 60: Push-pin coupling

QS slide collar coupling:

Installation:

- Pull back the slide collar (Image 61 / pos. 2) until it remains in its opened position and push the drive shaft onto the PTO shaft until the coupling lock engages.

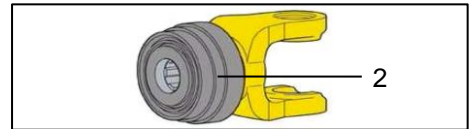

Removal:

- Pull back the slide collar (Image 61 / pos. 2) and pull the drive shaft off the PTO shaft.

Image 61: QS slide collar coupling

AS slide collar coupling:

Installation:

- Pull back the slide collar (Image 62 / pos. 3) and push the drive shaft onto the PTO shaft until the coupling lock engages.

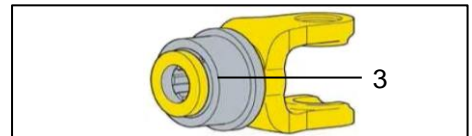

Removal:

- Pull back the slide collar (Image 62 / pos. 3) and pull the drive shaft off the PTO shaft.

Image 62: AS slide collar coupling

Quick coupling:

Installation:

- Pull back the slide collar (Image 63 / pos. 4) and push the drive shaft onto the PTO shaft until the lock engages.

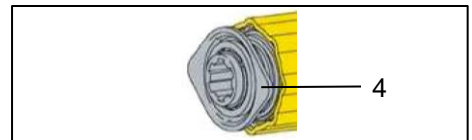

Removal:

- Pull back the slide collar (Image 63 / pos. 4) and pull the drive shaft off the PTO shaft.

Image 63: Quick coupling

Conical clamp screw coupling:

Installation:

- Unscrew the conical clamp screw (Image 64 / pos. 5). Push the drive shaft on until the hole in the yoke or coupling is aligned with the radial groove.
- Screw in the conical clamp screw and tighten to a torque of 100 Nm.

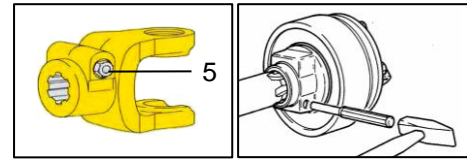

Image 64: Conical clamp screw coupling

Removal:

- Unscrew the conical clamp screw (Image 64 / pos. 5). If this is not possible by hand, you can also knock out the conical clamp screw from the other side (Image 64).
- Then pull the drive shaft off the PTO shaft.

Clamp screw coupling:

Installation:

- Extract clamp screw (Image 65 / pos. 6). Push the drive shaft on until the hole in the yoke is aligned with the radial groove.
- Fit and tighten the clamp screw(s).
Tightening torque: M12 = 80 Nm
M14 = 130 Nm
M16 = 200 Nm

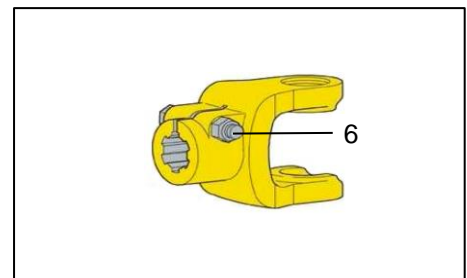

Image 65: Clamp screw coupling

Removal:

- Unscrew the conical clamp screw (Image 65 / pos. 6). If this is not possible by hand, you can also knock out the conical clamp screw from the other side (Image 65).
- Then pull the drive shaft off the PTO shaft.

Tube clamp coupling:

Installation:

- Release both screws and remove the tube clamp (Image 66 / pos. 7).
- Push the drive shaft on until the hole in the yoke is aligned with the radial groove.
- Align the drive shaft with the tractor's PTO shaft and support it such that it cannot get wedged when fitting the tube clamp.
- Fit the tube clamp jaws with screws. Tighten the screws alternately.
Tightening torque: M16 = 150 Nm

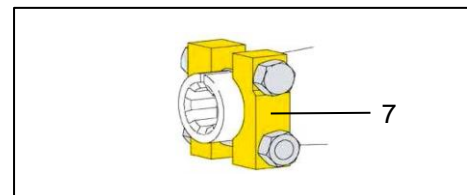



Image 66: Tube clamp coupling

Removal:



- Remove the tube clamp (Image 66 / pos. 7).
- Then pull the drive shaft off the PTO shaft.

5.14.1.3 Installing the drive shaft

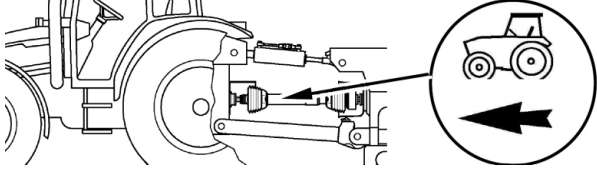
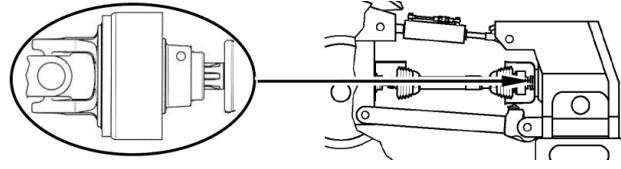
	<p>WARNING!</p>
<p>Risk of injury through movements of tractor and vehicle or of vehicle parts!</p> <ul style="list-style-type: none"> Before performing any work on the vehicle, secure the tractor and the vehicle against unintentional rolling and starting! Keep people out of the tractor and vehicle danger areas and away from moving vehicle parts! <p>  Observe the notes and instructions in the operating instructions, chapter "Commissioning", section "Securing the vehicle against unintentional rolling and starting". </p>	

Tractor	Vehicle
	
Image 67: Drive shaft tractor side	Image 68: Drive shaft vehicle side
The tractor symbol on the drive shaft guard tube indicates the tractor-side connection of the drive shaft.	Overload clutches and overrunning clutches must always be fitted on the vehicle side.

Connect the drive shaft as follows:

- Correctly couple the vehicle to the tractor.
 -  Observe the notes and instructions in the operating instructions, chapter "Commissioning", section "Coupling to the tractor".
- Secure the vehicle against rolling and unintentional starting.
 -  Observe the notes and instructions in the operating instructions, chapter "Commissioning", section "Securing the vehicle against unintentional rolling and starting".
- Clean and grease the PTO shaft on the tractor and on the vehicle.
- Before use, check the length of the drive shaft in all operating conditions to prevent compression and insufficient sliding section overlap.
- Release and pull back the drive shaft guard cone.
- Fit the drive shaft, observing the mounting direction (Image 67 & Image 68) and the mounting instructions for the respective connection / coupling type.
 -  Observe the notes and instructions in the operating instructions, chapter "Functions and settings", section "Drive shaft" "Drive shaft coupling and connection".
- Refit the drive shaft guard cone properly.
- Engage the drive shaft safety chain (Image 69 / pos. 1) such that the drive shaft can swivel sufficiently in all directions in all operating states. Fit as near as possible at right angles to the drive shaft.
- Make sure that the safety chain cannot catch on components of the tractor or vehicle.

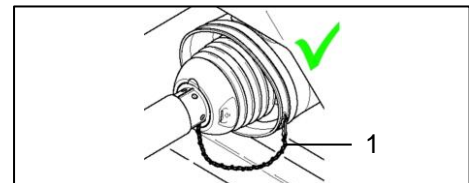







Image 69: Safety chain

5.14.1.4 Removing the drive shaft

	WARNING!
	<p>Risk of injury through movements of tractor and vehicle or of vehicle parts!</p> <ul style="list-style-type: none"> • Before performing any work on the vehicle, secure the tractor and the vehicle against unintentional rolling and starting! • Keep people out of the tractor and vehicle danger areas and away from moving vehicle parts! <p>  Observe the notes and instructions in the operating instructions, chapter "Commissioning", section "Securing the vehicle against unintentional rolling and starting". </p>

	CAUTION!
	<p>Danger of burns on contact with hot components of the drive shaft!</p> <ul style="list-style-type: none"> • Do not touch hot components of the drive shaft, in particular clutches.

Disconnect the drive shaft as follows:

- Correctly uncouple the vehicle from the tractor.
 - 
 Observe the notes and instructions in the operating instructions, chapter "Commissioning", section "Uncoupling from the tractor".
- Secure the vehicle against rolling and unintentional starting.
 - 
 Observe the notes and instructions in the operating instructions, chapter "Commissioning", section "Securing the vehicle against unintentional rolling and starting".
- Pull the drive shaft off the tractor's PTO shaft, observing the connection instructions for the respective connection / coupling type.
 - 
 Observe the notes and instructions in the operating instructions, chapter "Functions and settings", section "Drive shaft" "Drive shaft coupling and connection".
- Set down the drive shaft correctly as described below.

Top coupling

- When parking the vehicle, secure the drive shaft with the chain. The drive shaft must be held in the front third of its length (Image 70).
- The safety chain on the drive shaft prevents the guard from turning out of position and must not be used for suspending the drive shaft!



Image 70: Top coupling

Bottom coupling

- When parking the vehicle, set down the drive shaft correctly. The drive shaft must be held in the front third of its length (Image 71).



Image 71: Bottom coupling

- Before an extended standstill, clean and lubricate the drive shaft.



Observe the notes and instructions in the operating instructions, chapter "Care and maintenance", section "Drive" / "Drive shaft".

5.14.1.5 Drive shafts with overload clutch or overrunning clutch

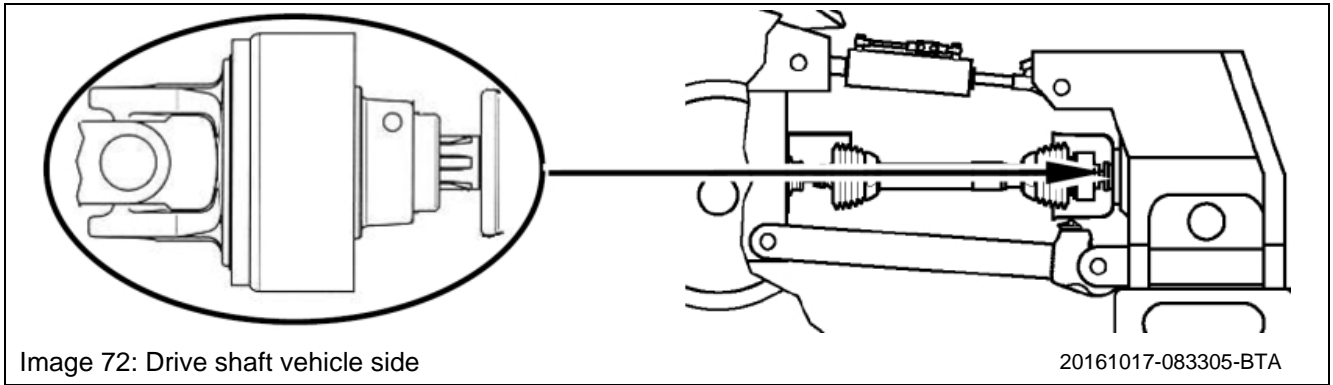



Image 72: Drive shaft vehicle side

20161017-083305-BTA

	NOTE
	<p>Overload clutches and overrunning clutches must always be fitted on the vehicle side.</p>

Radial pin clutch

Interrupting power transmission when the set torque is exceeded.

- When the radial pin clutch slips (ratchet sound), immediately stop the PTO.

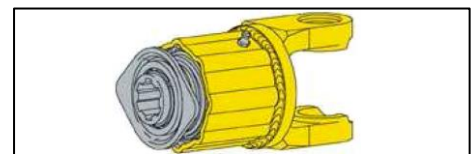

Image 73: Radial pin clutch

Shear bolt coupling

An overload will break the shear bolt (Image 74 / pos. 20) and interrupt the power transmission.

- Replace shear bolts only with shear bolts of the same dimensions (observe the threaded length) and strength class.

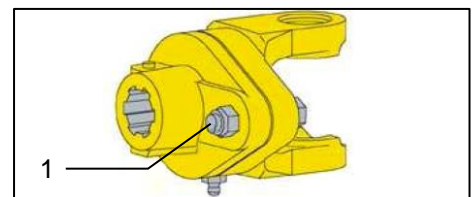

Image 74: Shear bolt coupling

Cam clutch / key type clutch

If the set torque is exceeded because of an overload, the power transmission is interrupted.

- Automatic restarting (torque build-up) through switching off the PTO.

Attention: Restarting is also possible by lowering the PTO speed.

- Avoid switch-off times of more than 10 seconds!
At 1000 rpm, the clutch or vehicle can become damaged!

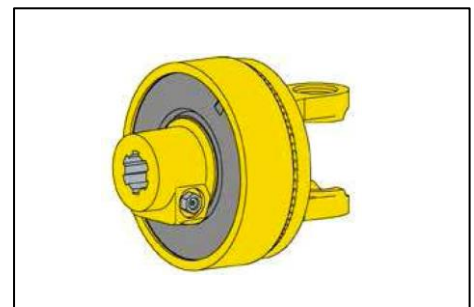

Image 75: Cam clutch / key type clutch

Friction clutch

In cases of overload and intermittent torque peaks, the torque is limited and evenly transmitted during the slip time.

- To ensure their correct function, friction clutches must be disengaged before their first use and after a longer standstill. To do this, release the friction linings and turn the clutch by hand.



Observe also the notes and instructions in the operating instructions, chapter "Care and maintenance", section "Drive" / "Drive shaft".

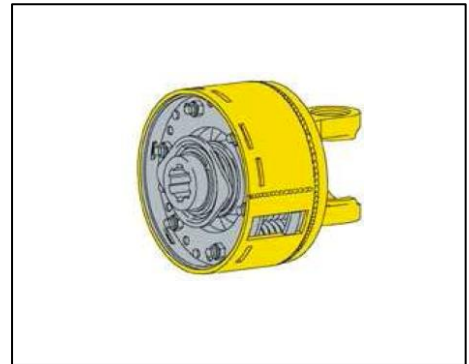

Image 76: Friction clutch

Overrunning clutch

Protects the drive from vehicle components that continue to run on when the drive stops (e.g. when the PTO is switched off).

- Enter the vehicle area only when the rotating parts have come to a complete standstill!

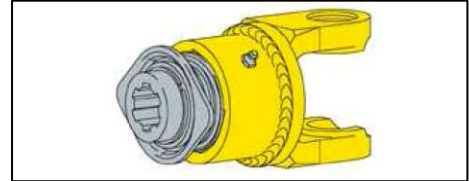

Image 77: Overrunning clutch

Friction overrunning clutch

Friction overrunning clutches are a combination of friction clutch and overrunning clutch.

- Enter the vehicle area only when the rotating parts have come to a complete standstill!

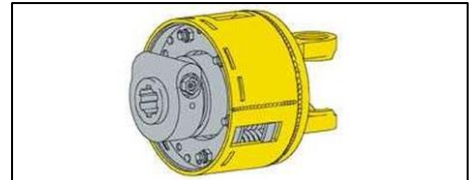





Image 78: Friction overrunning clutch

5.15 Hydraulics

	WARNING!
	<p>Danger caused by not observing basic safety instructions.</p> <p>This can cause serious injuries.</p> <div style="display: flex; align-items: center;">  <p>For this, it is essential to observe the safety instructions in the "Safety" chapter in the "General Safety Instructions" section, in particular the "Hydraulic System" section.</p> </div>

	WARNING!
	<p>There is danger of infections and serious injuries to persons can occur when hydraulic oil escapes under high pressure and penetrates into the body!</p> <ul style="list-style-type: none"> When coupling and uncoupling the hydraulic supply lines, ensure that the hydraulic system is pressureless on both the vehicle and the tractor side. The tractor control units must always be set in the floating position before coupling. To prevent personal injury, always use appropriate equipment and wear protective goggles when looking for leaks. In case of injury, notify a doctor immediately. There is a risk of infection. Regularly inspect hoses and replace them with original BERGMANN hoses if old or damaged.



For this, also observe the instructions and notices in the operating instructions from the tractor manufacturer!

5.15.1 Storing the Supply Lines

Disconnected hydraulic system supply lines (as well as brake system supply lines, power cables) must be mounted on the supply line rack (Image 79 / Pos.1) in the corresponding park position at the front of the machine.



Image 79: Rack

5.15.2 Hydraulic Supply Line Markings



WARNING!

Danger due to incorrect supply line connection

Incorrect connection of the supply lines can lead to considerable hazards for persons due to machine malfunctions.

- When coupling the hydraulic lines, always check for correct connection.

The hydraulic supply lines for the individual vehicle hydraulic functions are marked with color codes and corresponding function symbols.



NOTICE

- If coupling markings are missing, check the hydraulic line function prior to coupling.
- Replace the missing markings immediately! Assembly instructions can be found in the following Image 80 section.

Supply lines

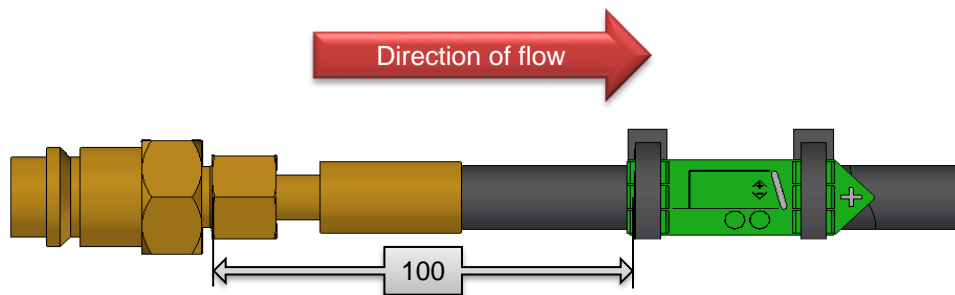

Return lines

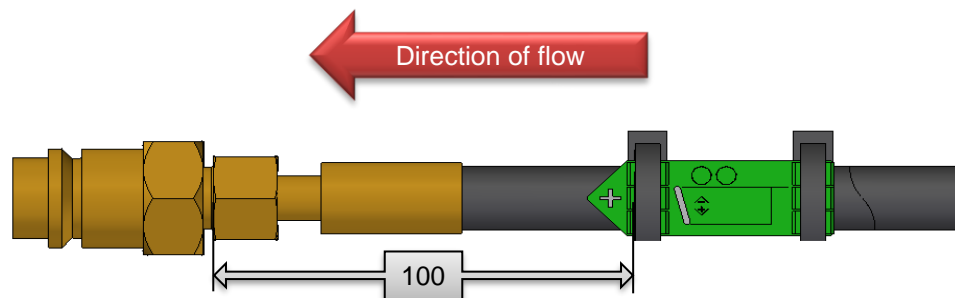



Image 80: Position of markings



The possible connection lines and the corresponding color markings with function symbols (depending on vehicle equipment) can be seen in the following "Hydraulic Systems" sections.

5.15.3 Hydraulic System “E-Control”

The vehicle can be equipped with an "E-control" hydraulic system depending on the vehicle type and equipment. This is a circulating hydraulic system with an electro-hydraulic control block. After coupling the supply lines to the tractor, the vehicle hydraulic functions can be actuated directly from the terminal.

	NOTICE
	The maximum allowable system pressure is 210 bars.

5.15.3.1 Control block

If the machine is equipped with an electro-hydraulic control block, pressurized oil must be fed into the hydraulic system at all times during the vehicle operation. The operating speed depends on the tractor hydraulic system. Depending on the type of tractor, it may be necessary to correct the operating speed on the tractor control unit.

The vehicle functions which can be actuated by the control block are shown in the following section. The figure below shows a fully equipped control block. Actual vehicle equipment may differ.

5.15.3.1.1 Control block emergency operation

	WARNING!
	<p>Danger due to moving components during emergency actuation!</p> <ul style="list-style-type: none"> • Ensure third persons leave the vehicle danger area before using the emergency control on the control block.

	NOTICE
	In case of a power failure, check the fuses in the tractor and control unit (supply line). Check cables and connections.

Electrically controlled hydraulic valves which are used for "Emergency control" can be controlled manually. The valves can be controlled using a pointy object.

The diagram below shows a fully equipped control block. When the vehicle has less equipment, the valve order advances. In this case the assignment of the valves for each function corresponds to the cable marking, or by tracking the hydraulic lines.

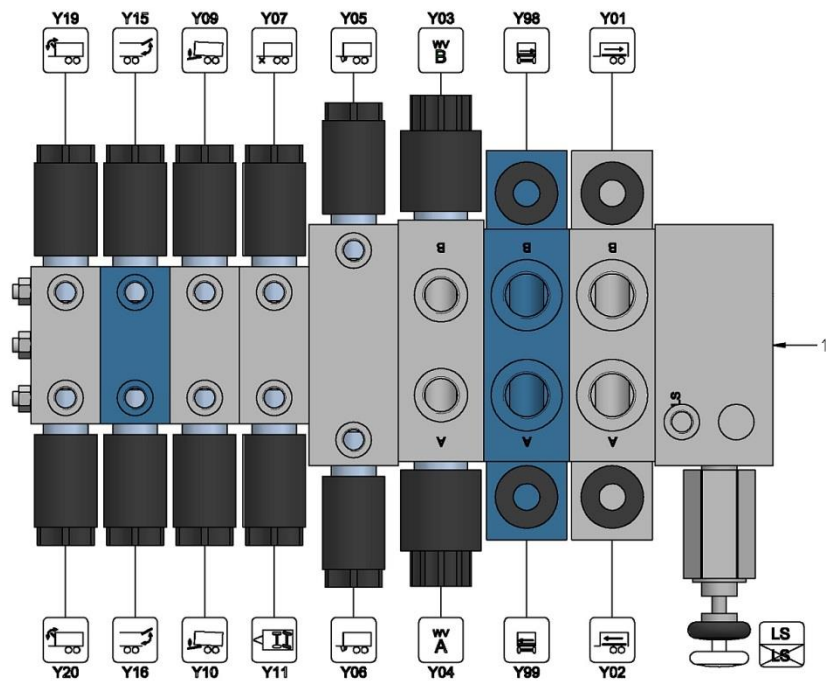

Image 81: Control block

B09-1985-PLN_20180613-BTA

		Y 01	Y 02	Y 03	Y 04	Y 05	Y 06	Y 07	Y 09	Y 10	Y 11	Y 15	Y 16	Y 19	Y 20	Y 98	Y 99
Drawbar	↑			X					X	X							
	↓				X				X	X							
Front wall	↑			X										X	X		
	↓				X									X	X		
Pick-up	↑			X				X									
	↓							X									
Cutting unit	↑			X		X	X										
	↓				X	X	X										
Scraper floor	→	X															
	←		X														
Steering axle	↑										X						
	↓				X						X						
Tailgate	↑			X								X	X				
	↓				X							X	X				
Cross conveyor belt	→															X	
	←																X

5.15.3.2 Hydraulic System Supply Line "E-Control"

In the following list, the hydraulic supply lines which can be used with the types of vehicles are listed with the respective hydraulic system "E-control" markings. The hydraulic supply lines can vary depending on vehicle equipment.



For this, observe the notices and instructions in the operating instructions in chapter "Functions and Settings" in the Hydraulics" and the "Hydraulic Supply Line Markings" sections.

Supply lines for the control block:

The control block hydraulic supply lines must be connected to the appropriate tractor connections depending on the supply system settings.

Which control block hydraulic supply lines must be coupled with the appropriate tractor connections depends on the respective supply system and the associated control block hand wheel adjustment.



For this, observe the operating instructions and other instructions in the operating instructions in the chapter "Hydraulics" and the "Supply System for E-control" section!

5.15.3.3 Supply System with "E-control"

The tractor hydraulic system can vary depending on type and equipment, and determines the power system settings for the coupled vehicle. The change between the different supply systems is done without tools by simply turning the hand wheel on the control block on or off (Image 82 / Pos. 1).

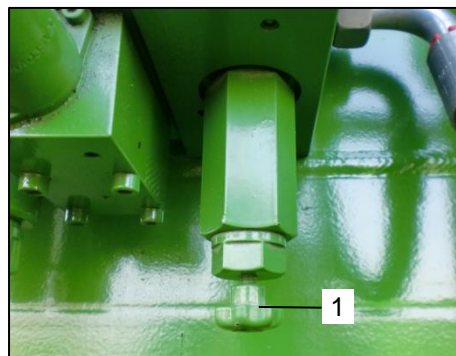

Image 82: knob

The control block hydraulic supply lines must be connected to the appropriate tractor connections depending on the supply system settings.

The following sections show the different supply systems and the required hydraulic supply lines and settings.

Supply system with constant volume flow (OC)

The oil is pumped from the pump through the tractor valve to the pulled vehicle. It flows according to the volume flow setting on the tractor valve. If the vehicle does not need oil, it flows to the tank via the 3-way pressure compensator. If oil is directed to consumers via directional control valve, only the residual flow flows to the tank through pressure compensator.

If a tractor with load sensing hydraulics is used and the pulled vehicle is supplied via the tractor valve, this is a constant delivery pumping system.

With such a system, the handwheel must be turned out to the stop.

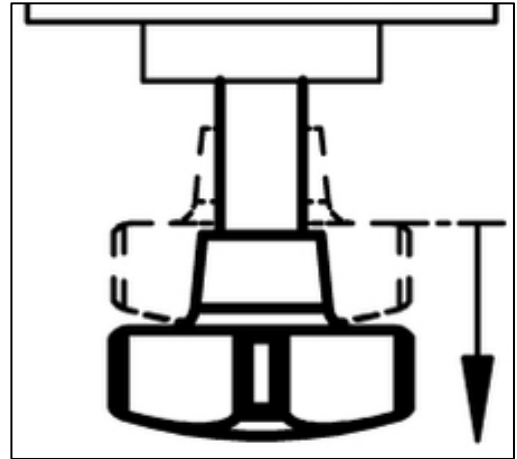



Image 83: Hand wheel turned out

Attach the following hydraulic supply lines from the control block to the appropriate connections on the tractor in the following sequence:

	Return (tank)	18-13-0210
	Hose:	22L
	Tractor connection:	1 free return line
Colour:		Red
Always connect the "return" line to the appropriate tractor connection first!		

	Power	18-13-0209
	Hose:	18L
	Tractor connection:	1 single action control unit
Colour:		Red

Supply system with constant system pressure

Constant pressure systems are still found in some older tractors. In such systems, the tractor pump always tries to maintain the maximum pressure. If the consumers do not need oil, the pump does not supply any oil. Since the pump always provides the maximum pressure, pressure drops (Δp) must be limited by the pressure compensator in the inlet plate.

With such a system, the hand wheel must be turned in to the stop.

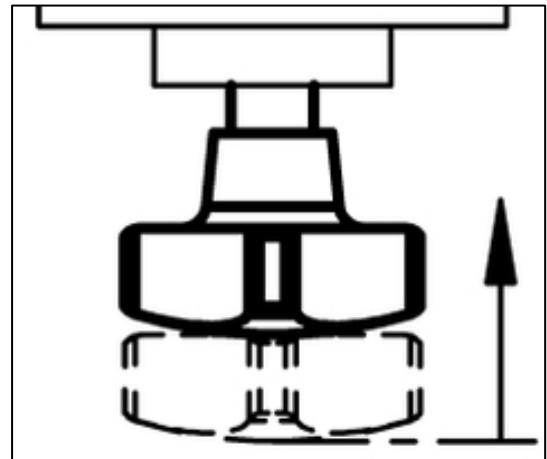



Image 84: Hand wheel in

Attach the following hydraulic supply lines from the control block to the appropriate connections on the tractor in the following sequence:

	Return (tank)	18-13-0210
	Hose:	22L
	Tractor connection:	1 free return line
Colour:		Red
Always connect the "return" line to the appropriate tractor connection first!		

	Power	18-13-0209
	Hose:	18L
	Tractor connection:	1 single action control unit
Colour:		Red

Supply system, load sensing (CC)

The control block input plate is equipped with a relief controller. 0.7 l/min flow through it and into the tank. Load sensing ensures that the pump is reset as soon as a consumer is switched off. If the pulled vehicle is to be connected to a load sensing system, it must be supplied via "Power Beyond". The pressure compensator in the control block is blocked and as a result no oil flows from the pressure connection (P) to the tank. The load sensing pump continues to pump oil until the set pressure drop (Δp) between pressure connection (P) and load sensing line is reached. If consumers require oil, the load sensing pump supplies oil until the pressure drop (Δp) is reached again. There is no residual flow which must be directed to the tank.

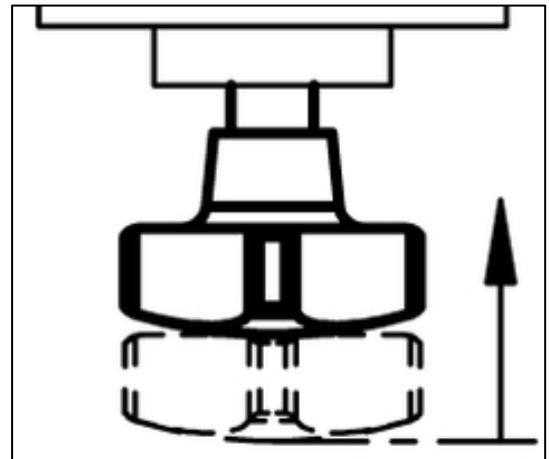





Image 85: Hand wheel in

Pressure drops and fluctuations in tractor hydraulics have an effect on the volume flows to the consumers. Some tractors are also equipped with load sensing relief. This can lead to supply shortages to the consumers. In this case load sensing on the tractor must be closed.

Attach the following hydraulic supply lines from the control block to the appropriate connections on the tractor in the following sequence:

	Return (tank) 18-13-0210
	Hose: 22L Tractor connection: 1 free return line Colour: Red
Always connect the "return" line to the appropriate tractor connection first!	

	Flow (power) 18-13-0209
	Hose: 18 l Tractor connection: 1 pressure connection (flow) Colour: Red

	Load sensing (LS) 18-13-0211
	Hose: 12L Tractor connection: 1 LS Connection Colour: Red

5.15.3.4 Coupling the hydraulic supply lines with “E-control”

	NOTICE
	<p>Ensure that:</p> <ul style="list-style-type: none"> • When coupling and uncoupling the hydraulic supply lines the hydraulic system is pressureless on both the vehicle and the tractor side. The tractor control units must always be set in the floating position before coupling. • No hydraulic oil escapes into the environment while the hydraulic supply lines are being coupled. • That the hydraulic plugs are pushed into the socket until they audibly engage and lock. • That hydraulic lines do not rub on foreign objects during vehicle movements (e.g. in curves), lines should not be tensioned, kinked or rubbed.

When coupling proceed as follows:

- Move the relevant adjustment element on the tractor to the float position.
- Secure the tractor and vehicle against unintentional rolling and starting.
- Clean the plugs and the sleeves before coupling the elements to prevent malfunctions in the hydraulic system.
- Adjust the control block hand wheel according to the respective supply system.



For this, observe the notices and instructions in the operating instructions in chapter "Functions and Settings" in the Hydraulics" / "Hydraulic Supply System with E-control" sections.

- Couple the hydraulic supply lines from the control block on the respective supply system to the appropriate tractor connections.



For this, observe the notices and instructions in the operating instructions in chapter "Functions and Settings" in the Hydraulics" / "Hydraulic Supply System with E-control" sections.



Which tractor connections are needed can be found in the operating instructions in chapter "Functions and Settings" in the Hydraulics" / "Hydraulic Supply System with E-control" sections.

- Connect the required hydraulic supply lines for additional functions without control block connection to the appropriate tractor control units for the functions to be carried out.



Which tractor connections are needed can be found in the operating instructions in chapter "Functions and Settings" in the Hydraulics" / "Hydraulic Supply System with E-control" sections.

5.15.3.5 Uncoupling the hydraulic supply lines with "E-control"

**NOTICE**

Ensure that:

- When uncoupling the hydraulic supply lines the hydraulic system is without pressure on both the vehicle and the tractor side. The tractor control units must always be set in the floating position before coupling.

When uncoupling proceed as follows:

- Move the relevant adjustment element on the tractor to the float position.
- Secure the tractor and vehicle against unintentional rolling and starting.
- First, uncouple the hydraulic connectors of the supply lines from the tractor's hydraulic sockets. Then uncouple the return and tank lines from the tractor's hydraulic sockets.
- Protect the hydraulic plugs and sleeves from dirt using dust caps.
- Place the hydraulic supply lines in their respective positions in the supply line rack.



For this, observe the notices and instructions in the operating instructions in chapter "Functions and settings" in the Hydraulics" and the "Storing the hydraulic supply lines" sections.

5.16 Terminal

Depending on its type and equipment, the vehicle can be fitted and operated with various terminals.



Observe the notes and instructions in the operating instructions, chapter "Operation".

5.17 Brake system



DANGER!

Risk of death if brakes are defective!

These dangers can cause severe and potentially fatal injuries.

- Check the brakes before every use.
- A thorough brake system inspection is to be conducted on a regular basis.
- Adjustment and repair work on the brakes must only be carried out by qualified specialists.



WARNING!

Danger through non-observation of the basic safety instructions.

This can cause serious injuries.



When doing this, always observe the safety instructions in the operating instructions, chapter "Safety", section "Basic safety instructions", in particular section "Brake system".



NOTE

The drum brake linings require a few hours of operation to adapt to the drum brake. and achieve their full braking performance.

- Test the function of the brake system before using or towing the vehicle.

5.17.1 Parking brake with hand crank



WARNING!

Danger of unintentional rolling away of the vehicle!

If the parking brake is not engaged when parking the vehicle, the vehicle may unintentionally start to move. This can cause serious injuries or death.

- Always engage the parking brake when you leave the tractor or park the vehicle.
- Before performing any work on the vehicle, secure the tractor and the vehicle against unintentional rolling and starting!



Observe the notes and instructions in the operating instructions, chapter “Commissioning”, section “Securing the vehicle against unintentional rolling and starting”.

The engaged parking brake (Image 86 / pos. 1) prevents the vehicle from rolling away at its maximum permissible gross weight at an inclination of max. 18%.

To operate the parking brake (Image 86 / pos. 1), turn the hand crank (Image 86 / pos. 2), which operates the spindle (Image 86 / pos. 3) and steel cables (Image 86 / pos. 4).

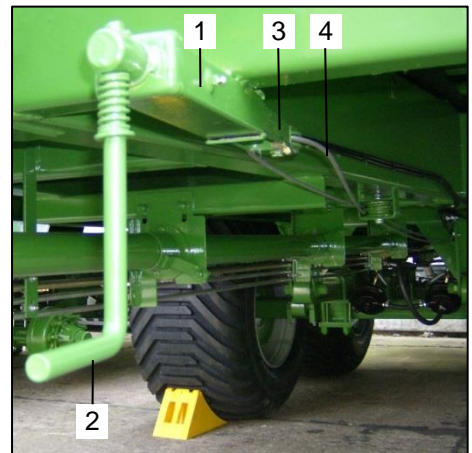

Image 86: Parking brake



NOTE

Make sure that the cable pull (Image 86 / pos. 4) does not rest or chafe on other vehicle parts. When the parking brake is fully released, the brake cable (Image 86 / pos. 4) should sag slightly.

5.17.1.1 Hand crank in rest position and in operating position

To move the hand crank (Image 87 + Image 88 / pos. 2) from its rest position into its operating position or vice versa, turn the handle through 180°.

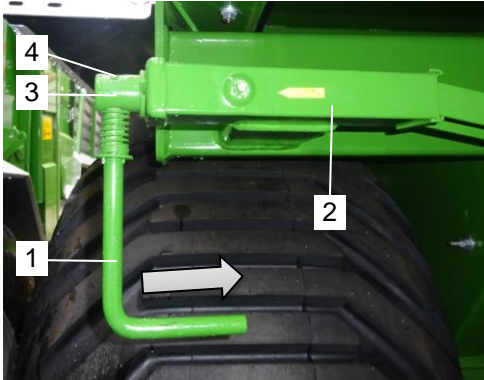
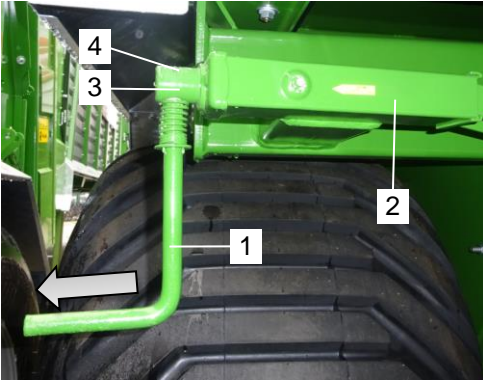
Rest position	Operating position
	
<p>Image 87: Hand crank in rest position</p>	<p>Image 88: Hand crank in operating position</p>
<p>Handle of hand crank points towards the parking brake.</p>	<p>Handle of hand crank points away from the parking brake.</p>

Pivot the hand crank (Image 87 + Image 88 / pos. 2) into its park or operating position as follows:

- Press the hand crank (Image 87 + Image 88 / pos. 2) towards the crank's pivot point (Image 87 + Image 88 / pos. 3) and move it into the desired position.
- After turning, make sure that the cotter pin (Image 87 + Image 88 / pos. 4) at the crank's pivot point (Image 87 + Image 88 / pos. 3) engages in the recess.

5.17.1.2 Releasing parking brake with hand crank

To release the parking brake, do the following:

- Move the hand crank (Image 87 / pos. 1) from its rest position into its operating position (Image 88 / pos. 1).
- Turn the hand crank (Image 88 / pos. 1) anticlockwise until the cable pull (Image 86 / pos. 4) is slack and the brake is released.
- Return the hand crank (Image 88 / pos. 1) from its operating position to its rest position (Image 87 / pos. 1).

5.17.1.3 Engaging parking brake with hand crank

To engage the parking brake, do the following:

- Move the hand crank (Image 87 / pos. 1) from its rest position into its operating position (Image 88 / pos. 1).
- Turn the hand crank (Image 88 / pos. 1) clockwise until the resistance noticeable increases and the brake is engaged through the cable pull (Image 86 / pos. 4).
- Return the hand crank (Image 88 / pos. 1) from its operating position to its rest position.

5.18 Electrical system

**WARNING!****Danger through non-observation of the basic safety instructions.**

This can cause serious injuries.



Always observe the safety instructions in the operating instructions, chapter "Safety", section "Basic safety instructions", in particular section "Electrical system".



Observe also the notes and instructions in the tractor manufacturer's operating instructions.



The connection diagrams are included in the operating instructions, chapter "Care and maintenance", section "Connection diagram" / "Electrical system".

The following sections include detailed information about the electronic components of your vehicle.

The components and vehicle functions listed in the operating instructions may differ from the series vehicle and are available as optional features in some cases. Since these operating instructions are general, various equipment options can be listed that are not available for your vehicle.

5.18.1 Operation



Observe the notes and instructions in the operating instructions in the separate chapter "Operation".

5.18.2 Setting sensors

The sensors are optimally set and positioned on delivery of the vehicle. Should setting be necessary, observe the following sections.



Adjusting the sensor positions depends on the respective vehicle function. Observe also the instructions and notes in the following sections for the sensors for each vehicle function.

5.18.2.1 Inductive sensor “Opener” & “Closer”

Pos.1: Inductive sensor “Opener” & “Closer”

- Opener: Sensor switches if there is no overlap with the signal transmitter, PIN 1 and PIN 2 are connected.
- Closer: Sensor switches if there is an overlap with the signal transmitter, PIN 1 and PIN 2 are connected.

Pos.2: Nuts (2 pcs)

- For fastening the sensors.

Pos.3: Signal transmitter

- Moving component (e.g. tailgate)

Pos.4: Sensor mount

- Fixed component (e.g. mount)

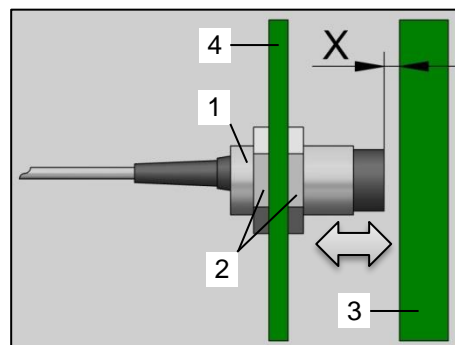

Image 89: Opener & closer

Sensor data:

Thread:	M18
Maximum tightening torque:	25 Nm
Connections:	PIN 1 = -
	PIN 2 = + (12 Volt)
	PIN 3 = Signal

Preparation:

- Move the adjustment element with the signal transmitter (Image 89 / Pos.3) that the sensor (Image 89 / Pos.1) is overlapped.



Setting:

Clearance:

X = 2 - 4 mm

- Loosen both nuts (Image 89 / Pos.2) on the sensor (Image 89 / Pos.1).
- Rotate the nuts (Image 89 / Pos.2), until distance X between the sensor and the signal transmitter is reached.
- Retighten both nuts (Image 89 / Pos.2) considering the maximum tightening torque.

5.18.3 Lower cutting unit sensor (left)

Pos. 1:	Lower cutting unit sensor (left)
Function:	Setting the disengagement travel of the cutting unit frame.
Version:	Inductive sensor "NC contact"
LED on:	 Cutting unit frame is fully disengaged up to the set point.
LED off:	 During disengagement, the cutting unit frame is still within the set area. Further disengagement is possible.

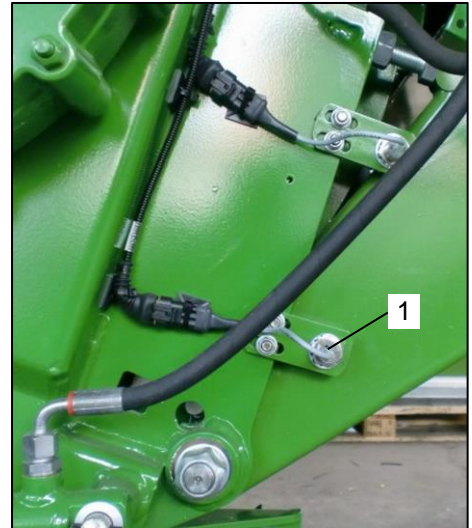

Image 90: Lower cutting unit sensor

Description:

When lowering, the cutting unit (Image 91 / pos. 1) disengages to the point that the knives remain in the cutting groove by a small amount and are guided through the cutting tub. The disengagement travel can be set by adjusting the lower sensor (Image 91 / pos. 2) on the cutting unit (Image 91 / pos. 1).

Setting:

Set the sensor (Image 91 / pos. 2) as follows:

- Disengage the cutting unit (Image 91 / pos. 1) until the knives still protrude into the conveying channel by about 10 mm.
- Release the nuts on the sensor bracket (Image 91 / pos. 3).
- Move the sensor (Image 91 / pos. 2), until the sensor's LED (Image 91 / pos. 2) goes out.
- Hold the sensor (Image 91 / pos. 2) in this position and retighten the nuts (Image 91 / pos. 3).

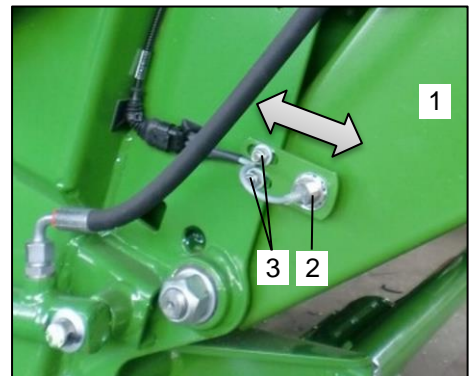



Image 91: Setting sensors



To adjust the distance between sensor and signaller, observe the notes and follow the instructions in the operating instructions, chapter "Functions and settings", section "Electrical system" / "Setting sensors".

5.18.4 Upper cutting unit sensor (left)

Pos. 1:	Upper cutting unit sensor (left)
Function:	Checking with the cutting unit frame not fully engaged.
Version:	Inductive sensor "NC contact"
LED on:	 The cutting unit frame is not yet fully engaged. This is indicated on the terminal.
LED off:	 Cutting unit frame fully engaged

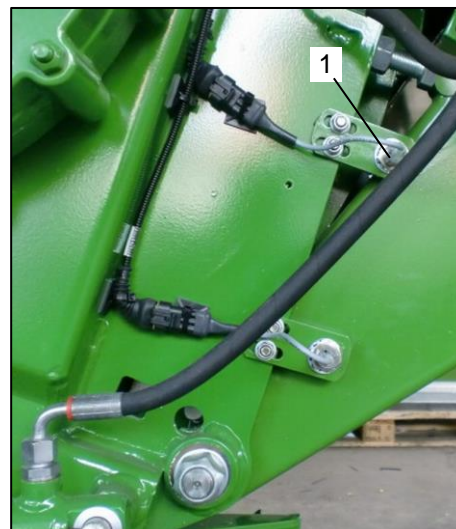

Image 92: Upper cutting unit sensor

Description:

The cutting unit (Image 93 / pos. 1) is equipped with a monitor. If the cutting unit frame (Image 93 / pos. 1) is not fully engaged and therefore still does not yet rest against the adjustment screws (Image 93 / pos. 4), the sensor (Image 93 / pos. 2) switches. The LED on the sensor (Image 93 / pos. 2) is lit and the terminal display signals the disengaged cutting unit (Image 93 / pos. 2).

Setting:

Set the sensor (Image 93 / pos. 2) as follows:

- Fully engage the cutting unit (Image 93 / pos. 1). It now rests against the adjustment screws (Image 93 / pos. 4).
- Release the nuts on the sensor bracket (Image 93 / pos. 3).
- Move the sensor (Image 93 / pos. 2), until the sensor's LED (Image 93 / pos. 2) goes out.
- Hold the sensor (Image 93 / pos. 2) in this position and retighten the nut (Image 93 / pos. 3).

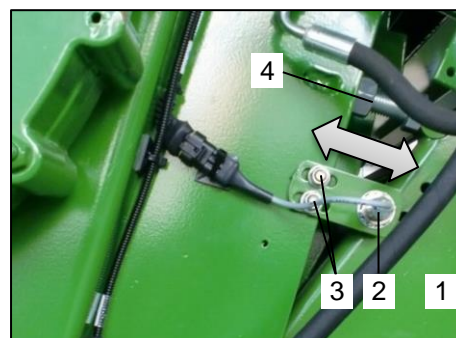



Image 93: Setting sensors



To adjust the distance between sensor and signaller, observe the notes and follow the instructions in the operating instructions, chapter "Functions and settings", section "Electrical system" / "Setting sensors".

5.18.5 Upper front wall sensor (left)

Pos. 1:	Upper front wall sensor (left)
Function:	Auto-load (volume)
Version:	Inductive sensor "NO contact"
LED on:	 The filler hood is raised so far that the signaller has been triggered. The scraper floor is switched on automatically and is operated until the filler hood is lowered again.
LED off:	 The filler hood is not raised, the signaller is not triggered.

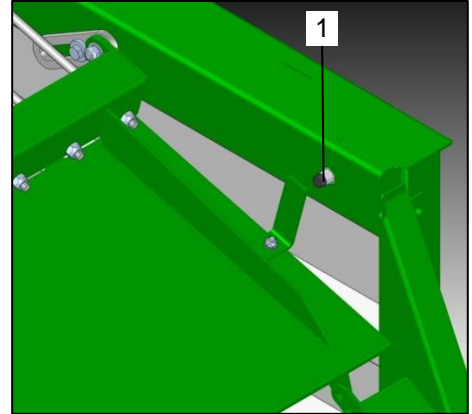

Image 94: Upper front wall sensor

Description:

With the auto-load function, the scraper floor automatically starts up when the cargo space reaches a defined filling height. The movement of the filler hood (Image 95 / pos. 1) is detected by a sensor (Image 94 / pos. 2).

Setting:

The sensor (Image 95 / pos. 2) and the signaller (Image 95 / pos. 3) at the filler hood (Image 95 / pos. 1) are optimally preset and positioned on delivery of the vehicle. A change of the position of the signaller (Image 95 / pos. 3) or the sensor (Image 95 / pos. 2) is not possible.

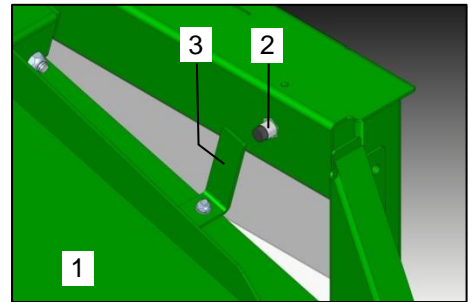

Image 95: Setting sensors



The delay of the start and stop time of the auto-load can be modified. Observe the notes and instructions in the separate operating instructions of the terminal in the "Operation" chapter.



To adjust the distance between sensor and signaller, observe the notes and follow the instructions in the operating instructions, chapter "Functions and settings", section "Electrical system" / "Setting sensors".

5.18.6 Dosing Unit Sensor Right

Pos. 1:	Dosing Unit Sensor Right
Function:	Level indicator (type S)
Design	Inductive sensor "Opener"
LED on:	The dosing roller is moved back and the terminal display signals "FULL" in the "Loading" menu.
LED off:	The dosing roller is positioned completely to the front and thus in the rest position.

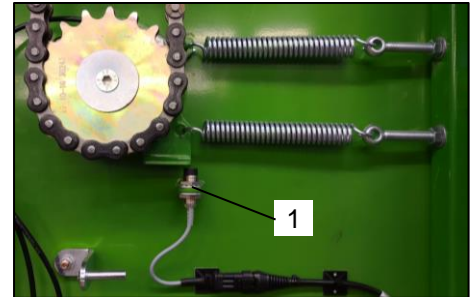

Fig. 1: Dosing Unit Sensor Right

Description:

Loading:

When the material reaches the lower dosing roller during loading, the dosing roller is moved backwards (max. 10 mm) against the force of the tension springs. This dosing roller movement is registered by a sensor, the transport floor is stopped and the terminal display signals "FULL".

Unloading:

If the scraper floor feeds too quickly for the dosing rollers during unloading (the roller is pushed back) the scraper floor stops until the dosing rollers have worked themselves free again.

Setting:

The Sensor (Fig. 2 / Pos. 1) on the lower dosing roller (Fig. 2 / Pos. 2) is deactivated. The dosing roller (Fig. 2 / Pos. 2) is located in the forward most position. Taking into account the distance "X" between sensor (Fig. 2 / Pos. 1) and signal transmitter (Fig. 2 / Pos. 3) the spring force in the tension springs (Fig. 2 / Pos. 4) is adjusted. The following applies:

Screw in the screws:	Screw out the screws
- Increase spring force in tension springs	- Decrease spring force in tension springs
- Scraper floor stops later	- Scraper floor stops sooner

When making adjustments, proceed as follows:

- Loosen the two nuts (Fig. 2 / Pos. 5).
- Adjust the spring force of the tension springs (Fig. 2 / Pos. 4) by turning the screws (Fig. 2 / Pos. 6) in or out. Ensure that both screws (Fig. 2 / Pos. 6) are adjusted equally.
- Retighten the two nuts (Fig. 2 / Pos. 5).

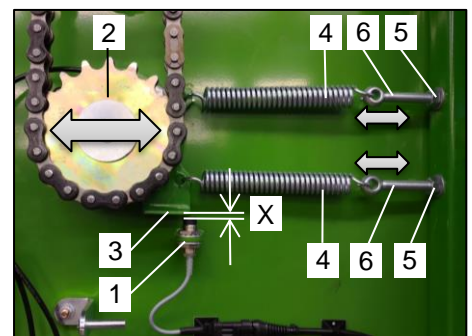

Fig. 2: Sensor settings



If the distance "X" between the sensor (Fig. 2 / Pos.1) and the signal transmitter (Fig. 2 / Pos.3) is to be adjusted, observe instructions the operating instructions in the chapter "Function and Settings" in the "Electric" / "Sensor Setting" section!

5.18.7 Tailgate Sensor, Bottom (Left & Right)



Pos. 1:	Tailgate sensor, bottom (left & right)
Function:	Level indicator (type K)
Design	Inductive sensor "Opener"
LED on:	 The tailgate is slightly open on both sides and the terminal display signals "FULL".
LED off:	 The tailgate is completely closed and is not under load.



Image 96: Tailgate sensor

Description:

If the vehicle is not equipped with a dosing unit, the tailgate assumes the level indicator function. If the harvested material reaches the tailgate during loading, the tailgate opens slightly. When the sensors on the left and right register the opening, the transport floor is switched off and the terminal signals "FULL".

Setting:

The sensors are optimally set and positioned at the factory. It is not possible to adjust their position.





If the distance "X" between the sensor and the signal transmitter is to be adjusted, observe instructions the operating instructions in the chapter "Function and Settings" in the "Electric" / "Sensor Setting" section!

6 Operation

Chapter "Operation" contains information on the possible machine controls. It describes the individual functions, the handling and the procedure for operating the vehicle using a terminal.

The components and vehicle functions listed in the operating instructions may differ from the vehicle standard equipment and are available as optional equipment in some cases. Since these operating instructions are general, various equipment options can be listed that are not available for your trailer. This also applies to the images. Images, drawings and 3D illustrations in these operating instructions do not always represent the exact vehicle type. However, the information which refers to the illustrations always corresponds to the vehicle type in this document.

	WARNING!
	<p>Failure to observe the safety instructions may result in serious injury or death.</p> <ul style="list-style-type: none"> • In order to prevent accidents, the operator of the vehicle must read and observe the safety instructions in the "Safety" chapter.

	WARNING!
	<p>Reaching into the vehicle can cause crushing, shearing, cutting, severing, being caught, entangled, pulled in and struck in the vehicle.</p> <p>These hazards may arise when</p> <ul style="list-style-type: none"> - the unsecured tractor and the trailer unintentionally roll, - driven tools and drives are not switched off, - hydraulic functions are activated unintentionally, - tools or vehicle components are in operation, - the tractor engine is switched on inadvertently, - raised vehicle components are lowered inadvertently. <p>These dangers exist during all work on the vehicle through unintentional contact with driven, unsecured tools and drives, which may run on after being switched off, and through raised, unsecured parts of the vehicle.</p> <ul style="list-style-type: none"> • Therefore the vehicle must be secured against unintentional rolling and starting before any work is done on the machine, e.g. making adjustments or correcting malfunctions. <p>  For this, the notices and instructions in the operating instructions in section "Commissioning" under "Securing the vehicle against unintentional rolling and starting" are to be observed. </p>



Observe also the notes and instructions in the additional operating instructions for the machine control units. The operating instructions are supplied as separate, printed documents with your vehicle documents. If you do not have these documents, you can find them on the CD at the end of these operating instructions.

6.1 Terminal BCT20

The hydraulic functions are operated using the BCT20 terminal. The terminal is characterized by

- ON/OFF for terminal,
- rotary / push button,
- ergonomically arranged keys,
- back-lit membrane keypad,
- backlit display,
- freely programmable sequence control of individual functions,
- trip counter,
- a variety of functions.



Fig. 97: Terminal BCT20

Additional hydraulic functions without control block connection have no terminal functionality. Such functions can be operated directly by the tractor control units according to the hydraulic system manual control after coupling the supply lines to the tractor.



For this, observe the notices and instructions in the operating instructions in chapter "Functions and Settings" in the "Hydraulics" section.

	<p>NOTICE</p>
	<ul style="list-style-type: none"> • Protect the terminal from water. • Store the terminal in a dry room if it is not used for a long period (e.g. in winter). • Disconnect the power supply during installation and repair work. Remove all electronic components (terminal, BSG, ISO-Gate, etc.) during welding work. Overvoltage can damage the terminal's electronics.

6.1.1 BCT20 Terminal User Surface

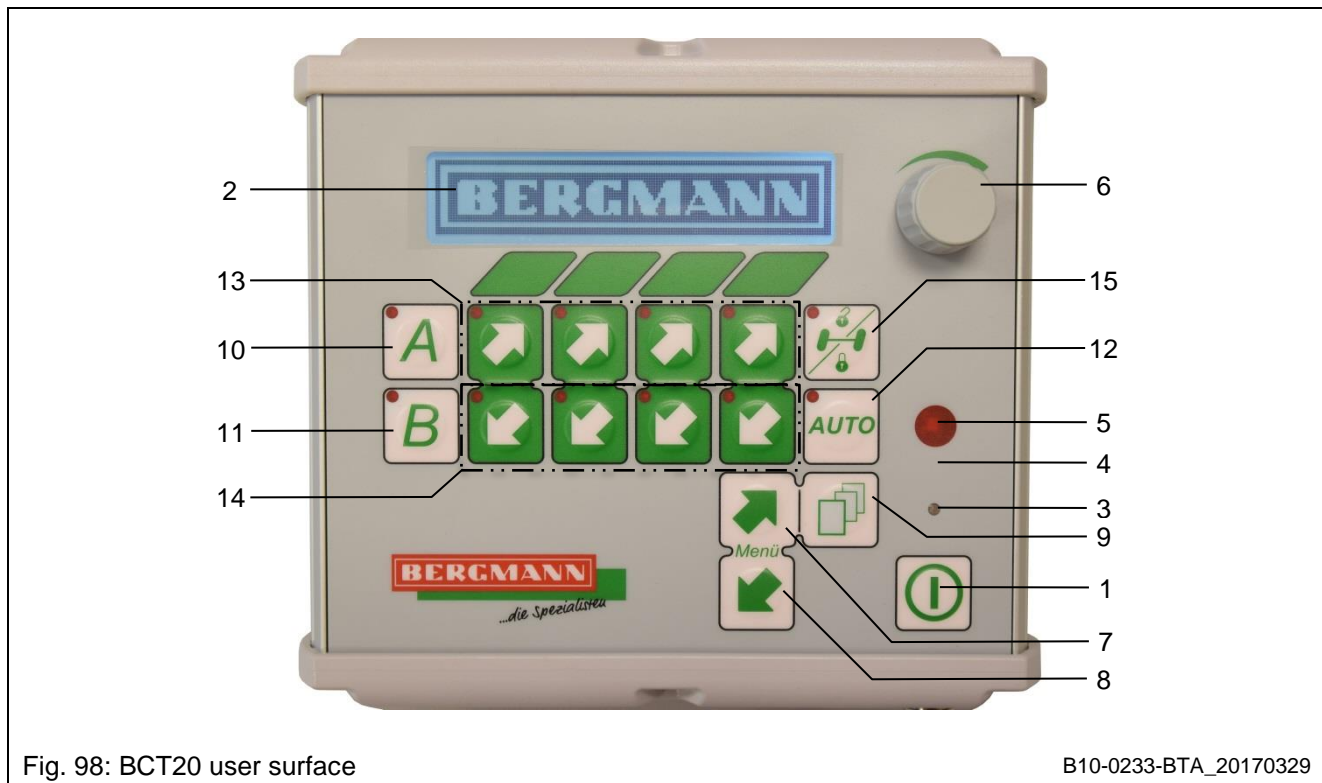









Fig. 98: BCT20 user surface

B10-0233-BTA_20170329

1	Main switch		Switching the terminal On / Off
2	Display		Menu display with the respective functions
3	Light sensor		Controls the back lighting.
4	Signal horn		Signals e.g. "FULL" or "Scraper floor stop" (In combination with the light)
5	Indicator light		Signals e.g. "FULL" or "Scraper floor stop" (In combination with the signal horn)
6	Rotary / push button		For changing and confirming settings such as the transport floor speed.
7	Next menu		For changing the menu.
8	Previous menu		For changing the menu.
9	Shift key		For calling up further functions within a menu.

10	Function memory "A"		<p>Programmable sequence of different functions</p> <ul style="list-style-type: none"> - Press and hold the key: Functions are called up. - Release the key: Stop function sequence. - Pressing and holding the key again within 2 seconds: Function continues.
11	Function memory "B"		<ul style="list-style-type: none"> - Pressing and holding the key again after 2 seconds: Restarts functions from the beginning. <p><u>Setting Mode:</u></p> <ul style="list-style-type: none"> - Press briefly: Setting mode opens. - Press briefly: The setting mode is closed and settings are saved.
12	Auto key		To activate automatic functions, e.g. permanent activation of the transport floor or automatic filling system (depending on machine type and menu level)
13	Function keys forward / up		Operating the functions shown in the display
14	Function key back / down		Operating the functions shown in the display
15	Steering axle Lock / Unlock:		<p>Operating the steering axle function</p> <p> Unlock: Press key once briefly (Unlocked: red LED lights up)</p>
			<p> Lock: Press key once briefly (Blinking LED: Controller closes steering axle Locked: red LED off,)</p>

Other machine functions (e.g. work light, tailgate, jack stand, etc.) can be called up by pressing the shift key (Fig. 98 / Pos.9) and can be operated using the function keys (Fig. 98 / Pos.13+14).

6.1.2 Quick Start with BCT20 Terminal

1.	Switch the terminal on.	Press main switch
2.	Select menu	<ul style="list-style-type: none"> - 2/4: Unloading - 4/4: Loading
3	Switch PTO shaft on	Observe the speed depending on equipment and type!
4.	Switch oil supply on.	Not necessary with load sensing
5.	Select function	e.g. Lower pick-up etc.
6.	Switch scraper floor on	Press the Auto key
7.	Set scraper floor speed	<p>Turn only:</p> <ul style="list-style-type: none"> - Changes the current scraper floor speed <p>Turn and press once:</p> <ul style="list-style-type: none"> - Changes the saved scraper floor start speed

6.1.3 BCT20 Terminal Menu Structure











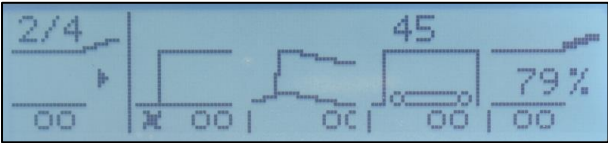



The individual menus are structured as follows:











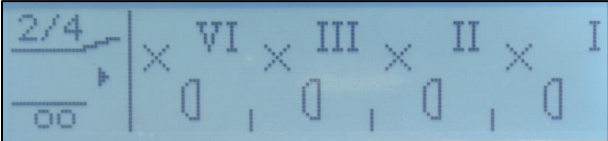









1/4		Driving on Roads
2/4		Unloading
3/4		Trip counter
4/4		Loading







6.1.3.1 Menu 1/4: Driving on roads

Menu 1/4 / Function block 1:				
-	-	-	-	-
-	-	-	-	-
-	-	-	-	-
	Work light III / All-round lighting		On	
			Off	

6.1.3.2 Menu 2/4: Unloading

Menu 2/4 / Function block 1:												
												
	Pick-up	 	Raise									
			Float position:	Press key once briefly								
	Drawbar	 	Raise									
			Lower									
	Scrapper Floor	   	Switch scrapper floor on permanently The LED lights when the scrapper floor is switched on.									
			Adjust scrapper floor speed The set speed is displayed above the transport floor pictogram.									
			Back									
			Forward (reverse)									
	Tailgate	 	Raise	<table border="1"> <tr> <td>0%:</td> <td>Tailgate is completely closed.</td> </tr> <tr> <td>1 - 10%</td> <td>Tailgate is raised and in locked / unlocked position.</td> </tr> <tr> <td>11 - 99%</td> <td>Tailgate is partially open.</td> </tr> <tr> <td>100 %:</td> <td>Tailgate is completely closed.</td> </tr> </table>	0%:	Tailgate is completely closed.	1 - 10%	Tailgate is raised and in locked / unlocked position.	11 - 99%	Tailgate is partially open.	100 %:	Tailgate is completely closed.
			0%:	Tailgate is completely closed.								
1 - 10%	Tailgate is raised and in locked / unlocked position.											
11 - 99%	Tailgate is partially open.											
100 %:	Tailgate is completely closed.											
Lower												

Menu 2/4 / Function block 2:				
				
	Light VI	 	On	
			Off	
	Light III	 	On	
			Off	
	Light II	 	On	
			Off	
	Light I	 	On	
			Off	

Menu 2/4 / Function block 3:				
				
-	-	-		
-	-	-		
	Front wall bottom element	 	Back	0%: Front wall completely in cargo space <hr/> 100%: Front wall moved completely toward tractor
			Forward	
	Front wall top element:	 	Raise	
			Lower	

6.1.3.3 Menu 3/4: Trip counter

Menu 3/4 / Function block 1:			
	Memory 1 - 10		Trip counter up
			Trip counter down
	= Trip counter off AUTO = Trip counter on		Activate / Deactivate
			Activate / Deactivate
	Time		-
			Activate / Deactivate: timed Press and hold for 2 seconds and release again to delete the value.
Example: 8.4 h = 8 hours and 24 min. (4 x 6 min = 24 min)			
	Number of trips		Increase the number of trips step by step.
			Decrease the number of trips step by step. Press and hold for 2 seconds and release again to delete the value.
1 trip = 0.5 min. transport floor on + 4 min. transport floor paused			

Menu 3/4 / Function block 2:			
	Memory 1 - 10		Trip counter up
			Trip counter down
	Load capacity		Increase load capacity
			Decrease load capacity
	Delivered volume		Increase value step by step
			Decrease value step by step Press and hold for 2 seconds and release again to delete the value.
	Loading time		Increase value step by step
			Decrease value step by step Press and hold for 2 seconds and release again to delete the value.

Menu 3/4 / Function block 3:	
	Total time
	Total trips
Σm^3	Total delivered volume
	Total loading time

6.1.3.4 Menu 4/4: Loading

Menu 4/4 / Function block 1:			
	Cutting unit completely retracted		Raise
	Cutting unit not completely retracted		Lower
	Cutting unit completely extended		Lower
	Drawbar		Raise
	Drawbar		Lower
	Scraper Floor		Switch scraper floor on permanently The LED lights when the scraper floor is switched on.
			Adjust scraper floor speed The set speed is displayed above the transport floor pictogram.
			Back
			Forward (reverse)
	Pick-up		Raise
			Float position:

Menu 4/4 / Function block 2:

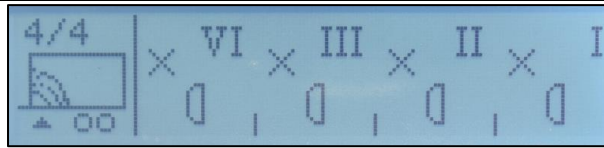

	Light VI		On	
			Off	
	Light III		On	
			Off	
	Light II		On	
			Off	
	Light I		On	
			Off	

Menu 4/4 / Function block 3:

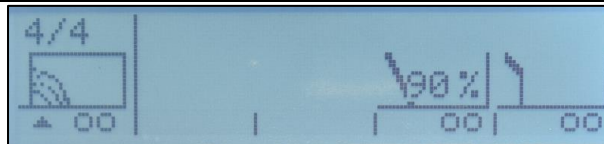

-	-	-		
-	-	-		
	Front wall bottom element		Back	0%: Front wall completely in cargo space
			Forward	100%: Front wall moved completely toward tractor
	Front wall top element:		Raise	
			Lower	

6.2 ISOBUS terminal CCI50 / CCI200

The hydraulic functions are operated using the CCI50 / CCI200 terminal. The terminals are characterised by

- ISOBUS UT function (certified), for operating existing ISOBUS machines,
- ISOBUS AUX-N function (certified), for assigning machine functions to a joystick,
- Large, clear displays (CCI50 - 5.6" diagonal, CCI200 - 8.3" diagonal)
- Illuminated display with membrane keypad,
- Touch screen for intuitive operation,
- Ergonomically arranged keys, with the possibility to mirror them from left to right,
- ISB switch for stopping machine functions (depending on the machine),
- Interfaces incl. USB, video and more.
- Up to eight video cameras possible,
- Optional wide range of apps: CCI.CONTROL, CCI.COMMAND, CCI.CAM, CCI.TECU etc.,



Fig. 99: CCI terminal



For this, the instructions and notices in the separate operating instructions for the "CCI 50 / CCI 200 terminal" machine controls must also be observed!

Additional hydraulic functions without control block connection have no terminal functionality. Such functions can be operated directly by the tractor control units according to the hydraulic system manual control after coupling the supply lines to the tractor.



For this, observe the notices and instructions in the operating instructions in chapter "Functions and Settings" in the "Hydraulics" section.

	NOTICE
	<ul style="list-style-type: none"> • Protect the terminal from water. • Store the terminal in a dry room if it is not used for a long period (e.g. in winter). • Disconnect the power supply during installation and repair work. Remove all electronic components (terminal, BSG, ISO-Gate, etc.) during welding work. Overvoltage can damage the terminal's electronics.

6.2.1 CCI50 / CCI200 Terminal Operating Panel

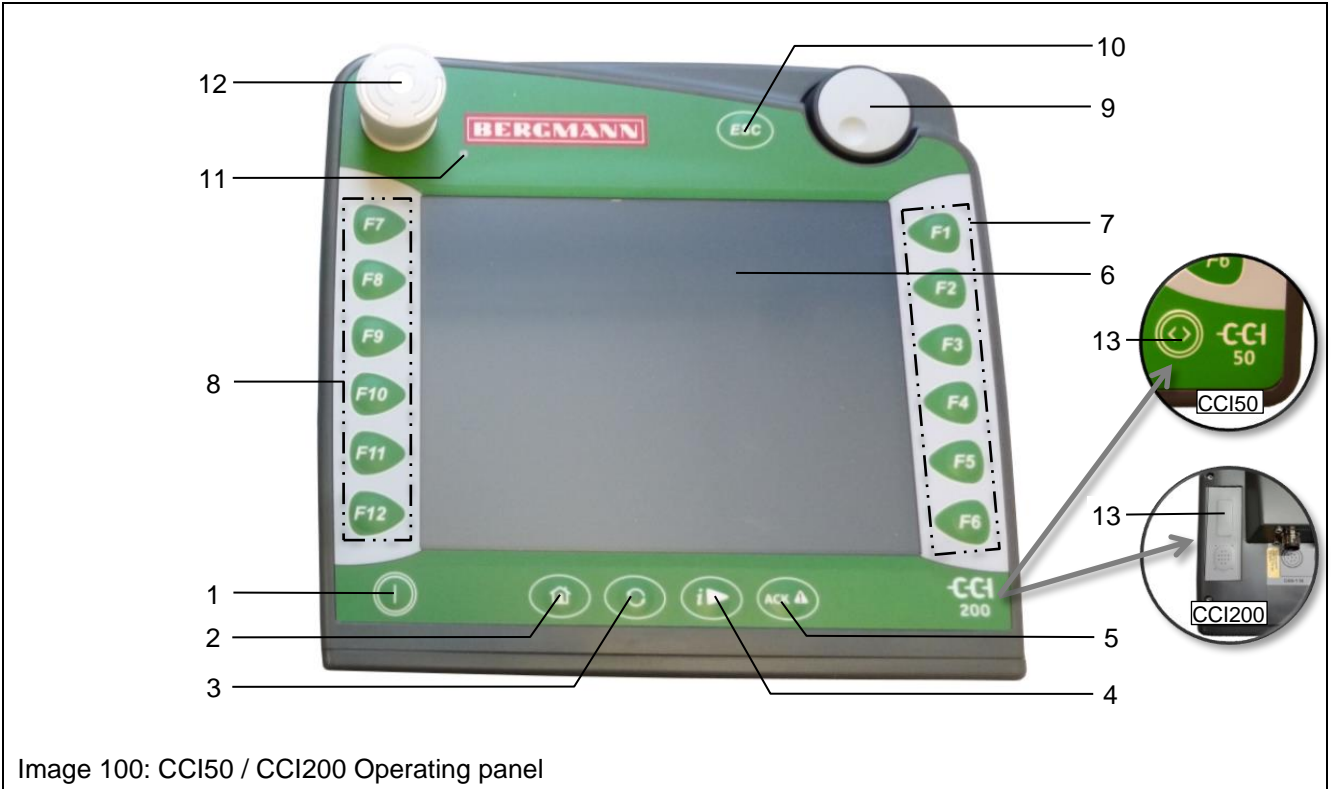







Image 100: CCI50 / CCI200 Operating panel

1	Main switch		Switching the terminal On / Off
2	Home key		Pressing the home button will take you directly to the main menu. Apps that are active at the time of the switch will remain active in the background. <u>Notice</u> When switching from an active machine function, some running machine functions may switch off automatically. More detailed information can be found in the machine operating instructions.
3	Switch key		Pressing the switch key repeatedly and shortly, switches sequentially between the machine operations and the individual apps, which are selected in the user settings under "Switch Apps", for example from machine operation to CCI.Control. <u>Notice</u> When switching from an active machine function, some running machine functions may switch off automatically. More detailed information can be found in the machine operating instructions.

4	i - key		The i key can be configured as desired. It allows direct access to an app or machine operation which is selected in the user settings under "Configuring unassigned keys".
5	Acknowledge key (ACK)		The acknowledgement key (ACK) is used to confirm error messages.
6	Touch screen		The terminal is equipped with a high-quality touch screen for menu navigation and convenient input of values and texts. By touching the screen, functions can be directly called up and values can be changed.
7	Function keys F1 – F6		Six function keys (F1-F12) are arranged to the right and left of the display. By pressing a function key, the function shown in the display next to the function key is executed.
8	Function keys F7 – F12		
9	Scroll wheel		<p>The scroll wheel is used for direct, fast input of set points and for navigation through list elements:</p> <p><u>Turning the scroll wheel to the right</u></p> <ul style="list-style-type: none"> - The value is increased in an input dialogue for numeric values. - The system switches to the next element in a list. <p><u>Turning the scroll wheel to the left</u></p> <ul style="list-style-type: none"> - The value is decreased in an input dialogue for numeric values. - The system switches to the previous element in a list. <p><u>Pressing the scroll wheel</u></p> <ul style="list-style-type: none"> - The changed value is confirmed. - A marked listed element is selected.
10	ESC key		<p>Pressing the ESC key cancels inputs and functions. Changes which were made are not accepted and the previously valid value is retained.</p> <p><u>Notice</u></p> <p>The ESC key can only be used if there is an ESC key on the control panel display which can be operated via the touch screen. The key and touch screen functions are identical.</p>
11	Day light sensor		The daylight sensor provides the value for the display illumination on/off switch point. The display illumination can be set in the terminal menu.

12	ISB switch (Stop switch)		A stop command (ISO stop) is sent to the ISOBUS when the terminal's ISB emergency stop button is pressed. This command can be evaluated using a connected ISOBUS machine in order to initiate appropriate automatic measures or to deactivate functions in a hazardous situation.
----	-----------------------------	--	---

	WARNING!
	<p>Risk of injury from running machines!</p> <p>Not all ISOBUS machines support the stop function. This means that a machine can continue to run even after the stop switch has been pressed. This can lead to injury.</p> <p>Under no circumstances does the stop switch affect tractor functions, meaning neither PTO shaft nor hydraulics are affected.</p>

13	Soft key switcher		<p>CCI50: Key located in front CCI200: Key located in rear</p> <p>By pressing the soft key switcher, the two soft-key rows on the left and right edge of the screen are switched. This makes one handed terminal operation possible.</p> <p><u>Notice</u></p> <p>The soft-key row positions can only be changed under machine operation.</p>
----	-------------------	--	--

6.2.2 CCI50 / CCI200 / ISOBUS Terminal Menu Design

1/4		Driving on Roads
2/4		Unloading
3/4		Trip counter
4/4		Loading

6.2.2.1 Menu 1/4: Driving on roads

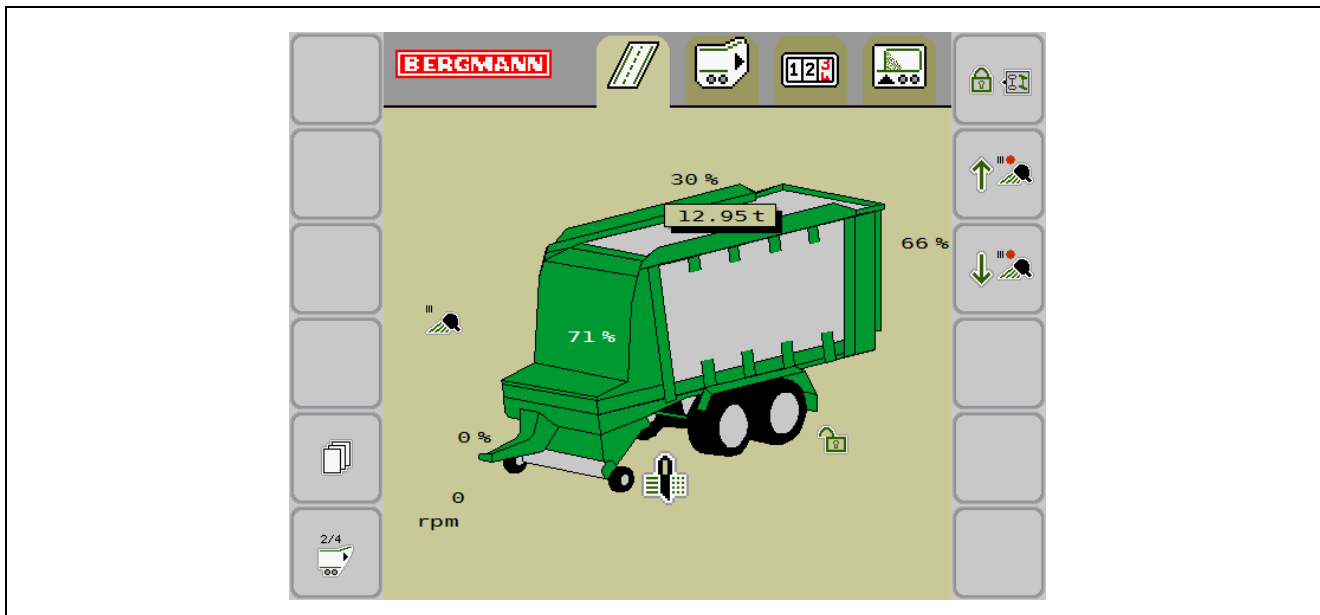

Menu







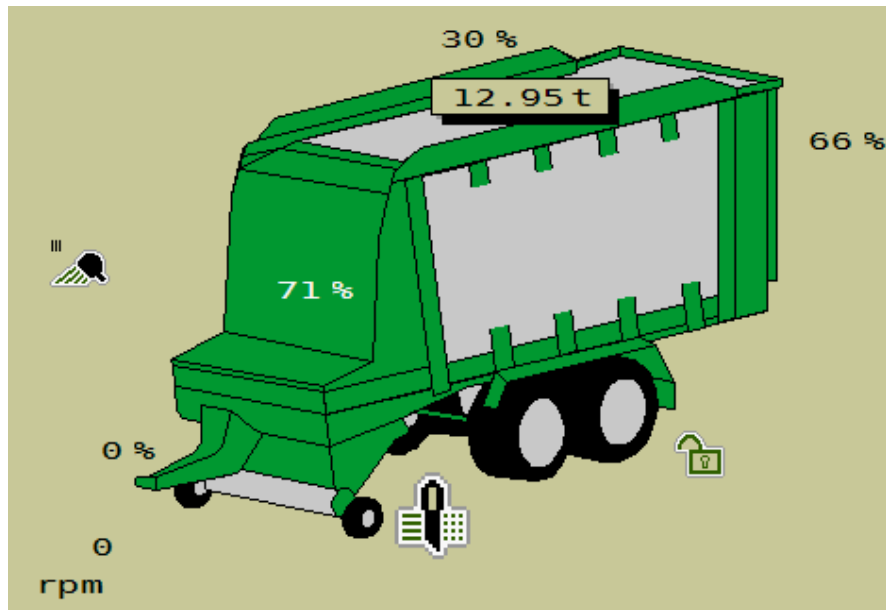



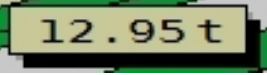

	Active menu 1/4 "Driving on Streets" – can be selected directly via touch or scroll wheel
	Inactive menu 2/4 "Unloading" – can be selected directly via touch or scroll wheel
	Inactive menu 3/4 "Trip Counter" – can be selected directly via touch or scroll wheel
	Inactive menu 4/4 "Loading" – can be selected directly via touch or scroll wheel

Soft keys

	Paging through further functions not possible in this menu
	Change to menu 2/4 "Unloading" Press and hold: Service Access
	Open steering axle
	Close steering axle
	Switch work light III / surrounding lights on (Display shows that work light is off)
	Switch work light 3 / surrounding lights off (Display shows that work light is on)

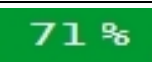

Data mask

	Steering axle open
	Steering axle closed; blinks in display: Controller closes steering axle
	Payload in t
	Fill level information (100% = full)
	Tailgate opening 0% = closed 100% = completely open
	Cutting unit completely retracted
	Cutting unit not completely retracted
	Cutting unit completely extended
	PTO speed in RPM
	Drawbar position 0% = drawbar up (cylinder retracted) 100% = drawbar down (cylinder extended)
	Front wall position 0% = front wall in cargo space 100% = front wall out of cargo space
	Work light III switched on

6.2.2.2 Menu 2/4: Unloading

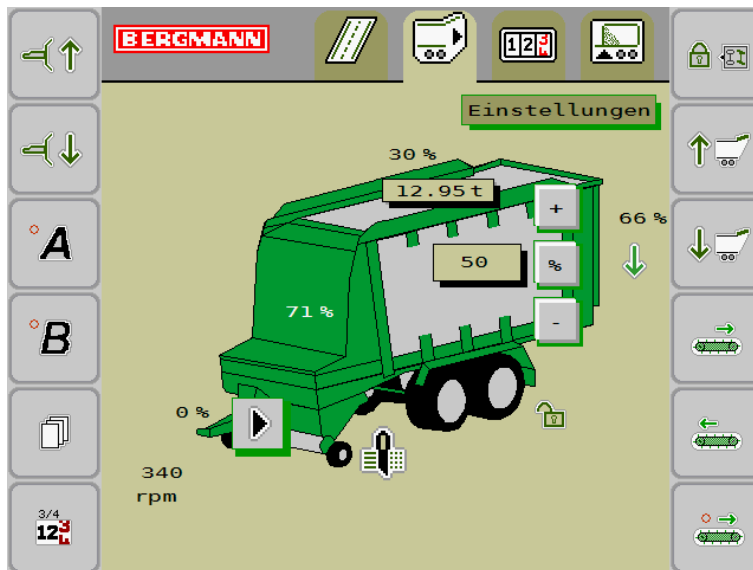





















Menu

	Inactive menu 1/4 "Driving on Street" – can be selected directly via touch or scroll wheel
	Inactive menu 2/4 "Unloading" – can be selected directly via touch or scroll wheel
	Inactive menu 3/4 "Trip Counter" – can be selected directly via touch or scroll wheel
	Inactive menu 4/4 "Loading" – can be selected directly via touch or scroll wheel







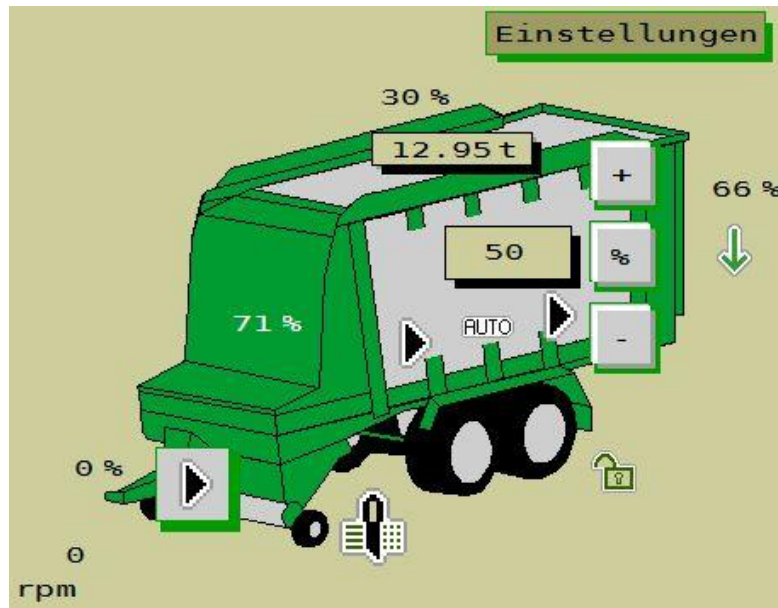



Soft keys

	Change to menu 3/4 "Trip Counter" Press and hold: Service Access
	Browse for more functions
	See the following section "Function sequences A and B".
	See the following section "Function sequences A and B".
	Open steering axle
	Close steering axle
	Switch scraper floor on Automatic speed control With this display, the scraper floor is switched off.
	Scraper floor off (Automatic) With this display, the scraper floor is switched on.

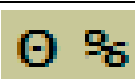

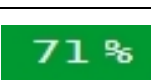

	Reverse scraper floor
	Scraper floor manual in unloading direction, control in % mode
	Lower drawbar With coupled machine Raise machine
	Raise drawbar With coupled machine Lower machine
	Raise pick-up
	Lower pick-up (working position)
	Raise front wall top element
	Lower front wall top element
	Move front wall bottom element forward (toward the tractor)
	Move front wall bottom element back (toward the cargo space)
	Raise tailgate
	Lower tailgate
	Switch spotlight I on (Display shows that work light is off)
	Switch spotlight I off (Display shows that work light is on)
	Switch spotlight II on (Display shows that work light is off)
	Switch spotlight II off (Display shows that work light is on)
	Switch work light III / surrounding lights on (Display shows that work light is off)
	Switch work light 3 / surrounding lights off (Display shows that work light is on)
	Switch work light VI / surrounding lights on (Display shows that work light is off)
	Switch work light VI / surrounding lights off (Display shows that work light is on)











Data mask	
	Go to submenu "Settings"
	Display and input field current scraper floor speed
	Increase scraper floor speed in steps
	Decrease scraper floor speed in steps
	Increase scraper floor speed to 100%
	Scraper floor 1. Gear
	Scraper floor 2. Gear (overdrive for emptying)
	Scraper floor automatically on
	Steering axle open
	Steering axle closed; blinks in display: Controller closes steering axle
	Payload in tons
	Fill level information (100% = full)
	Tailgate opening 0% = closed 100% = completely open
	Preset value exceeded. When value is not reached: Additional key for automatic opening to preset value.

	Cutting unit completely retracted
	Cutting unit not completely retracted
	Cutting unit completely extended
	Run pick-up by touch
	Drawbar position 0% = drawbar up (cylinder retracted) 100% = drawbar down (cylinder extended)
	PTO speed in RPM
	Front wall position 0% = front wall in cargo space 100% = front wall out of cargo space
	Work light I switched on
	Work light II switched on
	Work light III switched on
	Work light VI switched on







6.2.2.2.1 Function sequences A and B

<u>Function sequence A:</u>	
 inactive	Hold key: Stored functions run in sequence. Release key: Function stops.
 active	Press key briefly "Settings A" screen opens, briefly pressing the key again closes the "Settings A" screen and saves the settings.
<u>Function sequence B:</u>	
 inactive	Hold key: Stored functions run in sequence. Release key: Function stops.
 active	Press key briefly: "Settings B" screen opens, briefly pressing the key again closes the "Settings B" screen and saves the settings.

Notice on Function sequences

	
A: Step 1: Raise machine for 3.0 seconds.	
	
B: Step 1: Lower machine for 3.0 seconds.	
	Settings for function sequence A
	Settings for function sequence B
	Step number: Up to eight functions can be stored Step 1 is the first function and step 8 is the last function It is possible to select via touch or scroll wheel
	Function selection field All displayed functions can be selected It is possible to select via touch or scroll wheel
	Selecting the direction or mode Up/back, down/forward, off (X) or on (Auto) It is possible to select via touch or scroll wheel
	Duration for this step Settings from 0 to 25 seconds in 0.1 second steps It is possible to select via touch or scroll wheel

Special functions





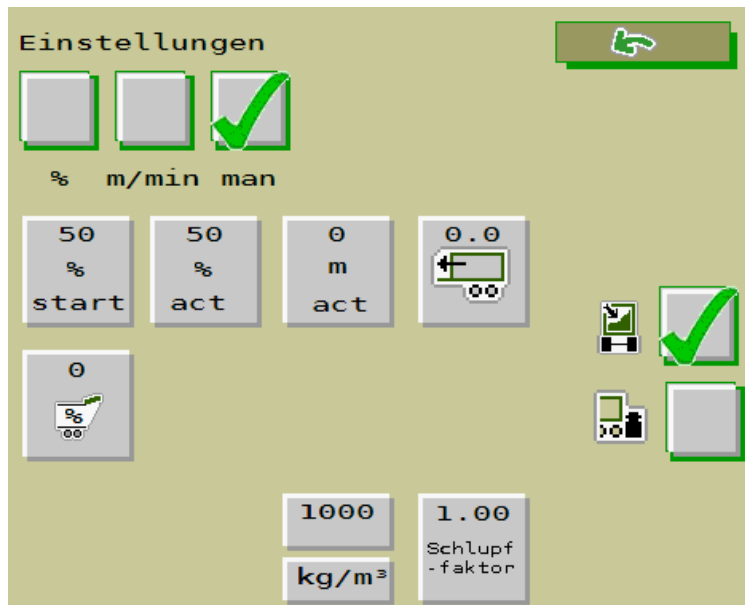





 AUTO 0.1 sec	<p>Scrapper floor (Automatic) on</p>
 X 0.1 sec	<p>Scrapper floor (Automatic) off</p>
 AUTO 0.1 sec	<p>Open steering axle</p>
 X 4.0 sec	<p>Close steering axle</p>
 ↗ 0.1 sec	<p>Work light on</p>
 ↙ 0.1 sec	<p>Work light off</p>

6.2.2.2.2 Settings





Data mask

	Indicator: Submenu "Settings"
	Return to main menu "Unloading"
	Scrapper floor mode "Manual adjustment" A green tick means that this mode is activated For this, also observe the instructions and notices in the operating instructions in the "Scrapper Floor Mode" section!
	Scrapper floor mode "Controlling the scrapper floor speed" For this, also observe the instructions and notices in the operating instructions in the "Scrapper Floor Mode" section!
	Scrapper floor mode "Controlling the unloading length, fixed driving speed" For this, also observe the instructions and notices in the operating instructions in the "Scrapper Floor Mode" section!
	Scrapper floor speed in %: current value, or set value
	Scrapper floor speed in %: Start value - the current value of the scrapper floor is replaced by the starting value when the scrapper floor is switched off.
	Scrapper floor speed in m/min: current value, or set value
	Scrapper floor speed in m/min: Start value - the current value of the scrapper floor is replaced by the starting value when the scrapper floor is switched off.
	Desired swath length in meters

	<p>Driving speed in km/h</p>
	<p>Set tailgate height 0% = closed 100% = completely open</p>
	<p>Delay time Start automatic loading system Example: 0 seconds = scraper floor starts immediately after sensor signal 2 seconds = scraper floor starts 2 seconds after sensor signal Increase value for dry material!</p>
	<p>Delay time stop automatic loading system Example: 0 seconds = scraper floor stops immediately after inactive sensor signal 2 seconds = scraper floor stops 2 seconds after inactive sensor signal Increase value for moist material!</p>
	<p>Cutting mode activated</p>
	<p>Cutting mode deactivated</p>
	<p>Weight summation activated</p>
	<p>Weight summation deactivated</p>
	<p>Density setting</p>
	<p>Key for setting the density For determining the material density using the currently loaded weight, the corresponding volume is inquired using the input mask.</p>
	<p>Slip factor setting Standard value 1.00 Factor 2.00: double scraper floor speed Factor 0.50: half scraper floor speed</p>











6.2.2.2.3 Scaper floor mode











Switching is carried out via touch or scroll wheel by directly selecting the icons

	<p>Manual settings</p> <p>Control in % of the maximum possible scraper floor speed; at 70% overdrive is switched on automatically (if available)</p>
	<p>Scrapper floor speed control</p> <p>Controlling scraper floor speed in meters per minute Example: 1.25 m/min means that the scraper floor moves exactly 1.25 m toward the back in one minute. Overdrive switches on automatically when a factory-preset speed is reached.</p>
	<p>Unloading length control, fixed driving speed:</p> <p>Based on the entered values of swath length and driving speed, the controller regulates the scraper floor speed according to the desired swath length. The second stage switches on automatically when a factory-preset speed is reached.</p>

6.2.2.3 Menu 3/4: Trip counter







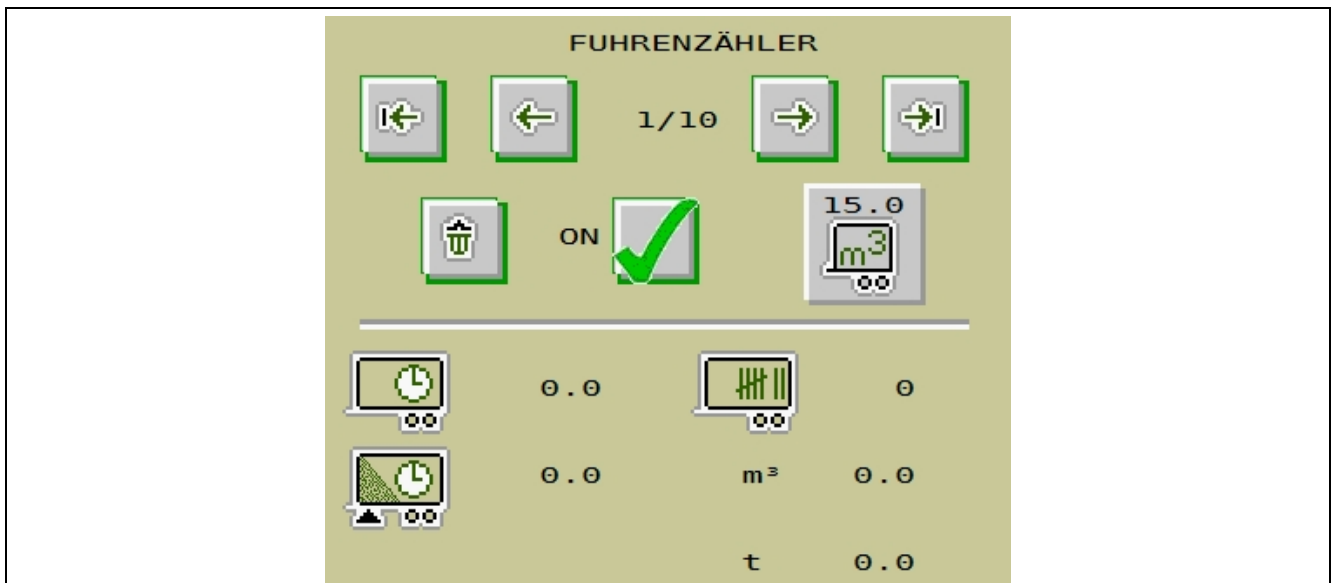

Menu	
	Inactive menu 1/4 "Driving on Street" – can be selected directly via touch or scroll wheel
	Inactive menu 2/4 "Unloading" – can be selected directly via touch or scroll wheel
	Active menu 3/4 "Trip Counter" – can be selected directly via touch or scroll wheel
	Inactive menu 4/4 "Loading" – can be selected directly via touch or scroll wheel
Soft keys	
	Deactivate trip counter memory
	Deactivate trip counter memory
	Activate trip counter memory
	Activate trip counter memory
	Increase trip counter memory
	Decrease trip counter memory
	Browse for more functions

	<p>Change to menu 4/4 "Loading" Press and hold: Service Access</p>
	<p>Open steering axle</p>
	<p>Close steering axle</p>
	<p>Increase the number of trips step by step.</p>
	<p>Decrease the number of trips step by step. Press and hold: When released the number of trips in this memory location will be deleted</p>
	<p>No function</p>
	<p>Press and hold: When released the time in this memory location will be deleted</p>
	<p>Increase load capacity</p>
	<p>Decrease load capacity</p>
	<p>Indicator for increasing spread volumes in steps</p>
	<p>Indicator for decreasing spread volumes in steps Press and hold: When released the spread volumes indicator in this memory location will be deleted</p>



Data mask



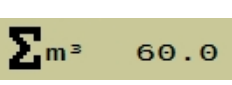
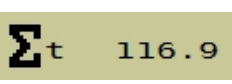

FUHRENZÄHLER	Notice: Trip counter indicator information
	Return to first memory location
	Back one memory location
1 / 10	Trip counter memory, 1/10 to 10/10
Σ	Total (= Σ)
TC	TC – memory: Information that is sent to Task-Controller.
	One memory location forward
	Forward to last memory location
	Delete all counters in current memory location
ON	The displayed memory location is active; Memory location deactivates when pressed
ON	The displayed memory location is inactive; Memory location activates when pressed
	Bin volume display and entry
0.0	Display time for current memory location: Example: 8.4 h = 8 hours and 24 min. (4 x 6 min = 24 min)
0.0	Display loading time for current memory: Example: 8.4 h = 8 hours and 24 min. (4 x 6 min = 24 min)

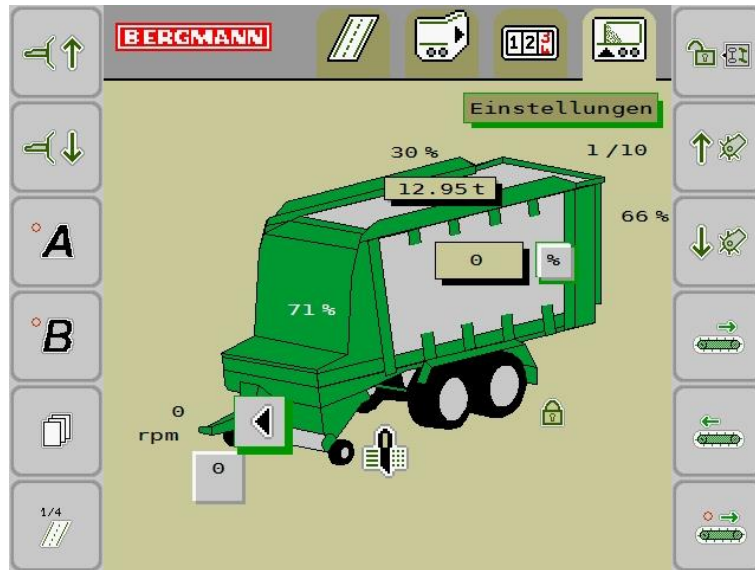
	Display trips for current memory location: 1 trip = 0.5 min. transport floor on + 4 min. transport floor paused
	Display spread volume for current memory location:
	Display spread mass for current memory location:
	Total time
	Total loading time
	Total number of trips
	Total volume
	Total mass









6.2.2.4 Menu 4/4: Loading



Menu

	Inactive menu 1/4 "Driving on Street" – can be selected directly via touch or scroll wheel
	Inactive menu 2/4 "Unloading" – can be selected directly via touch or scroll wheel
	Inactive menu 3/4 "Trip Counter" – can be selected directly via touch or scroll wheel
	Inactive menu 4/4 "Loading" – can be selected directly via touch or scroll wheel

Soft keys





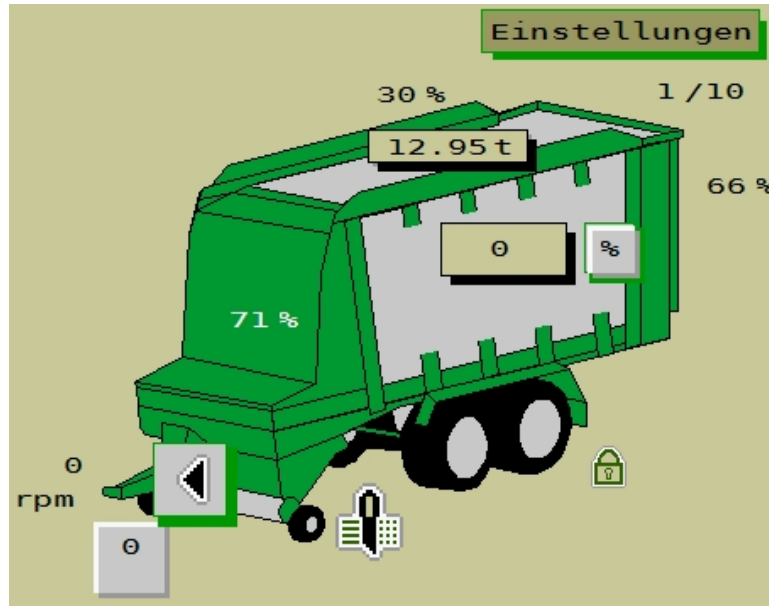

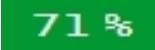

	Change to menu 1/4 "Driving on streets" Press and hold: Service Access
	Browse for more functions
 inactive	See the following section "Function sequences A and B".
 inactive	See the following section "Function sequences A and B".
	Open steering axle
	Close steering axle
	Switch scraper floor on Automatic: Speed control With this display, the scraper floor is switched off.
	Scraper floor off (Automatic) With this display, the scraper floor is switched on.

	Reverse scraper floor
	Scraper floor manual in unloading direction, control in % mode
	Lower drawbar With coupled machine Raise machine
	Raise drawbar With coupled machine Lower machine
	Raise pick-up
	Lower pick-up (working position)
	Raise cutting unit
	Lower cutting unit
	Raise front wall top element
	Lower front wall top element
	Move front wall bottom element forward (in the direction of the tractor)
	Move front wall bottom element back (toward the cargo space)
	Switch spotlight I on (Display shows that work light is off)
	Switch spotlight I off (Display shows that work light is on)
	Switch spotlight II on (Display shows that work light is off)
	Switch spotlight II off (Display shows that work light is on)
	Switch work light III / surrounding lights on (Display shows that work light is off)
	Switch work light 3 / surrounding lights off (Display shows that work light is on)
	Switch work light VI / surrounding lights on (Display shows that work light is off)
	Switch work light VI / surrounding lights off (Display shows that work light is on)







Data mask









	Go to submenu "Settings"
	Display active trip counter memory
	Fill level information (100% = full)
	Tailgate opening 0% = closed 100% = completely open
	Payload in t
	Display and input field current scraper floor speed
	Increase scraper floor speed to 100%
	Scraper floor automatically on
	Steering axle open
	Steering axle closed; blinks in display: Controller closes steering axle
	Cutting unit completely retracted
	Cutting unit not completely retracted
	Cutting unit completely extended
	PTO speed in RPM

	Front wall position 0% = front wall in cargo space 100% = front wall out of cargo space
	Reverse pick-up
	Pick-up contact pressure
	Pick-up float position or working position activated
	Work light I switched on
	Work light II switched on
	Work light III switched on
	Work light VI switched on







6.2.2.4.1 Function sequences A and B

<u>Function sequence A:</u>	
 inactive	Hold key: Stored functions run in sequence. Release key: Function stops.
 active	Press key briefly "Settings A" screen opens, briefly pressing the key again closes the "Settings A" screen and saves the settings.
<u>Function sequence B:</u>	
 inactive	Hold key: Stored functions run in sequence. Release key: Function stops.
 active	Press key briefly: "Settings B" screen opens, briefly pressing the key again closes the "Settings B" screen and saves the settings.

Notice on Function sequences

	
A: Step 1: Raise machine for 3.0 seconds.	
	
B: Step 1: Lower machine for 3.0 seconds.	
	Settings for function sequence A
	Settings for function sequence B
	Step number: Up to eight functions can be stored Step 1 is the first function and step 8 is the last function It is possible to select via touch or scroll wheel
	Function selection field All displayed functions can be selected It is possible to select via touch or scroll wheel
	Selecting the direction or mode Up/back, down/forward, off (X) or on (Auto) It is possible to select via touch or scroll wheel
	Duration for this step Settings from 0 to 25 seconds in 0.1 second steps It is possible to select via touch or scroll wheel







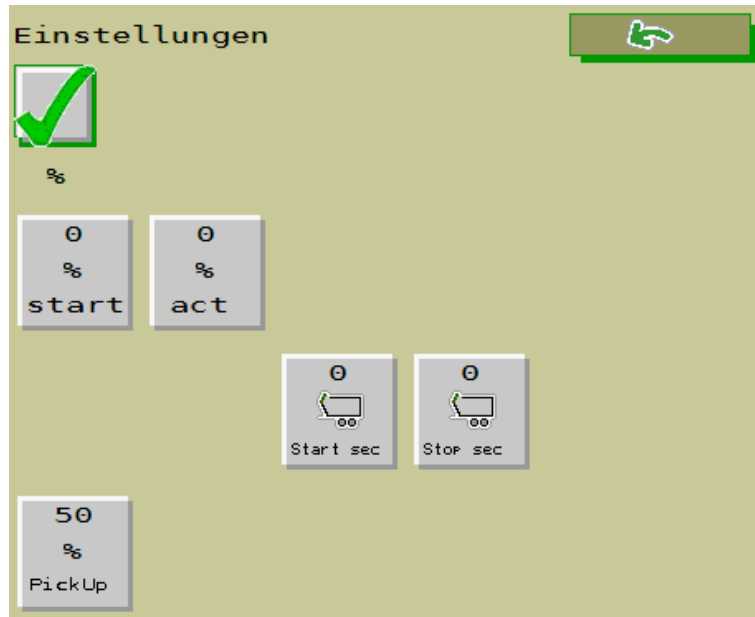

Special functions

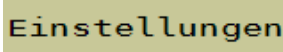
 AUTO 0.1 sec	Scaper floor (Automatic) on
 X 0.1 sec	Scaper floor (Automatic) off
 AUTO 0.1 sec	Open steering axle
 X 4.0 sec	Close steering axle
 ↗ 0.1 sec	Work light on
 ↙ 0.1 sec	Work light off
 ↙ 1.0 sec	Float position / working position active

6.2.2.4.2 Settings



Data mask

	Indicator: Submenu "Settings"
	Return to main menu "Unloading"
	<p>Scrapper floor mode "%" A green tick means that this mode is activated</p>  For this, also observe the instructions and notices in the operating instructions in the "Scrapper Floor Mode" section!
	Scrapper floor speed in %: Start value - the current value of the scrapper floor is replaced by the starting value when the scrapper floor is switched off.
	Scrapper floor speed in %: current value, or set value
	Pick-up speed in %
	<p>Delay time Start automatic loading system</p> <p>Example: 0 seconds = scrapper floor starts immediately after sensor signal 2 seconds = scrapper floor starts 2 seconds after sensor signal Increase value for dry material!</p>
	<p>Delay time stop automatic loading system</p> <p>Example: 0 seconds = scrapper floor stops immediately after inactive sensor signal 2 seconds = scrapper floor stops 2 seconds after inactive sensor signal Increase value for moist material!</p>

6.2.2.4.3 Scraper floor mode

Switching is carried out via touch or scroll wheel by directly selecting the icons

	Manual settings
	Control in % of the maximum possible scraper floor speed; at 70% overdrive is switched on automatically (if available)

6.2.2.5 Menu: Service Access

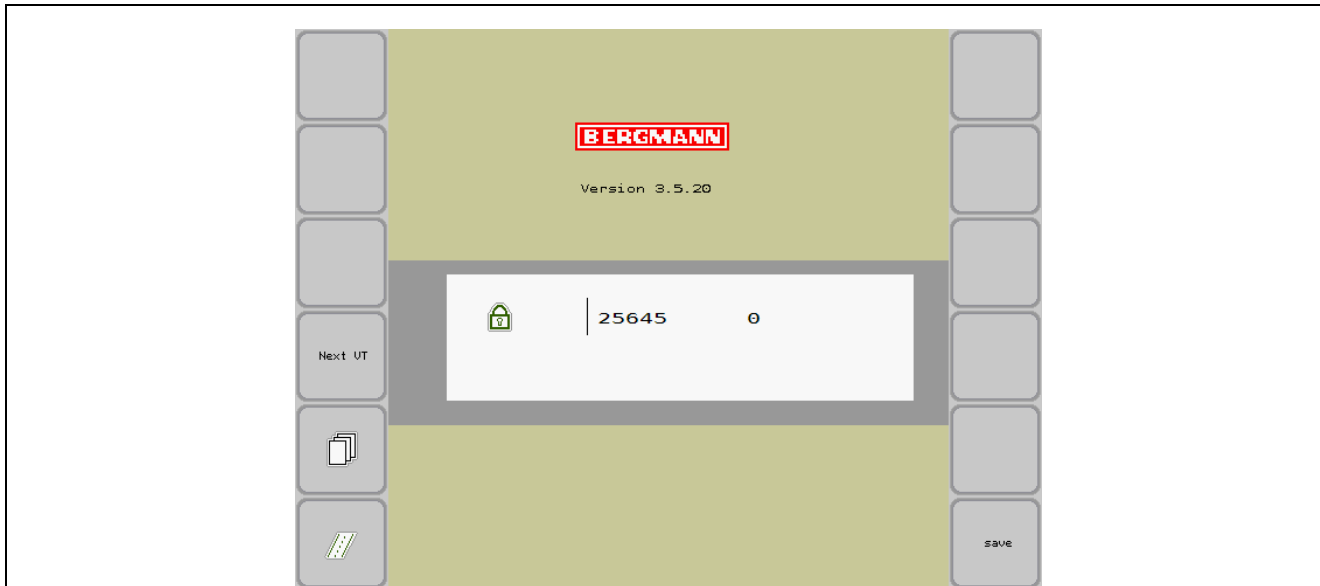

Soft keys

	Change to next ISOBUS terminal, if more are available
	Paging through further functions not possible in this menu
	Change to menu 1/4 "Driving on streets"
	Save entered changes, not necessary here

Data mask

Version 3.5.20	Software version number
25645 0	"22645" random number - please give this number to Bergmann Service
"0"	Select input field for the access code via touch/Poti
! New MType !	Display when connecting a new Bergmann control unit (BSG) or when changing a control unit (BSG) to another machine type, e.g. from spreader to loading trailer and vice versa.
! No MType !	Display when no clearly allocation of the machine type. Also appears if the control unit supply voltage is too low (e.g. below 10 volts)

6.3 Terminal Pilotbox cross conveyor belt

The operation of the hydraulic functions for unloading with cross conveyor belt are carried out via the Pilotbox cross conveyor belt terminal. This terminal has the following elements:

- Terminal ON–OFF
- Scraper floor control and adjustment of the scraper floor speed
- Coupling control (rotor / dosing rollers)
- Cross conveyor belt control.



Image 101: Terminal Pilotbox cross conveyor belt

The terminal can be mounted both in the tractor cab as well as in the lateral tail section of the vehicle as tail control.

	<p>DANGER!</p>
<p>Danger of drawing in or catching of the whole body in the case of driven tools when present in danger area!</p> <p>These dangers can cause severe and potentially fatal injuries.</p> <ul style="list-style-type: none"> When operating the vehicle via the Terminal Pilotbox cross conveyor belt a safety distance of at least 850 mm to movable components of the vehicle must be kept. Keep people out of the tractor and machine danger areas and away from moving vehicle parts! Persons must be permanently in the field of view of the driver. The unloading procedure must be interrupted immediately if visual contact is lost. Stop immediately and immediately stop all drives. 	

	<p>NOTE</p> <ul style="list-style-type: none"> Protect the terminal from water. Store the terminal in a dry room if it is not used for an extended period (e.g. in winter). Disconnect the power supply during installation and repair work. For welding work, remove all electronic components (terminal, control units, etc.). Overvoltage can damage the terminal's electronics.
---	---

6.3.1 User interface of the Pilotbox cross conveyor belt

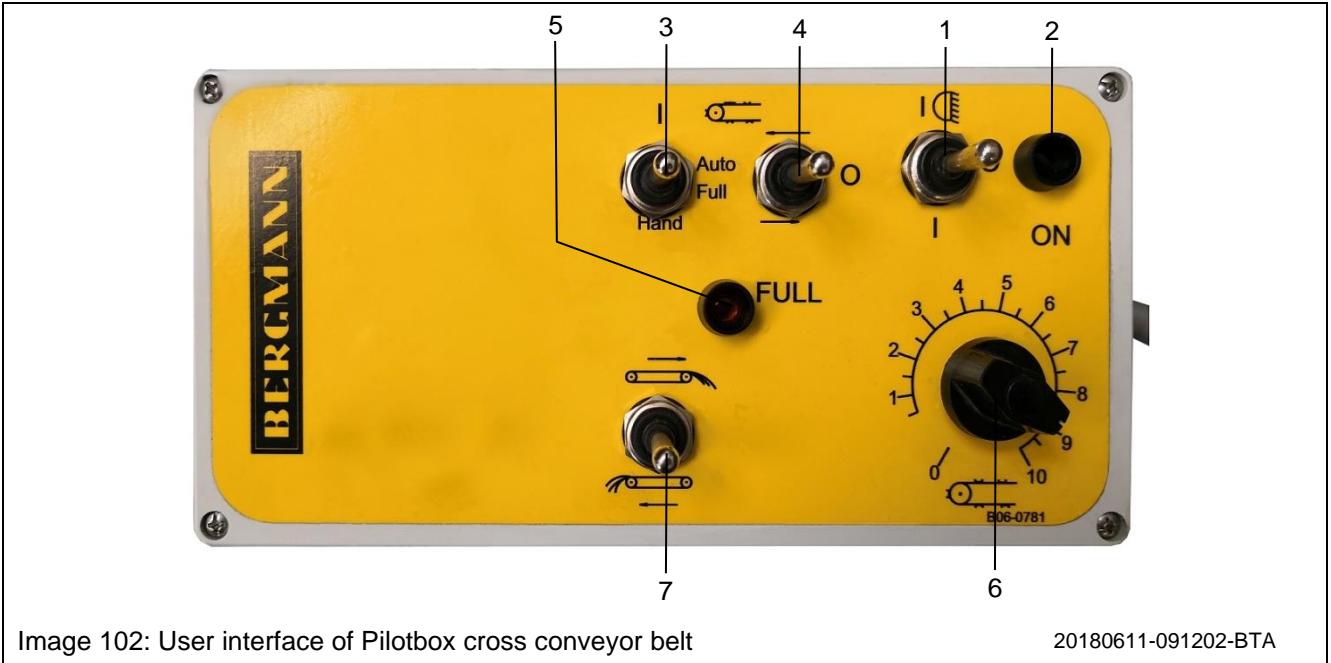
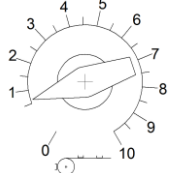
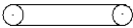
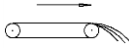

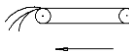

Image 102: User interface of Pilotbox cross conveyor belt

20180611-091202-BTA

1	Main switch			Terminal and lighting on (indicator lamp pos. 2 on)
				Terminal and lighting off (indicator lamp pos. 2 off)
				Terminal on (indicator lamp pos. 2 on)
2	Indicator lamp (ON)			Not lit: Control Off
				Lit: Control On
3	Scrapper floor - main switch			Switch on scrapper floor
			Auto Full	Scrapper floor "Auto full" - operation
			Hand	Scrapper floor "Manual" - operation
4	Scrapper floor conveying direction			Scrapper floor conveys in the direction of the front wall (reversing)
				Scrapper floor off
				Scrapper floor conveys in direction of the rear
5	Indicator lamp (FULL)			Signals "FULL"

6	Scrapper floor speed			<p>Setting the scrapper floor speed</p> <p>Setting value: 0 - 10</p>
7	Cross conveyor belt conveying direction			Switch on cross conveyor belt with conveying direction right
				Switching off the cross conveyor belt
				Switch on cross conveyor belt with conveying direction left

7 Commissioning

Chapter "Commissioning" provides information about the initial start-up as well as any further start-up of the vehicle.

**WARNING!**

Failure to observe the safety instructions may result in serious injury or death.

- In order to prevent accidents, the operator of the vehicle must read and observe the safety instructions in the "Safety" chapter.



**CAUTION!**

Risk of accidents or vehicle damage through incorrect commissioning!

- Have the initial start-up performed only by an authorized specialist.
- Make any adjustment work only with the drive switched off and the engine not running.
- Bring the vehicle to a standstill.
- Switch off the engine, pull the ignition key and take it with you.
- Secure the vehicle and tractor against rolling.

7.1 Securing the vehicle against unintentional rolling and starting

For all work on the vehicle (e.g. maintenance or adjustment), secure the vehicle against unintentional rolling and starting.

	WARNING!
	<p>There is a danger of crushing, shearing, cutting, severing, trapping, entanglement, drawing in, catching and impact for people when reaching into or working on the vehicle.</p> <p>These dangers can arise when</p> <ul style="list-style-type: none"> - the unsecured tractor and the vehicle roll away unintentionally, - driven tools and drives are not switched off, - hydraulic functions are unintentionally performed, - tools or parts of the vehicle are driven, - the tractor's engine is unintentionally started, - raised parts of the vehicle unintentionally lower, <p>These dangers exist during all work on the vehicle through unintentional contact with driven, unsecured tools and drives, which may run on after being switched off, and through raised, unsecured parts of the vehicle.</p> <ul style="list-style-type: none"> • Before any work on the vehicle, such as making adjustments or eliminating faults, the vehicle must be secured against unintentional rolling and starting. <p style="margin-left: 20px;">  Observe the notes and instructions in the vehicle's operating instructions, chapter "Commissioning", section "Securing the vehicle against unintentional rolling and starting". </p>

Observe the following instructions to secure the vehicle against rolling and unintentional starting:

- Position the vehicle on a firm, level ground.
- Secure all movable parts against unintentional lowering by either lowering the parts into a safe end position or securing them with suitable supports or the stopcock.
- Switch the drives off and wait until any parts that are still moving have come to a complete standstill.
- Depressurize the tractor's hydraulic system.
- Switch off the electronic systems.
- Switch off the tractor's engine.
- Pull the ignition key and keep it with you.
- Secure the vehicle and the tractor against rolling with the parking brake and wheel chocks.



For a description of the individual vehicle functions, refer to the instructions and notes in the operating instructions, chapter "Functions and settings".

7.2 After delivery

When you receive your vehicle, do the following:

- Remove all wiring and transportation aids.
 - If the vehicle has come into contact with de-icing salt during transport, it must be thoroughly washed with water to prevent possible corrosion damage.
 - Before start-up, grease all lubrication points.
-

7.3 Adapting to the tractor

To optimize the utilization and safety of your vehicle, it must be matched to the tractor with which it is to be used.



To do this, observe the instructions and notes in the following sections.

	NOTE
	Whenever you change the tractor with which you operate the vehicle, recheck the following points and adapt the vehicle to the new tractor.

7.3.1 Changing the drawbar

When adapting to the tractor and during maintenance of the vehicle, the drawbar may have to be changed.

	NOTE
	Should the new drawbar have a different type approval number than the originals, the vehicle registration may no longer be valid.



The possible drawbars depend on the vehicle type and equipment. For further information, see the notes and instructions in the operating instructions, chapter "Commissioning", sections "Suitability of the tractor" and "Drawbar of the vehicle".

Preparations

- Secure the vehicle against rolling and unintentional starting.



Observe the notes and instructions in the operating instructions, chapter "Commissioning", section "Securing the vehicle against unintentional rolling and starting".

- Correctly uncouple the vehicle from the tractor.



Observe the notes and instructions in the operating instructions, chapter "Commissioning", section "Uncoupling from the tractor".

7.3.1.1 Coupling unit with flange

Change the coupling unit as follows:

- Remove the coupling unit by loosening and removing the bolts.
- Position the new coupling unit over the corresponding holes and fasten it with the lock washers and bolts. If the previously removed bolts are worn, replace with new quality grade 10.9 bolts.



The bolts to be used can be found in the spare parts list. Always use quality grade 10.9 bolts!

- Tighten the screws to the appropriate torque.



Torques to be used can be found in the "Maintenance and Care" chapter in the "Tightening torques" / "Tightening torques for bolts with flanged coupling units" section in the operating manual.

- Lubricate the coupling unit at the lubrication points and on the contact surfaces on the coupling point.

7.3.1.2 Drawbar with shaft

Change the drawbar as follows:



- Remove the drawbar by removing the cotter pin, release the castle nut and remove the drawbar.
- Fit the new drawbar into the drawbar shaft.
- Tighten the castle nut to the specified torque.





For the tightening torques, see the operating instructions, chapter „Care and maintenance“, section „Tightening torques“ / „Tightening torques for castle nuts on drawbars with shaft“.

- Secure the castle nut with the cotter pin.
- Lubricate the drawbar at the lubrication points and at the contact surfaces of the coupling point.

7.3.2 Setting the Pick-up Working Height

	WARNING!
	<p>Danger of injury from moving tractor or vehicle, or from vehicle parts!</p> <ul style="list-style-type: none"> • Before working on the vehicle, secure the tractor and the vehicle against unintentional rolling and starting! • Keep people out of the tractor and vehicle danger areas and away from moving vehicle parts! <p style="margin-left: 20px;">  For this, the notices and instructions in the operating instructions in section "Commissioning" under "Securing vehicle against unintentional rolling and starting" are to be observed. </p>

	WARNING!
	<p>Danger of injury from unintentional pick-up movement!</p> <p>If the pick-up is not secured, it can move when not intended. This can cause severe injury to persons.</p> <ul style="list-style-type: none"> • Always secure the pick-up against unintentional lowering before working on or under the pick-up. • Keep people out of the tractor and vehicle danger areas and away from moving vehicle parts! <p style="margin-left: 20px;">  For this, observe the notices and instructions in the operating instructions in chapter "Functions and Settings" in the Hydraulics" in the "Pick-up / Lock / Unlock Pick-up") sections. </p>

The pick-up working height must be set correctly in order to make optimum use of the pick-ups operating range. This is done by adjusting the height of the guide wheels, which influences the distance between the ground and the pick-up's spring tines.

The distance between the ground and the pick-up's spring tines depends on the stubble height, material being loaded and ground conditions.

Higher setting: For high stubble and extremely uneven ground.

Lower setting: For short green fodder and even ground.

	NOTICE
	<p>To avoid soiling the fodder the tines should never dig into the ground. Set the operating height so that the harvested material is picked up without loss.</p>

When adjusting the pick-up working height, proceed as follows:

- Place the tractor and the empty vehicle on level, firm ground.
- Secure the tractor and vehicle against unintentional rolling and starting.
- Raise the pick-up high enough that there is enough space to adjust the guide wheels (Image 103 / Pos.1).
- Secure the pick-up against unintentional lowering.

- Remove the spring pin (Image 103 / Pos.2) for securing the coupling rod (Image 103 / Pos.3).
- Hold the guide wheel up using the handle (Image 103 / Pos.4) and remove the coupling rod (Image 103 / Pos.3) from the locating pin.
- Adjust the height of the guide wheels as desired and hang the coupling rod (Image 103 / Pos.3) on the locating pin in the respective hole.
- Secure the coupling rod (Image 103 / Pos.3) with the spring pin (Image 103 / Pos.2).

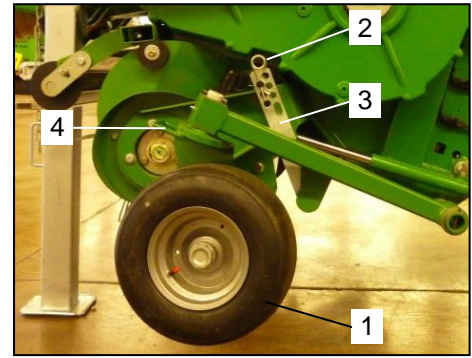

Image 103: Guide Wheels



NOTICE

Ensure that the guide wheels are in the same hole of the coupling rod on both sides and are thus at the same height on both sides.

- Release the safety on the pick-up so that the height can be adjusted.
- Lower the pick-up until the guide wheels are on the ground.
- Then, the pick-up cylinder reference measurement must be checked, (as shown in Image 104) and must be the following size.

Pick-up cylinder reference measurement: 40 - 50 mm

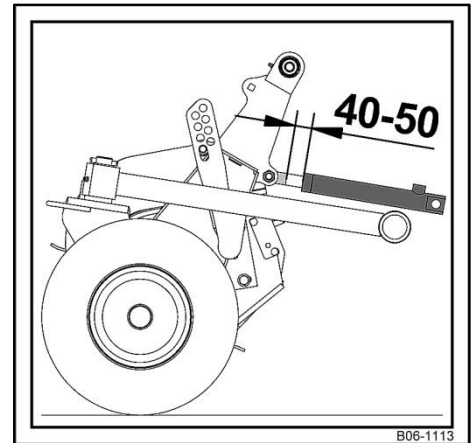

Image 104: Pick-up cylinder

If the pick-up cylinder reference measurement is incorrect, the drawbar cylinder must be adjusted. This must be done as follows:

- Completely retract the drawbar cylinder (Image 105 / Pos.1).
- Loosen lock nuts (Image 105 / Pos.2).
- Adjust the drawbar by alternately turning the left and right piston rods (Image 105 / Pos.3).
- When the correct measurement has been reached, retighten the lock nuts (Image 105 / Pos.2).

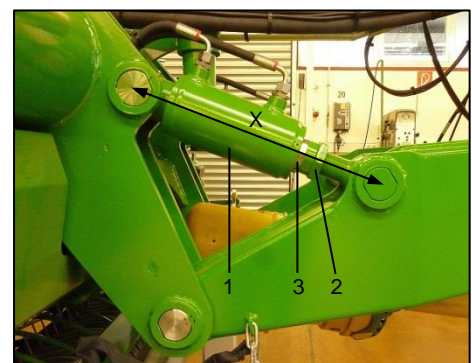

Image 105: Drawbar cylinder

In order to find the value of X, the cylinder must be completely retracted:

- x=370mm (minimum length)
- x=400mm (Standard setting)
- x=430mm (maximum length)

7.3.3 Adapting the drive shaft

The length of the drive shaft must be adapted to the tractor used when taking the vehicle into operation for the first time. Whenever you change the tractor, you must also adapt the shaft again.

The procedure for shortening the drive shaft and the drive shaft guards is described in the following sections.

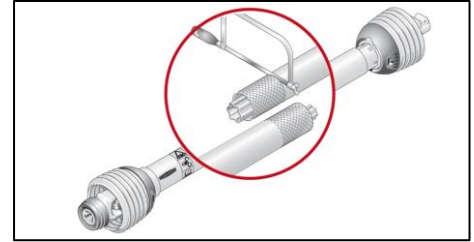

Image 106: Adapting the drive shaft

	WARNING!
	<p>There is a risk of injury through drawing in and catching, as well as from ejected objects when the drive shaft is assembled or connected incorrectly or if unauthorized structural changes are made.</p> <ul style="list-style-type: none"> Only authorized people must make approved structural changes to the drive shaft. The length of the drive shaft must be checked in all operating states, e.g. at full-lock turns to the right and left or when operating the hydraulic drawbar adjuster (if fitted); the drive shaft must not be compressed. If necessary, adjust the drive shaft before coupling it to your tractor for the first time. Changing the length of the drive shaft taking into account the required greatest possible sliding section overlap (see Image 107) is permissible. Not permissible are any structural changes to the drive shaft that are not described in the following sections and in the supplied operating instructions for the drive shaft.



Observe also the notes and instructions in the drive shaft manufacturer's operating instructions.

Greatest possible sliding section overlap

	Drive shaft length, retracted	Drive shaft length in operation
P / W / ECO		
PW / WW		
	<p>LZ = drive shaft length, retracted LB = drive shaft length in operation Pu = sliding section overlap 1/2 PuLZ for shafts <1010 mm, otherwise PuLZ ≥ 300 mm</p>	
	Image 107: Greatest possible sliding section overlap	

7.3.3.1 Shortening the drive shaft

Shorten the drive shaft as described below:

- Couple the vehicle correctly to the tractor without connecting the drive shaft.



Observe the notes and instructions in the operating instructions, chapter “Commissioning”, section “Coupling to the tractor”.

- Secure the vehicle against rolling and unintentional starting.



Observe the notes and instructions in the operating instructions, chapter “Commissioning”, section “Securing the vehicle against unintentional rolling and starting”.

- Carry out the following steps (Image 108).

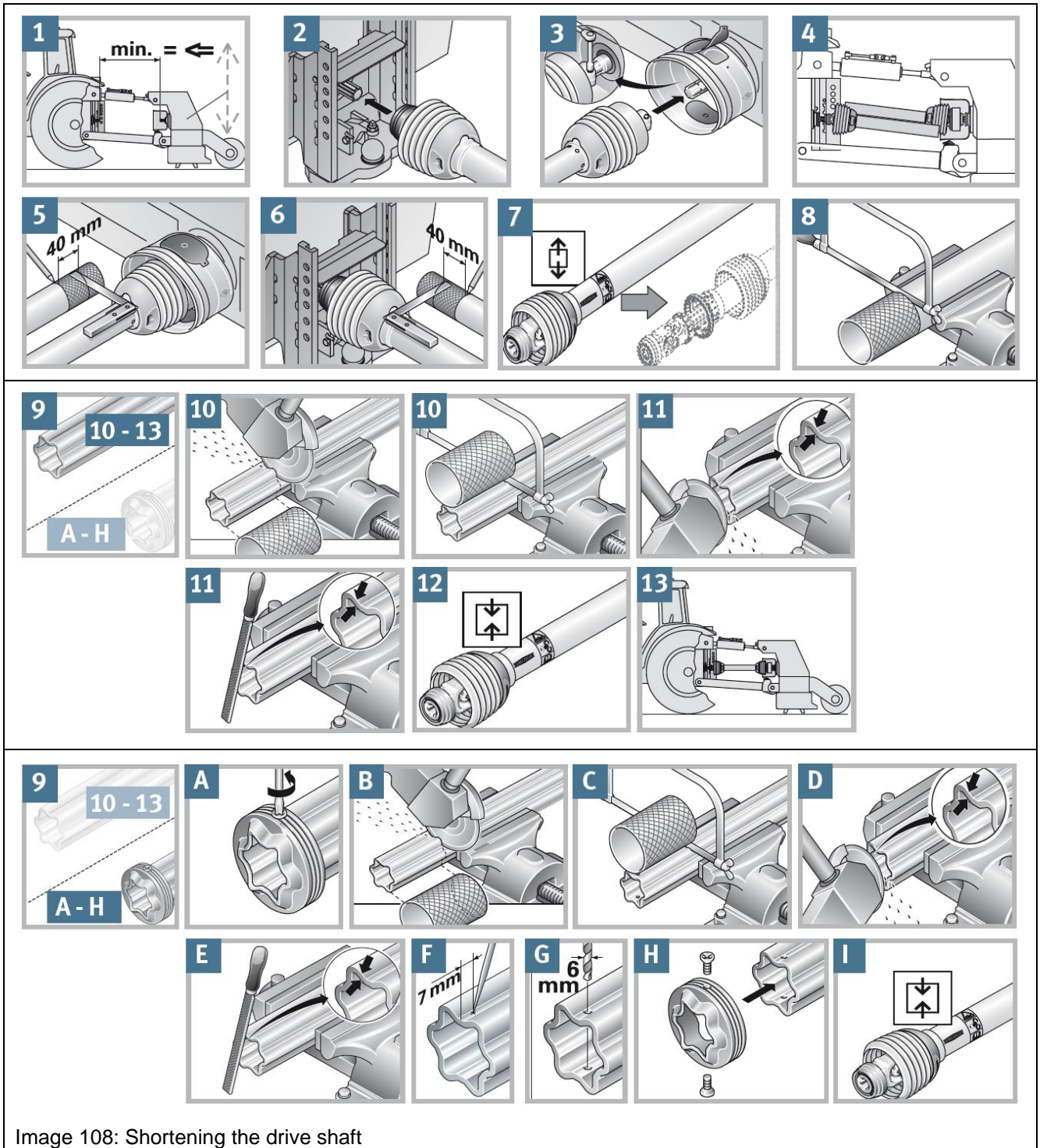

Image 108: Shortening the drive shaft

7.3.3.2 Shortening the drive shaft guard

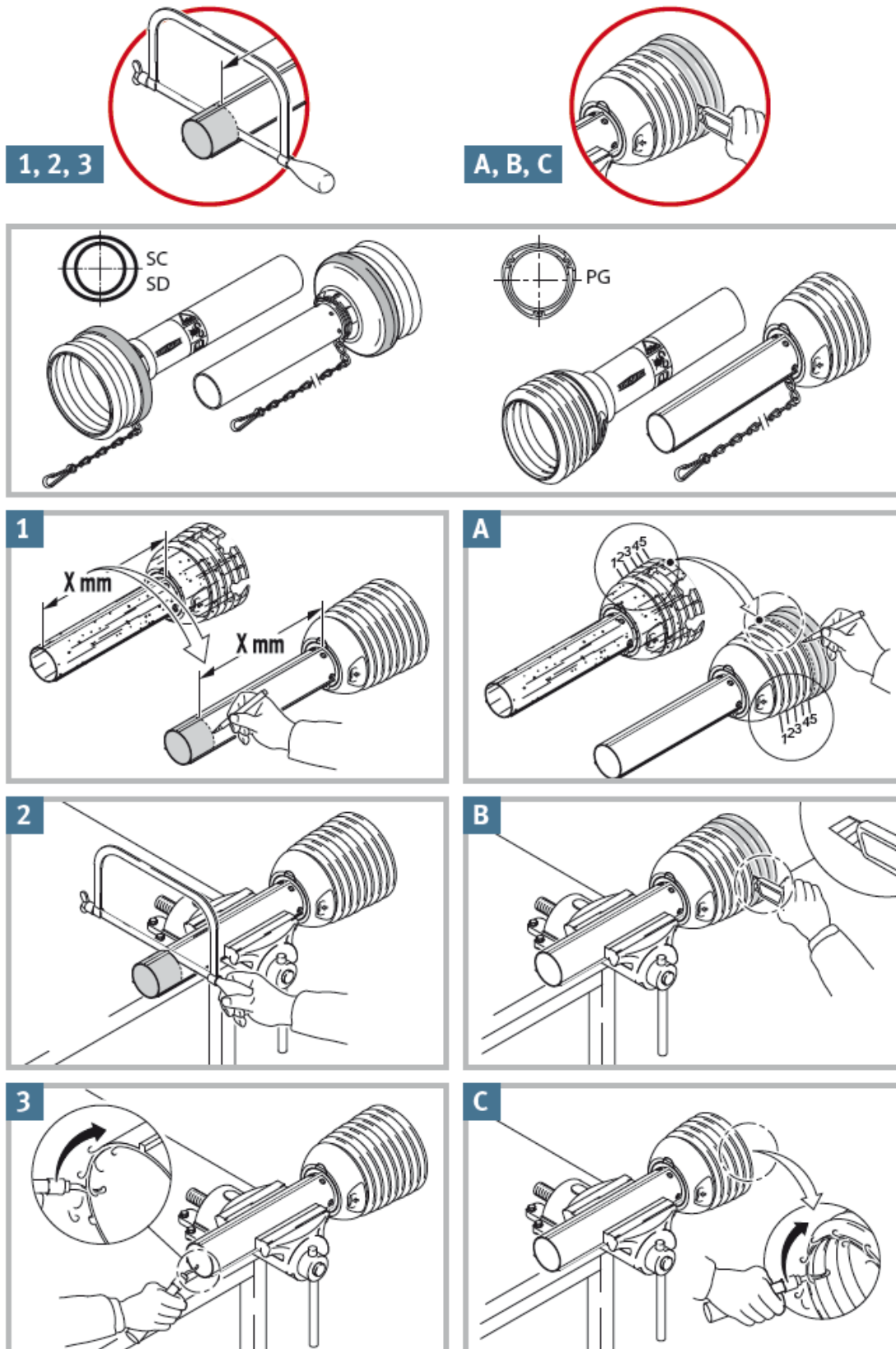

Image 109: Shortening the drive shaft guard

20161012-163007-BTA

7.4 Coupling to the tractor

Section “Coupling to the tractor” provides a brief description of the procedure for coupling the vehicles to a tractor. To do this, read the following sections in order.

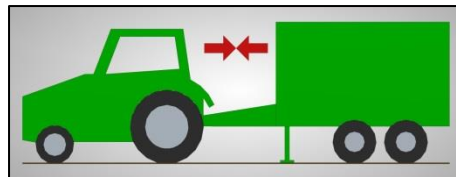

Image 110: Coupling to the tractor



For detailed information about the vehicle elements mentioned in this section, their functions and associated handling, and instructions and notes for safe operation of the vehicle, see chapters “Functions and settings” and “Operation”.



WARNING!

Danger through non-observation of the basic safety instructions.

This can cause serious injuries.



When doing this, always observe the safety instructions in the operating instructions, chapter “Safety”, section “Basic safety instructions”, in particular section “Coupling and uncoupling the vehicle”.



WARNING!

Danger of crushing and impact for people that are between tractor and vehicle when coupling and uncoupling the vehicle.

- There must be no people in the danger area between tractor and vehicle when the tractor is driven towards the vehicle.
- Ground guides must stand only next to the vehicle and move between tractor and vehicle only when the tractor has come to a standstill.



WARNING!

Danger through improper use of the tractor occurs when component failure results in insufficient stability and insufficient steering and braking capability of the tractor.



Observe the notes and instructions in the operating instructions, chapter “Commissioning”, section “Suitability of the tractor”.

7.4.1 Preparations

- Set the coupling on the tractor such that there is sufficient space for the PTO cardan shaft (also when the drawbar bends).
- Drive the tractor up against the vehicle.

7.4.2 Connecting the hydraulics

e-control (operation using terminal)

- Depressurize the control unit on the tractor.
 - Connect the return line (larger cross section).
 - Connect the control block pressure line (E-control).
 - Connect the LS line (if applicable).
-

7.4.3 Connecting the terminal (with E-control)

- Attach the terminal on the tractor.
 - Connect the terminal's 2-pin power cable to the socket on the tractor.
 - Plug the control unit's connection cable into the socket on the vehicle.
-

7.4.4 Coupling the vehicle

- With the control system on the side or the terminal, set the height of the drawbar eye according to the trailer hitch on the tractor.
- Move the tractor up against the vehicle and engage and securely lock the coupling.
- Raise the high-lift drawbar to relieve the jack stand.
- Raise the jack stand, bringing it into driving position.
- Connect the PTO cardan shaft, hydraulic system, brake system and lighting system to the tractor.
- Release the parking brake and place the wheel chocks in the wheel chock holders and secure them.
- Check brake action before operation. In case of brake malfunction, stop operation immediately and have the brakes repaired.

Important Detailed descriptions of the individual functions and the respective instructions and notes can be found the operating instructions in chapter "Commissioning and functions".

7.5 Uncoupling from the tractor

Section “Uncoupling from the tractor” provides a brief description of the procedure for uncoupling the vehicles from a tractor. To do this, read the following sections in order.

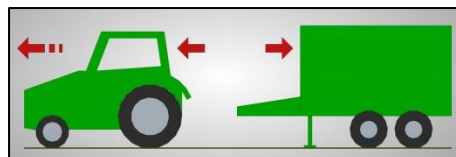







Image 111: Uncoupling from the tractor



For detailed information about the vehicle elements mentioned in this section, their functions and associated handling, and instructions and notes for safe operation of the vehicle, see chapters “Functions and settings” and “Operation”.

	<p>WARNING!</p> <p>Danger through non-observation of the basic safety instructions.</p> <p>This can cause serious injuries.</p>  <p>When doing this, always observe the safety instructions in the operating instructions, chapter “Safety”, section “Basic safety instructions”, in particular section “Coupling and uncoupling the vehicle”.</p>
	<p>WARNING!</p> <p>Danger of crushing and impact for people that are between tractor and vehicle when coupling and uncoupling the vehicle.</p> <ul style="list-style-type: none"> • There must be no people in the danger area between tractor and vehicle when the tractor is driven towards the vehicle. • Ground guides must stand only next to the vehicle and move between tractor and vehicle only when the tractor has come to a standstill.
	<p>WARNING!</p> <p>Danger through improper use of the tractor occurs when component failure results in insufficient stability and insufficient steering and braking capability of the tractor.</p>  <p>Observe the notes and instructions in the operating instructions, chapter “Commissioning”, section “Suitability of the tractor”.</p>





7.5.1 Uncoupling the vehicle

- Place the empty vehicle on a firm, even surface and secure it against rolling (parking brake, wheel wedges).
- Lower the jack stand, bringing it into support position.
- Lower the high-lift drawbar to transfer the weight to the jack stand until the drawbar has no load.
- Depressurize the complete hydraulic system of the vehicle.
- Disconnect the PTO cardan shaft, hydraulic system, brake system and lighting system from the tractor.
- Uncouple the vehicle.

Important! Detailed descriptions of the individual functions and the respective instructions and notes can be found the operating instructions in chapter "Commissioning and functions".

8 Use



Chapter "Use" contains information for operating the vehicle. It describes the handling of the vehicle and the procedure when using it.

	WARNING!
	<p>Failure to observe the safety instructions may result in serious injury or death.</p> <ul style="list-style-type: none"> • In order to prevent accidents, the operator of the vehicle must read and observe the safety instructions in chapter "Safety".
	WARNING!
	<p>There is a danger of crushing, shearing, cutting, severing, trapping, entanglement, drawing in, catching and impact for people when reaching into or working on the vehicle.</p> <p>These dangers can arise when</p> <ul style="list-style-type: none"> - the unsecured tractor and the vehicle roll away unintentionally, - driven tools and drives are not switched off, - hydraulic functions are unintentionally performed, - tools or parts of the vehicle are driven, - the tractor's engine is unintentionally started, - raised parts of the vehicle unintentionally lower, <p>These dangers exist during all work on the vehicle through unintentional contact with driven, unsecured tools and drives, which may run on after being switched off, and through raised, unsecured parts of the vehicle.</p> <ul style="list-style-type: none"> • Before any work on the vehicle, such as making adjustments or eliminating faults, the vehicle must be secured against unintentional rolling and starting. <p> Observe the notes and instructions in the operating instructions, chapter "Commissioning", section "Securing the vehicle against unintentional rolling and starting".</p>
	WARNING!
	<p>Danger of crushing, shearing, cutting, severing, trapping, entanglement, drawing in and catching of body parts when driven drive elements are not protected!</p> <ul style="list-style-type: none"> • Never use the drive shaft without guard, with a damaged guard or without correct use of the safety chain. Immediately have any damaged or missing parts of the drive shaft replaced by original parts from the drive shaft manufacturer. • The unprotected parts of the drive shaft must always be protected by a guard shield on the tractor and a guard cup on the vehicle. • Before each use, check whether all drive shaft guards are fitted and working properly. • Close or fit opened or removed guards before starting vehicle operation. • Immediately replace any missing or faulty guards.

8.1 Before use

The following sections contain important points to be taken into account without fail when preparing your vehicle for use.

8.1.1 General

	NOTE
	<p>The vehicle must be used only after a correctly performed commissioning of the vehicle. This ensures the correct functioning of your vehicle when driving and in operation.</p> <p> Observe the notes and instructions in the operating instructions, chapter "Commissioning".</p>

8.1.2 Setting the follow-up steering

	NOTE
	<p>The steering axle must not be run as follow-up steering; when driving, the steering axle must be locked,</p> <ul style="list-style-type: none"> - when driving on public roads. - when driving on bumpy or otherwise uneven surfaces. - when driving over bunker silos. - when driving on inclines. - if the lateral guide of the rigid axles alone cannot ensure safe vehicle operation. - before reversing.



Observe also the notes and instructions in the operating instructions, chapter "Functions and settings", section "Chassis" / "Follow-up steering".

8.1.3 Setting the brake system

	NOTE
	<p>The drum brake linings require a few hours of operation to adapt to the drum brake. and achieve their full braking performance.</p> <ul style="list-style-type: none"> • Test the function of the brake system before using or towing the vehicle.

Air brake

	NOTE
	<ul style="list-style-type: none"> • Before the first trip of the day, drain the water from the compressed air tank of the air brake. • Before each trip, set the brake effect regulator according to the vehicle's load with the manual adjuster (depends on the vehicle's equipment).

8.1.4 Setting the pick-up working height

The pick-up working height must be set correctly in order to make optimum use of the pick-ups operating range. This is done by adjusting the height of the guide wheels, which influences the distance between the ground and the pick-up's spring tines.



Observe the notes and instructions in the operating instructions, chapter "Commissioning", section "Adapting to the tractor" / "Setting the Pick-Up working height".

8.1.5 Setting the guide comb and swath roller



NOTE

Incorrect setting of the guide comb / swath roller can cause damage to the vehicle. This results in bent or broken Pick-Up tines.

- Make sure that the guide comb and the swath roller do not come in contact with the Pick-Up tines during operation.



Observe also the notes and instructions in the operating instructions, chapter "Functions and settings", section "Pick-Up" / "Guide comb and swath roller".

8.2 Loading



WARNING!

There is a danger of component failure if the vehicle's technical limit values are not observed.

The vehicle's technical limit values must be observed. If they are not observed,

- the vehicle can become damaged,
- accidents can result,
- people can sustain serious injuries or death.

The following limit values are especially important for safety:

- Permissible gross weight
- Maximum axle load
- Maximum payload
- Maximum nose weight
- Maximum total height
- Top speed

The limit values must be maintained. Non-observation of these values invalidates any warranty claims. If the weights are not known, the vehicle must be weighed before being taken on public roads.



Observe also the information in these operating instructions in chapter "Vehicle description", section "Technical data" / "Weights".

The values given in the table may differ depending on the vehicle's equipment. The values in the vehicle's operating licence / registration documents are binding.



NOTE

When loading the vehicle, observe the different specific weights of the various load materials. The higher the weight of the load, the lower is the permissible load volume.



Observe the notes and instructions in the following sections.

8.2.1 Determining payload and permissible load volume



To avoid overloading the vehicle, do the following:

Formulas:

$$\text{Max. permissible load} = \text{Permissible gross weight (kg)} - \text{Net weight (kg)} = \dots \text{ kg}$$

$$\text{Max. permissible load volume} = \frac{\text{Max. permissible load (kg)}}{\text{Specific weight of the load (kg/m}^3\text{)}} = \dots \text{ m}^3$$

The following table lists the specific weights of common load materials.

	NOTE
	<p>For the permissible gross weight and net weight values, see the identification plate of your vehicle.</p> <p> These values are also given in these operating instructions in chapter "Vehicle description", section "Technical data".</p>

	NOTE
	<p>Once you have determined the max. permissible load volume, load the vehicle only up to this load volume.</p>

Products	Density [kg/m ³]	DS content [%]
Grass silage "dry"	Approx. 250	Approx. 40
Grass silage "wet"	Approx. 400	Approx. 30
Maize silage "dry"	Approx. 350	Approx. 35
Maize silage "wet"	Approx. 500	Approx. 28

DS= dry content of the load material

Table 1: Specific weights of the load materials

Note: The values given in the table are guide values and may deviate significantly.

8.2.2 Loading with a Pick-Up Version: Vehicles without auto-load



WARNING!

Danger of component failure when the vehicle is not used for its intended purpose or operated incorrectly.

- Observe the vehicle's permissible drive speed before starting the tractor's PTO.
- In tight bends, switch off the tractor's PTO to avoid overloading the PTO cardan shaft. If the overload clutch engages, stop the PTO and eliminate the cause.
- Raise the Pick-Up only when it no longer contains any load material.
- Raise the Pick-Up at headlands and for taking sharp corners.
- To prevent heavy bottoming of the Pick-Up and resulting damage to the trailing arms, readjust the Pick-Up via the drawbar adjuster on very uneven ground.
- Switch the conveyor unit off only when the conveying channel is empty.



NOTE

When loading the vehicle, observe the following points:

- To obtain a good cut quality when silaging, ensure a strong feed flow.
- The swath should be even and loose.
- Take up load only in the direction of mowing.
- Avoid excessive pressing. Start up the scraper floor on time.
- When loading, adjust your driving speed to the density of the swath and the load.

8.2.2.1 Preparing the loading procedure

- Switch on the terminal.
- On the terminal, select the "Load" menu.
- Start up the tractor's PTO at the specified speed.
- On vehicles without load sensing, switch on the oil supply of the vehicle's control block.
- From the terminal, lower the Pick-Up into working position.
- On vehicles with hydraulically operated front wall lower section:
 - Using the terminal, move the front wall lower and upper sections into position 1 (front wall lower and upper sections fully to the rear towards the cargo space).



For detailed information about the vehicle elements mentioned in this section, their functions and associated handling, and instructions and notes for safe operation of the vehicle, see chapters "Functions and settings" and "Operation".

8.2.2.2 Loading procedure

- Start loading the vehicle. When loading, adjust your driving speed to the density of the swath and the load.
- When the load in the front area of the cargo space reaches a filling height of about 1.2 m, switch on the scraper floor until it has moved the load about 0.5 m towards the rear. Then, depending on the load height in the front area of the scraper floor, briefly run the scraper floor.
- When loading the cargo space, do not exceed the values and weights indicated on the identification plate.
- When the load reaches the dosing rollers (type “S” with dosing unit sensor) or the tailgate (type “K” with tailgate sensor), this is indicated on the terminal. Do not run the scraper floor any more.

	WARNING!
	<p>Danger of component failure when the vehicle is not used for its intended purpose or is operated incorrectly.</p> <p>If you start up the scraper floor again and load is further pressed into the cargo space, there is a risk</p> <ul style="list-style-type: none"> • that the tailgate (type “K”) becomes damaged, • that the dosing rollers (type “S”) get stuck.

- On vehicles without hydraulically operated front wall lower section:
 - The cargo space is now filled and loading must be stopped.
- On vehicles with hydraulically operated front wall lower section:
 - The front wall automatically hinges forward towards the tractor, making additional cargo space available. When this cargo space is filled, loading must be stopped.



If, during loading, the conveyor unit becomes clogged, follow the instructions and observe the notes in the operating instructions in chapter “Use”, section “Loading” / “Clearing conveyor unit blockages”.



For detailed information about the vehicle elements mentioned in this section, their functions and associated handling, and instructions and notes for safe operation of the vehicle, see chapters “Functions and settings” and “Operation”.

8.2.2.3 Completing the loading procedure

- After loading has stopped, let the tractor’s PTO run on until there is no more load in the conveyor unit.
- From the terminal, raise the Pick-Up into driving position (highest position).
- Stop the tractor’s PTO.
- On the terminal, select the “Driving on roads” menu.



For detailed information about the vehicle elements mentioned in this section, their functions and associated handling, and instructions and notes for safe operation of the vehicle, see chapters “Functions and settings” and “Operation”.

8.2.3 Loading with a Pick-Up Version: Vehicles with auto-load



WARNING!

Danger of component failure when the vehicle is not used for its intended purpose or operated incorrectly.

- Observe the vehicle's permissible drive speed before starting the tractor's PTO.
- In tight bends, switch off the tractor's PTO to avoid overloading the PTO cardan shaft. If the overload clutch engages, stop the PTO and eliminate the cause.
- Raise the Pick-Up only when it no longer contains any load material.
- Raise the Pick-Up at headlands and for taking sharp corners.
- To prevent heavy bottoming of the Pick-Up and resulting damage to the trailing arms, readjust the Pick-Up via the drawbar adjuster on very uneven ground.
- Switch the conveyor unit off only when the conveying channel is empty.



NOTE

When loading the vehicle, observe the following points:

- To obtain a good cut quality when silaging, ensure a strong feed flow.
- The swath should be even and loose.
- Take up load only in the direction of mowing.
- Avoid excessive pressing. Start up the scraper floor on time.
- When loading, adjust your driving speed to the density of the swath and the load.

8.2.3.1 Preparing the loading procedure

- Switch on the terminal.
- On the terminal, select the "Load" menu.
- Start up the tractor's PTO at the specified speed.
- On vehicles without load sensing, switch on the oil supply of the vehicle's control block.
- From the terminal, lower the Pick-Up into working position.
- On vehicles with hydraulically operated front wall lower section:
 - Using the terminal, move the front wall lower and upper sections into position 1 (front wall lower and upper sections fully to the rear towards the cargo space).
- Switch on auto-load from the terminal.



For detailed information about the vehicle elements mentioned in this section, their functions and associated handling, and instructions and notes for safe operation of the vehicle, see chapters "Functions and settings" and "Operation".

8.2.3.2 Loading procedure

- Start loading the vehicle. When loading, adjust your driving speed to the density of the swath and the load.
- When the load in the front area of the cargo space reaches a filling height of about 1.2 m, switch on the scraper floor until it has moved the load about 0.5 m towards the rear.
- With the auto-load function, the scraper floor automatically starts up when the cargo space reaches a defined filling height. The movement of the filler hood is registered by a sensor.
- On vehicles with hydraulically operated front wall lower section:
 - In addition, the auto-load function starts up the scraper floor automatically when the cargo space reaches a defined material pressure. This is registered by a sensor through the movement of the middle front wall stakes.
- When the load reaches the dosing rollers (type “S” with dosing unit sensor) or the tailgate (type “K” with tailgate sensor), this is indicated on the terminal. Do not run the scraper floor any more.



WARNING!

Danger of component failure when the vehicle is not used for its intended purpose or is operated incorrectly.

If you start up the scraper floor again and load is further pressed into the cargo space, there is a risk

- that the tailgate (type “K”) becomes damaged,
- that the dosing rollers (type “S”) get stuck.

- On vehicles without hydraulically operated front wall lower section:
 - The cargo space is now filled and loading must be stopped.
- On vehicles with hydraulically operated front wall lower section:
 - The front wall automatically hinges forward towards the tractor, making additional cargo space available. When this cargo space is filled, loading must be stopped.



If, during loading, the conveyor unit becomes clogged, follow the instructions and observe the notes in the operating instructions in chapter “Use”, section “Loading” / “Clearing conveyor unit blockages”.



For detailed information about the vehicle elements mentioned in this section, their functions and associated handling, and instructions and notes for safe operation of the vehicle, see chapters “Functions and settings” and “Operation”.

8.2.3.3 Completing the loading procedure

- After loading has stopped, let the tractor’s PTO run on until there is no more load in the conveyor unit.
- From the terminal, raise the Pick-Up into driving position (highest position).
- Stop the tractor’s PTO.
- On the terminal, select the “Driving on roads” menu.



For detailed information about the vehicle elements mentioned in this section, their functions and associated handling, and instructions and notes for safe operation of the vehicle, see chapters “Functions and settings” and “Operation”.

8.2.4 Clearing conveyor unit blockages

The knife bar can be moved into and out of the conveying channel hydraulically. This allows blockages in the conveyor unit to be conveniently cleared from the driver's seat in the tractor. Do this as follows:

- Using the terminal, raise the vehicle in the front area by moving the drawbar with the hydraulic drawbar adjuster. Run this function until the cylinders of the drawbar adjuster are fully extended.
- From the terminal, lower the Pick-Up all the way.
- Using the terminal, disengage the cutting unit all the way.
- Carefully and at low tractor engine speed, engage the PTO. Gradually increase the PTO speed. The rotor of the conveyor unit conveys the load through the cutting unit into the cargo space without resistance.
- Briefly switch on the scraper floor from the terminal. This reduces the load on the conveyor unit.
- When you have cleared the blockage, fully engage the cutting unit using the terminal.



For detailed information about the vehicle elements mentioned in this section, their functions and associated handling, and instructions and notes for safe operation of the vehicle, see chapters "Functions and settings" and "Operation".

8.3 Unloading



WARNING!

Materials or foreign objects being flung out of the vehicle can present a danger for people in the danger area of the vehicle.

- Before starting up the vehicle, make sure there are no people in the vehicle danger area or near moving vehicle parts.
- When distributing the load near the edge of fields and near roads, make sure that you do not create a hazard for people or objects. Keep a sufficient safety distance.

8.3.1 Unloading without dosing unit (type “K”)



WARNING!

Danger of drawing in or trapping of the entire body when opening or closing the tailgate and on driven tools (such as scraper floor and dosing rollers)!

This can cause severe and potentially fatal injuries.

- Keep people out of the danger area behind the vehicle and away from moving vehicle parts!

8.3.1.1 Preparing the unloading procedure

- Switch on the terminal.
- On the terminal, select the “Unloading” menu.
- On vehicles without load sensing, switch on the oil supply of the vehicle’s control block.
- From the terminal, raise the Pick-Up into driving position (highest position).
- Using the terminal, raise the vehicle in the front area by moving the drawbar with the hydraulic drawbar adjuster.
- On vehicles with steering axle:
 - The steering axle must not be run as follow-up steering; when driving, the steering axle must be locked.



For detailed information about the vehicle elements mentioned in this section, their functions and associated handling, and instructions and notes for safe operation of the vehicle, see chapters “Functions and settings” and “Operation”.

8.3.1.2 Unloading procedure

- Using the terminal, move the tailgate into position 1 (tailgate fully open).
- Using the terminal, start up the scraper floor.
- Drive forward at the unloading speed.
- On vehicles with hydraulically operated front wall lower section:
 - The front wall lower section automatically moves towards the rear after the scraper floor has travelled a certain distance.
- For emptying the residues, increase the scraper floor speed.



For detailed information about the vehicle elements mentioned in this section, their functions and associated handling, and instructions and notes for safe operation of the vehicle, see chapters “Functions and settings” and “Operation”.



8.3.1.3 Completing the unloading procedure

- Using the terminal, switch off the scraper floor.
- Using the terminal, close the tailgate.
- Using the terminal, lower the vehicle in the front area by moving the drawbar with the hydraulic drawbar adjuster to the desired position.
- On the terminal, select the “Driving on roads” menu.



For detailed information about the vehicle elements mentioned in this section, their functions and associated handling, and instructions and notes for safe operation of the vehicle, see chapters “Functions and settings” and “Operation”.

8.3.2 Unloading with dosing unit (type “S”)

	WARNING!
	<p>Danger of drawing in or trapping of the entire body when opening or closing the tailgate and on driven tools (such as scraper floor and dosing rollers)!</p> <p>This can cause severe and potentially fatal injuries.</p> <ul style="list-style-type: none"> • Keep people out of the danger area behind the vehicle and away from moving vehicle parts!
	CAUTION!
	<p>Danger of damage to the vehicle in the area of the dosing unit drive clutch when opening the tailgate when the PTO is running.</p> <p>The dosing roller clutches engage automatically when the tailgate is opened. To prevent damage to the vehicle,</p> <ul style="list-style-type: none"> • first open the tailgate • and switch on the PTO only once the tailgate is open.

8.3.2.1 Preparing the unloading procedure

- Switch on the terminal.
- On the terminal, select the “Unloading” menu.
- On vehicles without load sensing, switch on the oil supply of the vehicle’s control block.
- From the terminal, raise the Pick-Up into driving position (highest position).
- Using the terminal, raise the vehicle in the front area by moving the drawbar with the hydraulic drawbar adjuster.
- On vehicles with steering axle:
 - The steering axle must not be run as follow-up steering; when driving, the steering axle must be locked.



For detailed information about the vehicle elements mentioned in this section, their functions and associated handling, and instructions and notes for safe operation of the vehicle, see chapters “Functions and settings” and “Operation”.

8.3.2.2 Unloading procedure

- Using the terminal, move the tailgate into position 2 (tailgate partly open).
- Start up the tractor's PTO at the specified speed.

	NOTE
	<p>If the overload protection device responds during unloading, the scraper floor can be reversed briefly. Do this as follows:</p> <ul style="list-style-type: none"> • Move the scraper floor towards the front wall by briefly operating the "Reverse scraper floor" function on the terminal. • Start up the tractor's PTO at the specified speed.

- Using the terminal, start up the scraper floor.
- Drive forward at the unloading speed.

	NOTE
	<p>To unload in several stages, first switch off the scraper floor and then the tractor's PTO and therefore the dosing unit drive. This allows trouble-free restarting of the dosing unit.</p>

- On vehicles with hydraulically operated front wall lower section:
 - The front wall lower section automatically moves towards the rear after the scraper floor has travelled a certain distance.
- For emptying the residues, increase the scraper floor speed.



For detailed information about the vehicle elements mentioned in this section, their functions and associated handling, and instructions and notes for safe operation of the vehicle, see chapters "Functions and settings" and "Operation".

8.3.2.3 Completing the unloading procedure

- Using the terminal, switch off the scraper floor.
- Switch off the tractor's PTO and therefore the dosing unit drive.
- Using the terminal, close the tailgate.
- Using the terminal, lower the vehicle in the front area by moving the drawbar with the hydraulic drawbar adjuster to the desired position.
- On the terminal, select the "Driving on roads" menu.

	NOTE
	<p>Changeover of the dosing unit drive to the rotor drive is automatic.</p>



For detailed information about the vehicle elements mentioned in this section, their functions and associated handling, and instructions and notes for safe operation of the vehicle, see chapters "Functions and settings" and "Operation".

8.3.3 Unloading with dosing unit (type “S”) and cross conveyor belt



DANGER!

Danger of drawing in or catching of the whole body in the case of driven tools when present in danger area!

- When operating the vehicle via the Terminal Pilotbox cross conveyor belt a safety distance of at least 850 mm to movable components of the vehicle must be kept.
- Keep people out of the tractor and machine danger areas and away from moving vehicle parts!
- Persons must be permanently in the field of view of the driver. The unloading procedure must be interrupted immediately if visual contact is lost. Stop immediately and immediately stop all drives.



CAUTION!

Danger of damage to the vehicle in the area of the dosing unit drive clutch when opening the tailgate when the PTO is running.

The dosing roller clutches engage automatically when the tailgate is opened. To prevent damage to the vehicle,

- First activate the “Open tailgate” function to start the dosing rollers.
- Only switch on the PTO shaft once the “Tailgate open” function has been activated.

8.3.3.1 Preparing the unloading procedure

- Switch on the main terminal.
- On the main terminal, select the “Unloading” menu.
- Switch on the “Pilotbox cross conveyor belt” terminal.
- On vehicles without load sensing, switch on the oil supply of the vehicle’s control block.
- From the main terminal, raise the pick-up into driving position (highest position).
- Using the main terminal, raise the vehicle in the front area by moving the drawbar with the hydraulic drawbar adjuster.
- On vehicles with steering axle:
 - The steering axle must not be run as follow-up steering; when driving, the steering axle must be locked.
- Check whether the tailgate is locked via shut-off valve.



For detailed information about the vehicle elements mentioned in this section, their functions and associated handling, and instructions and notes for safe operation of the vehicle, see chapters “Functions and settings” and “Operation”.

8.3.3.2 Unloading procedure

- Using the terminal, start up the cross conveyor belt.
- At the main terminal, activate the “Open tailgate” function to start up the dosing rollers.
- Start up the tractor’s PTO shaft at the specified speed.

	NOTE
	<p>If the overload protection device responds during unloading, the scraper floor can be reversed briefly. Do this as follows:</p> <ul style="list-style-type: none"> • Move the scraper floor towards the front wall by briefly operating the “Reverse scraper floor” function on the terminal. • Start up the tractor’s PTO shaft at the specified speed.

- Using the terminal, start up the scraper floor.
- Drive forward at the unloading speed.

	NOTE
	<p>To unload in several stages, first switch off the scraper floor and then the tractor’s PTO shaft and therefore the dosing unit drive. This allows trouble-free restarting of the dosing unit.</p>

- For emptying the residues, increase the scraper floor speed.



For detailed information about the vehicle elements mentioned in this section, their functions and associated handling, and instructions and notes for safe operation of the vehicle, see chapters “Functions and settings” and “Operation”.

8.3.3.3 Completing the unloading procedure

- Using the terminal, switch off the scraper floor.
- Stop the tractor’s PTO shaft.
- At the main terminal, stop the dosing rollers by activating the “Close tailgate” function.
- Using the terminal, switch off the cross conveyor belt.
- Using the terminal, switch off the “Pilotbox cross conveyor belt”.
- Using the main terminal, lower the vehicle in the front area by moving the drawbar with the hydraulic drawbar adjuster to the desired position.
- On the main terminal, select the “Driving on roads” menu.



For detailed information about the vehicle elements mentioned in this section, their functions and associated handling, and instructions and notes for safe operation of the vehicle, see chapters “Functions and settings” and “Operation”.

8.3.4 Removing blockages in the dosing unit

If the overload protection device responds during unloading, the scraper floor can be reversed briefly.



Observe also the notes and instructions in the operating instructions, chapter “Functions and settings”, section “Scraper floor” / “Reversing scraper floor”.

8.4 Driving on roads

Important

When doing this, always observe the "General safety and accident prevention regulations" in chapter "Notes for the user".



When driving on public roads, observe the national road traffic regulations.

Before driving on public roads, do the following:

- Make sure that the lighting equipment is properly fitted and connected to the tractor. Check lights for damage, correct function and soiling.
- Check the brakes. In case of brake malfunction, stop the tractor immediately and rectify the fault.
- Make sure that the supply lines are connected correctly.
- Ensure that it is not possible to accidentally operate the hydraulic functions.
- Fully release the parking brake.
- Make sure that all guards are properly mounted and locked.
- The "Driving on roads" menu must be selected for machines with an operator terminal.

8.4.1 Moving vehicle parts to driving position

Before driving, all vehicle parts must be moved to driving position and secured. This includes but is not limited to the following components and functions (depending on vehicle type and equipment):

- The tailgate must be folded down all the way.
- The jack stand must be fully raised.
- The cutting unit must be fully engaged.
- The pick-up must be fully raised.
- If applicable, lock the steering axle (see the following section)
- The chassis with hydraulic axle balance must be set so that the maximum height of 4.00 metres is not exceeded.

8.4.2 Locking the steering axle

To increase the stability of vehicles without forced steering when driving, the follow-up steering axle must be locked

- when driving on public roads
- when driving on bumpy or otherwise uneven surfaces
- when driving over bunker silos
- when driving on slopes
- if the lateral guide of the rigid axles alone cannot ensure safe vehicle operation
- when reversing

For tight cornering, it may be necessary to briefly unlock the steering axle.

8.4.3 Driving style

The vehicle must be under control at all times. Adapt your driving style accordingly. This includes consideration of the driver's skills along with prevailing conditions such as the road surface, curves, traffic, weather and visibility. Choose a driving speed that is appropriate for the prevailing conditions.

If the vehicle is only partially loaded, tractor manoeuvrability could be impaired. In this case, drive with extreme caution. When the vehicle is coupled, ensure that the steering on the front tractor axle is not impaired by observing the nose weight.

During cornering, observe the changed driving behaviour and move the vehicle with special care. Never drive through tight bends at high speed. Avoid sudden cornering when driving on a slope. Danger of tipping!

9 Care and maintenance

Chapter "Care and maintenance" provides information about maintaining the vehicle. It describes the handling and procedures during maintenance and care of the vehicle. Regular and correct maintenance and care ensure a long service life, reliable operation and correct function of the vehicle. They also help reduce downtimes and the need for repairs.

The components and vehicle functions listed in the operating instructions may differ from the vehicle standard equipment and are available as optional features in some cases. Since these operating instructions are general, various equipment options can be listed that are not available for your vehicle. This also applies to illustrations. Images, drawings and 3D illustrations in these operating instructions do not always represent the exact vehicle type. However, the information which refers to the illustrations always corresponds to the vehicle type in this document.



WARNING!

Failure to observe the safety instructions may result in serious injury or death.

- In order to prevent accidents, the operator of the vehicle must read and observe the safety instructions in chapter "Safety".



WARNING!

There is a danger of crushing, shearing, cutting, severing, trapping, entanglement, drawing in, catching and impact for people when reaching into or working on the vehicle.

These dangers can arise when

- the unsecured tractor and the vehicle roll away unintentionally,
- driven tools and drives are not switched off,
- hydraulic functions are unintentionally performed,
- tools or parts of the vehicle are driven,
- the tractor's engine is unintentionally started,
- raised parts of the vehicle unintentionally lower,

These dangers exist during all work on the vehicle through unintentional contact with driven, unsecured tools and drives, which may run on after being switched off, and through raised, unsecured parts of the vehicle.

- Before any work on the vehicle, such as making adjustments or eliminating faults, the vehicle must be secured against unintentional rolling and starting.



Observe the notes and instructions in the operating instructions, chapter "Commissioning", section "Securing the vehicle against unintentional rolling and starting".

9.1 Cleaning and maintenance work in the cargo space



DANGER!

Danger of drawing in or catching of the whole body on driven tools.

These dangers can cause severe and potentially fatal injuries.

Never step onto the cargo space when the drive is switched on and the engine is running.

- Always switch off all drives, stop the engine and remove the ignition key before working in the cargo space.
- Before performing any work on the vehicle, secure the tractor and the vehicle against unintentional rolling and starting!
- Keep people out of the tractor and vehicle danger areas and away from moving vehicle parts!



Observe the notes and instructions in the operating instructions, chapter "Commissioning", section "Securing the vehicle against unintentional rolling and starting".

9.1.1 Cargo space access

Vehicles with dosing rollers:

The lateral access ladder with access door has to be used when working in the cargo space (e.g. for maintenance or repair work).



Also observe the notes and instructions in the operating instructions, chapter "Functions and settings", section "Access ladder with access door".

Vehicles without dosing rollers:

Entry via the opened tailgate is possible when work inside the cargo space (e.g. maintenance or repair work) is required.



Observe also the notes and instructions in the operating instructions, chapter "Functions and settings", section "Tailgate".

9.2 Maintenance schedule



WARNING!

Danger of component failure when the vehicle is not maintained correctly.

- An improperly maintained vehicle must not be taken into operation.



NOTE

Observe the following points:

- The time intervals, mileage and maintenance intervals listed in the supplied third-party documents have priority and must be observed.
- The maintenance intervals assume normal working conditions. Under harsher working conditions, especially for the brakes, maintenance and/or repair intervals must be shortened.
- Lubricate as specified in the lubrication schedule.



Observe the notes and instructions in the operating instructions, chapter "Care and maintenance", section "Lubrication".

First use

- Check the following screw connections for tightness:
 - Wheel nuts
 - Drawbar
 - Drawbar eye
 - Chassis
 - Spreader unit / dosing unit
 - Conveyor unit
- Check the hydraulic system for leaks
- Check the oil level of all gearboxes
- Apply grease at all lubrication points
- Check the tyre pressure

After the first runs under load conditions:

- Retighten the wheel nuts.
- Check wheel hub bearings for play and retighten if necessary
- Adjust brakes
- Check steering axle setting (if applicable)
- Retighten the hydraulic connections

After the first 50 trips:

- Check the wheel hub bearing play and set, if necessary.

After 20 trips (daily)

- Lubricate according to the lubrication schedule
- Check function of lighting
- Check function of brake system
- Check the scraper floor tension and adjust tension or shorten chains as necessary
- Check the chain tension in the spreader drive / dosing unit drive
- Lubricate the roller chains (if fitted)
- Drain water from compressed air tank
- Visually check the following vehicle components for damage and defects, including, such as,
 - Check the lubrication lines
 - Check the gearbox
 - Check the U-joints
 - Check the spreader unit / dosing unitand immediately rectify any defects.

Every 100 trips

- Perform all work as specified under "All 20 drives".
- Check and, if necessary, correct the brake settings.
- Check the status of the dosing roller bearings (if fitted)
- Check the condition and fastening of scraper floor bars
- If applicable, check wear plates and replace other wear parts

Every 500 trips:

- Perform all work as specified under "All 100 drives".
- Check brake setting and adjust if necessary
- Check all cables for damage
- Check brake lining thickness. At a minimum brake lining thickness of 5 mm (riveted brake linings) or 2 mm (adhesive bonded brake linings), the pads must be renewed.
- Check play in wheel hub bearings
- Check drawbar eye for wear and proper mounting
- Check all bearings
- Check all screw connections for tightness
- Check vehicle for cracks
- Check brake system for leaks

Every 1000 trips (at least once a year):

- Change grease in the wheel hub bearing and check the taper roller bearings for wear.

9.3 Screw tightening torques

Thread	M 6	M 8	M 10	M 12	M 14	M 16	M 18	M 20	M 22	M 24	M 27	M 30
Wrench size	10	13	17	19	22	24	27	30	32	36	41	46
Tap hole	5	6,8	8,5	10,2	12	14	15,5	17,5	19,5	21	24	26,5
Thread condition	dry*	lubricated**	dry*	lubricated**	dry*	lubricated**	dry*	lubricated**	dry*	lubricated**	dry*	lubricated**
	lubricated**	dry*	lubricated**	dry*	lubricated**	dry*	lubricated**	dry*	lubricated**	dry*	lubricated**	dry*
Torque m (Nm) with	11	22	54	73	148	180	329	464	634	798	1176	1597
Screws of the following strength class	16	32	79	108	172	264	469	661	904	1136	1674	2274
	19	37	93	126	201	309	549	773	1057	1329	1959	2662
												2077

* dry – galvanized or normal thread w/o lubrication

** lubricated – thread is lubricated (e.g. with oil or has been phosphate treated)

Strength classes:

- The bolt's strength class is found on the top of the head (e.g. 8.8, 10.9, 12.9 etc.)
- A hex nut's strength class is found on its face
- A high strength classification shows that a fastened bolt can withstand high amounts of tension

If other torque values are used in these instructions, the table values are void. Regularly inspect nuts and bolts for tightness. If bolts or nuts are replaced, the equivalent or a higher strength class must be used. If a higher strength class is used, the torque should coincide with the original strength class that was used before.

Shear bolts may only be replaced with bolts that have the same dimensions and strength class. When assembling, ensure that the thread is clean and undamaged. Tighten self-locking nuts in accordance with table values for dry bolts.

Table: Default tightening torques for screws

9.4 Cleaning the vehicle

To ensure correct maintenance and ease of operation, regularly and thoroughly clean the vehicle. Cleaning the vehicle after use and subsequent lubrication ensure that the vehicle is ready for use again immediately and prevents drying and hardening of the load.



Observe also the notes and instructions in the operating instructions, chapter “Care and maintenance”, section “Lubrication” / “Lubrication schedule”.

	WARNING!
	<p>Risk of injury through movements of tractor and vehicle or of vehicle parts!</p> <ul style="list-style-type: none"> • Before performing any work on the vehicle, secure the tractor and the vehicle against unintentional rolling and starting! • Keep people out of the tractor and vehicle danger areas and away from moving vehicle parts! <p> Observe the notes and instructions in the operating instructions, chapter “Commissioning”, section “Securing the vehicle against unintentional rolling and starting”. </p>

	WARNING!
	<p>Risk of injury through unintentional movement of components!</p> <p>If raised components are not secured, they can move inadvertently. This can cause serious injuries.</p> <ul style="list-style-type: none"> • Always secure raised components against unintentional lowering or operating before working on or under them. • Keep people out of the vehicle’s danger area and away from moving vehicle parts!

9.4.1 Cleaning the vehicle with a high-pressure cleaner

When using a high-pressure cleaner, observe the following points:

- Use a high-pressure cleaner no earlier than 8 weeks after delivery (to allow the paint to fully cure).
- Minimum nozzle distance 50 cm
- Maximum pressure 50 bars
- Max. water temperature 50 °C
- Spray jet angle 25°
- Do not use cleaning agents
- Do not direct the water jet at seals on bearings, gear units and hydraulic components
- Do not direct the water jet at electrical components, such as terminals, terminal boxes, load cells and sensors.

	NOTE
	<p>After cleaning, observe the following points:</p> <ul style="list-style-type: none"> • Thoroughly lubricate all bearings. Pay special attention to areas that are not specifically mentioned in the lubrication schedule, such as hinges or pivot points, which must be lubricated separately. • Check the vehicle for corrosion damage. Avoid corrosion damage by repairing paint damage on time.

9.5 Conveyor unit



WARNING!

Risk of injury through movements of tractor and vehicle or of vehicle parts!

- Before performing any work on the vehicle, secure the tractor and the vehicle against unintentional rolling and starting!
- Keep people out of the tractor and vehicle danger areas and away from moving vehicle parts!



Observe the notes and instructions in the operating instructions, chapter "Commissioning", section "Securing the vehicle against unintentional rolling and starting".

9.5.1 Rotor

- After every season, check the tine segments (Image 112 / pos. 1) of the rotors.
- Worn tines segments (Image 112 / pos. 1) must be replaced.



Spare parts for your vehicle are contained in the spare parts list. This is included on the supplied operating instructions and spare parts list CD.

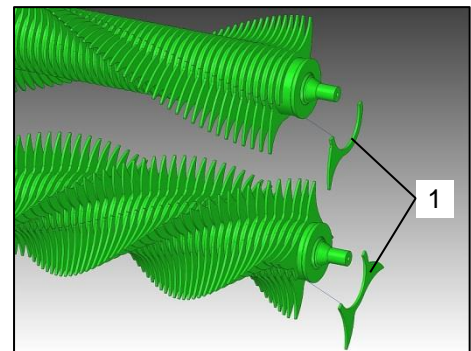

Image 112: Rotors



NOTE

Tine segments must be replaced by a specialist garage or the customer service of LUDWIG BERGMANN GMBH.

9.5.2 Scraper

- After every season, check the scrapers (Image 113 / pos. 2) for wear.
- Worn scrapers (Image 113 / pos. 2) must be replaced.



Spare parts for your vehicle are contained in the spare parts list. This is included on the supplied operating instructions and spare parts list CD.

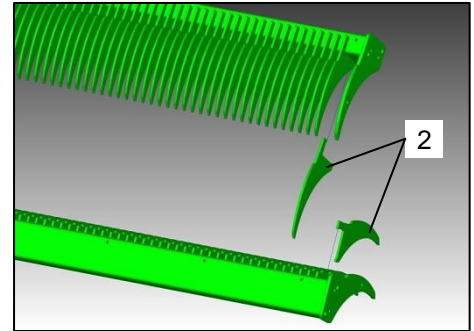

Image 113: Scraper



NOTE

Tine segments must be replaced by a specialist garage or the customer service of LUDWIG BERGMANN GMBH.

9.6 Cutting unit



WARNING!

Risk of injury through movements of tractor and vehicle or of vehicle parts!

- Before performing any work on the vehicle, secure the tractor and the vehicle against unintentional rolling and starting!
- Keep people out of the tractor and vehicle danger areas and away from moving vehicle parts!



Observe also the notes and instructions in the operating instructions, chapter "Commissioning", section "Securing the vehicle against unintentional rolling and starting".



NOTE

Clean the cutting unit with compressed air every day. If the cutting unit is not cleaned correctly, the response threshold of the foreign object protection mechanism will deteriorate.



Observe the notes and instructions in the operating instructions, chapter "Care and maintenance", section "Cutting unit" / "Cleaning the cutting unit".



NOTE

Always ensure that the knives are in a good, sharpened condition. This will allow trouble-free working without undue strain on the material. This reduces conveyor wear and increases the service life.



Observe the notes and instructions in the operating instructions, chapter "Care and maintenance", section "Sharpening knives".

9.6.1 Cutting unit sensor

The cutting unit is fitted with sensors.



Observe the notes and instructions in the operating instructions, chapter "Functions and settings", section "Electrical system".

9.6.2 Cleaning the cutting unit

	CAUTION!
	<p>Danger of flung load residues and dirt particles when cleaning the cutting unit with compressed air.</p> <p>All persons in the vehicle's operating range must wear the following personal protective equipment:</p> <ul style="list-style-type: none"> - Wear eye protection! - Wear hand protection!

	NOTE
	<p>Clean the cutting unit with compressed air every day. If the cutting unit is not cleaned correctly, the response threshold of the foreign object protection mechanism will deteriorate.</p>

Clean the cutting unit (Image 114 / pos. 1) as follows:

- Remove the cover (Image 114 / pos. 2) of the cutting unit (Image 114 / pos. 1).
- Remove load residues from the rear area of the cutting unit (Image 114 / pos. 3). Observe especially
 - the spaces between the springs.
- Fully disengage the cutting unit (Image 114 / pos. 1) using the control system on the vehicle.

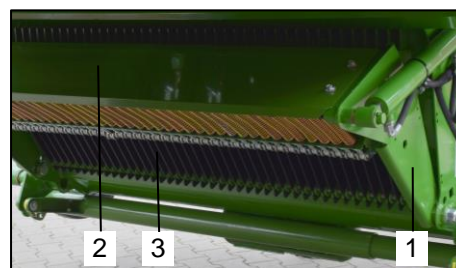

Image 114: Cleaning the cutting unit 1

- Clean the cutting unit with compressed air and remove all load residues. Observe especially
 - the spaces between the knives (Image 115 / pos. 1),
 - the spaces between knife holders (Image 115 / pos. 2),
 - the area of the knife guide (Image 115 / pos. 3).

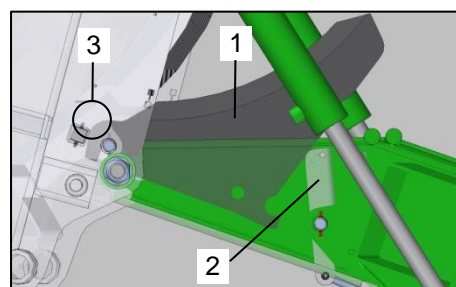

Image 115: Cleaning the cutting unit 2

- Check the cutting unit.



Observe also the notes and instructions in the operating instructions, chapter "Care and maintenance", section "Cutting unit" / "Checking the cutting unit".

- Fully engage the cutting unit (Image 114 / pos. 1) using the control system on the vehicle.
- Fit the cover (Image 114 / pos. 2) of the cutting unit (Image 114 / pos. 1).



For detailed information about the vehicle elements mentioned in this section, their functions and associated handling, and instructions and notes for safe operation of the vehicle, see chapters "Functions and settings" and "Operation".

9.6.3 Checking the cutting unit

When cleaning the cutting unit and changing the knives, check cutting unit for correct function and wear. Carry out the steps described in the following sections.

Preparations



CAUTION!

Danger of cuts on sharp knives when touching the blades.

All persons in the vehicle's operating range must wear the following personal protective equipment:

- Wear hand protection!

- Using the terminal or the control system on the vehicle, fully disengage the cutting unit (Image 116 / pos. 1).



Observe also the notes and instructions in the operating instructions, chapter "Care and maintenance", section "Cutting unit" / "Removing and fitting knives".

- Take out the knives (Image 116 / pos. 2).

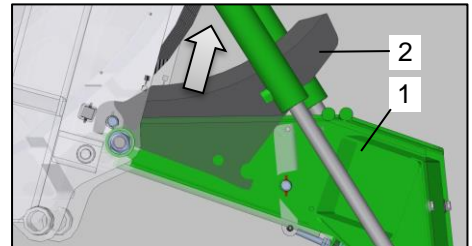

Image 116: Preparations



Observe also the notes and instructions in the operating instructions, chapter "Care and maintenance", section "Cutting unit" / "Removing and fitting knives".

Checking the knife protection mechanism

Do this as follows:

- Check the knife protection mechanism. The guide rollers of the knife protection mechanism (Image 117 / pos. 1) must run freely.
- Release any jammed guide rollers (pos. 3) with multigrip pliers.
- Oil the guide rollers (Image 117 / pos. 1).

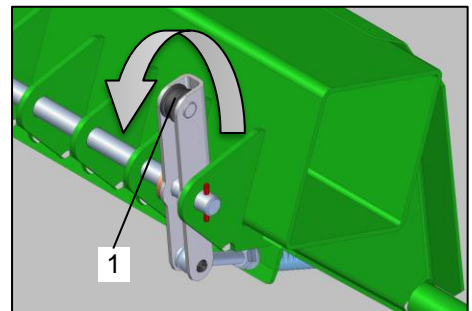

Image 117: Knife protection mechanism

Checking the knife holder

Check the shaft for the knife holder (Image 118 / pos. 1) for wear. If the shaft (Image 118 / pos. 1) is deformed or severely worn, replace it. Do this as follows:

- Remove the cotter pins (Image 118 / pos. 2) on both sides of the shaft (Image 118 / pos. 1).
- Place, for example, a pin punch through the mounting hole (Image 118 / pos. 3) in the frame and drive the shaft (Image 118 / pos. 1) out to the other side.
- Take out the shaft (Image 118 / pos. 1).
- Fit the new shaft in the mounting hole (Image 118 / pos. 3) and drive it into the original position.
- Secure the shaft (Image 118 / pos. 1) on both sides with a cotter pin (Image 118 / pos. 2).

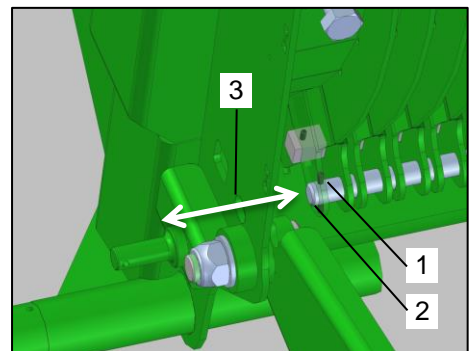

Image 118: Knife holder

Checking the knife guide

Check the block / plate for the knife guide (Image 119 / pos. 1) for wear. If the block / plate (Image 119 / pos. 1) is deformed or severely worn, replace it. Do this as follows:

- Knife guide with block:
 - Remove the cotter pins (Image 119 / pos. 2) on either side of the block (Image 119 / pos. 1).
- Knife guide with plate:
 - Release and remove the locking screws on either side of the plate.
- Place, for example, a pin punch through the mounting hole (Image 119 / pos. 3) in the frame and drive the block/plate (Image 119 / pos.1) out to the other side.
- Remove the block / plate (Image 119 / pos. 1).
- Fit the new block / plate in the mounting hole (Image 119 / pos. 3) and drive it into the original position.
- Knife guide with block:
 - Secure the block (Image 119 / pos. 1) with a cotter pin (Image 119 / pos. 2) on either side.
- Knife guide with plate:
 - Secure the plate on either side with the locking screws. Firmly tighten the nuts.

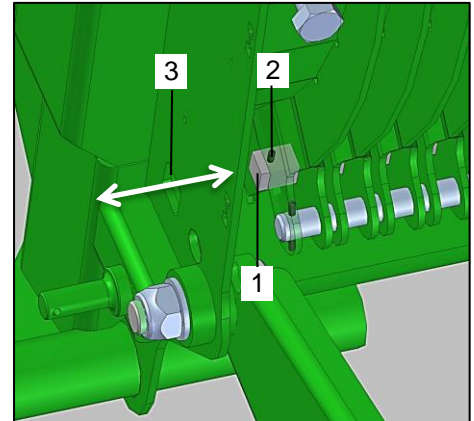

Image 119: Knife guide

Completing the inspection



CAUTION!

Danger of cuts on sharp knives when touching the blades.

All persons in the vehicle's operating range must wear the following personal protective equipment:
- Wear hand protection!

- Refit the knife (Image 120 / pos. 2).
-  Observe also the notes and instructions in the operating instructions, chapter "Care and maintenance", section "Cutting unit" / "Removing and fitting knives".
- Fully engage the cutting unit (Image 120 / pos. 1) using the control system on the vehicle.

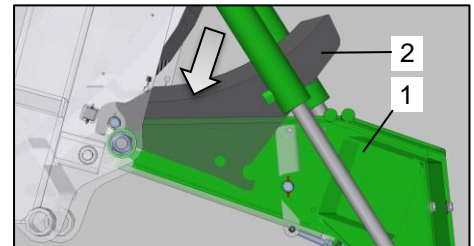

Image 120: Completing the inspection



Observe also the notes and instructions in the operating instructions, chapter "Care and maintenance", section "Cutting unit" / "Removing and fitting knives".

9.6.4 Removing and fitting knives



CAUTION!

Danger of cuts on sharp knives when touching the blades.

All persons in the vehicle's operating range must wear the following personal protective equipment:

- Wear hand protection!

9.6.4.1 Removing knives

Do this as follows:

- Fully disengage the cutting unit (Image 121 / pos. 1) using the control system on the vehicle.
- Take out the knife (Image 121 / pos. 2).
- Check the cutting unit.



Observe also the notes and instructions in the operating instructions, chapter "Care and maintenance", section "Cutting unit" / "Checking the cutting unit".

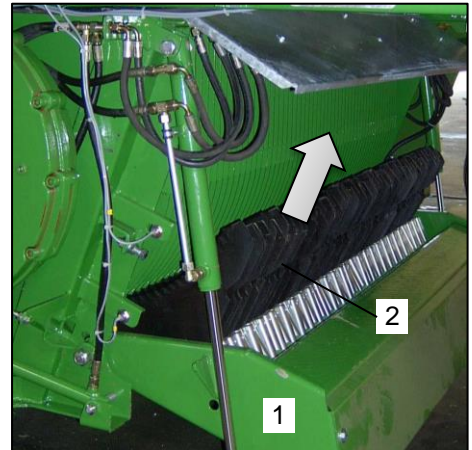

Image 121: Removing knives



For detailed information about the vehicle elements mentioned in this section, their functions and associated handling, and instructions and notes for safe operation of the vehicle, see chapters "Functions and settings" and "Operation".

9.6.4.2 Fitting knives

Do this as follows:

- Place the knife (Image 122 / pos. 1) into the groove of the guide roller at mounting point A (Image 122).
- Engage the knife (Image 122 / pos. 1) into the slit in the cutting tub at mounting point B (Image 122).
- Thread the knife (Image 122 / pos. 1) over the shaft at mounting point B (Image 122).

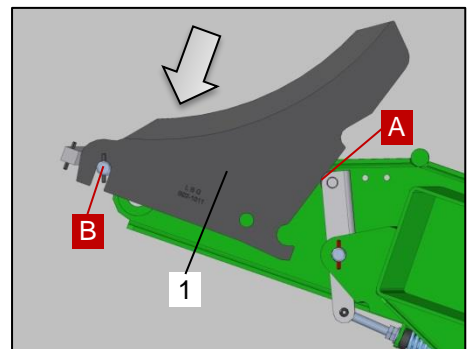

Image 122: Fitting knives



NOTE

When fitting the knives, check whether they fully rest on the shaft at point A. If necessary, remove any load residues from the shaft and the knife and refit the knife.

9.6.5 Sharpening knives

	NOTE
	<p>Always ensure that the knives are in a good, sharpened condition. This will allow trouble-free working without undue strain on the material. This reduces conveyor wear and increases the service life.</p>

	CAUTION!
	<p>Danger of cuts on sharp knives when touching the blades. Danger of flung particles when sharpening the knives. All persons in the vehicle's operating range must wear the following personal protective equipment:</p> <ul style="list-style-type: none"> - Wear eye protection! - Wear hand protection!

	NOTE
	<p>To sharpen the knives, use a grinding machine or an angle grinder with flapped disc.</p> <p> Observe also the notes and instructions in the operating instructions for the grinder.</p>

Remove the knives from the vehicle before grinding. Do this as follows:

- Remove load residues from the rear area of the cutting unit. Pay special attention to the spaces between the springs.
- Fully disengage the cutting unit using the control system on the vehicle.
- Take out the knives.
- Sharpen the knives only on their smooth side. Economical grinding of the knives without heating (tarnishing) extends the knives' service life.
- Refit the knives.
- Engage the cutting unit from the control system on the vehicle.



Observe also the notes and instructions in the operating instructions, chapter "Care and maintenance", section "Cutting unit" / "Removing and fitting knives".



Image 123: Sharpening knives



For detailed information about the vehicle elements mentioned in this section, their functions and associated handling, and instructions and notes for safe operation of the vehicle, see chapters "Functions and settings" and "Operation".

9.6.6 Adjusting the cutting unit

	NOTE
	The cutting unit is optimally set on delivery.

To achieve an ideal crop cut, the distance of the knives (Image 124 / pos. 1) from the rotor drum (Image 124 / pos. 2) must be optimally set. The knives (Image 124 / pos. 1) must not touch the rotor drum (Image 124 / pos. 2).

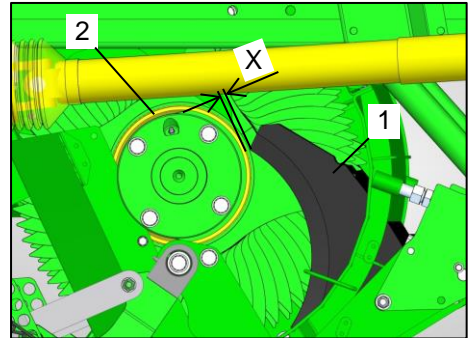

Image 124: Knife setting

Distance X between knife (Image 124 / pos. 1) and rotor drum (Image 124 / pos. 2):	2 - 5 mm
--	----------

The distance must be the same on both sides. If the measured distance does not correspond to the above value, the cutting unit must be adjusted.



Observe also the notes and instructions in the following section “Setting the distance” in these operating instructions.

9.6.6.1 Checking the distance

Do this as follows:

- Fully engage the cutting unit using the control system on the vehicle.
- Enter the cargo space.
- Remove the cover at the rear of the conveying channel.
- On the left side in the conveying channel, measure the distance between knife (image 1 / pos. 1) and rotor drum (Image 125 / pos. 2).
- On the right side in the conveying channel, measure the distance between knife (Image 125 / pos. 1) and rotor drum (Image 125 / pos. 2).

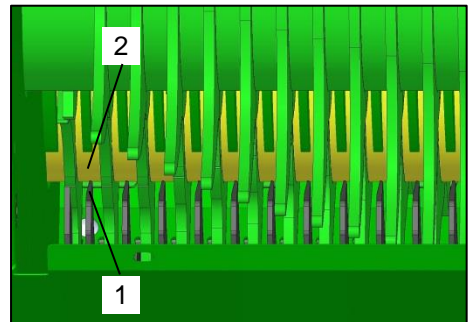





Image 125: Checking the distance

	<p>Correct setting:</p> <p>When the following conditions are fulfilled, the cutting unit is correctly set:</p> <ul style="list-style-type: none"> - The measured values correspond to the ideal distance on both sides - The measured values are the same on both sides.
	<p>Incorrect setting:</p> <p>If one or all of the following points apply, the cutting unit is not correctly set.</p> <ul style="list-style-type: none"> - The measured values do not correspond to the ideal distance on both sides. - The measured values are not identical on both sides.

	NOTE
	<p>If the cutting unit is not set correctly, set and adjust it.</p> <p> Observe the notes and instructions in the following section “Setting the distance” in these operating instructions.</p>



For detailed information about the vehicle elements mentioned in this section, their functions and associated handling, and instructions and notes for safe operation of the vehicle, see chapters “Functions and settings” and “Operation”.

9.6.6.2 Setting the distance

Proceed as follows if the cutting unit (Image 126 / pos. 1) is to be adjusted:

- Using the terminal or the control system on the vehicle, fully disengage the cutting unit (Image 126 / pos. 1).
- Release the locknut (Image 126 / pos. 2) on the side to be set of cutting unit (Image 126 / pos. 1).
- For the adjustment turn the screw (Image 126 / pos. 3) in or out.
- Using the terminal or the control system on the vehicle, fully disengage the cutting unit (Image 126 / pos. 1).
- Use the control system on the vehicle to fully retract the cutting unit (Image 126 / pos. 1).
- Check the setting by checking the distance between the knife and rotor drum.
- Repeat the previous action steps if the distance has not been correctly set. Perform the following action steps once the distance has been optimally set.
- Retighten the locknuts (Image 126 / pos. 2).

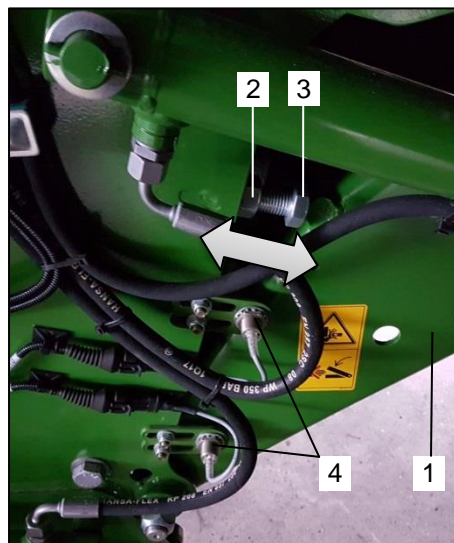



Image 126: Setting the distance



For detailed information about the vehicle elements mentioned in this section, their functions and associated handling, and instructions and notes for safe operation of the vehicle, see chapters “Functions and settings” and “Operation”.

	NOTE
	<p>The cutting unit (Image 126 / pos. 1) is equipped with sensors (Image 126 / pos. 4). If the distance is set, an adjustment of the cutting unit sensors (Image 126 / pos. 4) has to take place subsequently.</p> <p> Observe the notes and instructions in the operating instructions, chapter “Functions and settings”, section “Electrical system”.</p>

9.7 Chassis

9.7.1 Suspension

Even minor damage of the spring surfaces leads to permanent breakage. To ensure a long service life of the springs, observe the following:

- Cover spring material when performing welding work
 - Never work on the springs with sharp objects, hammers, etc.
 - When performing arc welding work, do not connect the negative lead to the spring.
 - Immediately replace any damaged components.
-

9.7.2 Tyres and wheels

Fit only tyres and rims approved by us. Repair work on tyres and wheels must be performed only by qualified personnel with appropriate tools. When working on the tyres, make sure that the vehicle is safely parked and secured against rolling (wheel chocks). Jack the vehicle only at the specified points.

When tyres are defective, the vehicle must be raised to change the wheels only when it is empty. Before jacking up the vehicle, secure it with the parking brake and wheel chocks. When changing a tyre, lift the vehicle by placing a jack under the axle with the tyre to be changed and raise the vehicle so the tyre can be changed.

The tyres should be checked regularly for abnormal folds and other deformations. Remove any foreign objects on or in the tyres immediately, since these will work their way into and damage the tyres. Immediately repair any cuts.

9.7.2.1 Wheel nuts and wheel bolts



Attention!

Retighten wheel nuts:

- ⇒ after 50 km of driving
- ⇒ after further 150 km of driving
- ⇒ after further 400km of driving.

- Within the first operating week the wheel nuts have to be checked on firm fit each day.
- For further operating the wheel nuts have to be checked weekly.



After commissioning of a new vehicle and after a tyre change, retighten the wheel nuts after driving 50 km. After that, the wheel nuts must be retightened after 150 km of driving and again after 400 km of driving.

In the first week of vehicle use, check the wheel nuts for tightness every day. During further operation, check the wheel nuts for tightness once a week.

- Use only original wheel fixing elements.
- Replace any damaged, stiff or rusted wheel nuts and bolts.
- Oil the thread only lightly.
- Tighten wheel nuts crosswise with a torque spanner according to the torque table below.

Maximum tightening torques for wheel nuts

Thread	A/F width	Number of bolts per hub	Max. tightening torque	
			Black	Galvanized
	mm	pce.	Nm	Nm
M 18 x 1.5	24	6	290 Nm (275 – 305 Nm)	320 Nm (300 – 340 Nm)
M 20 x 1.5	27	8	380 Nm (360 – 400 Nm)	420 Nm (400 – 440 Nm)
M 22 x 1.5	32	10	510 Nm (485 – 535 Nm)	560 Nm (535 – 585 Nm)
M 22 x 2	32	10	460 Nm (435 – 485 Nm)	505 Nm (480 – 530 Nm)

Table: Maximum tightening torques for wheel nuts

9.7.2.2 Tyre pressure

Check the tyre pressure at least every two weeks with cold tyres. Caps must be fitted to the valves.

Ø	Designation	Load index	Width	Height	40 km/h		max. km/h			Data from
					Payload	Tyre pressure	Use	Payload	Tyre pressure	
			mm	mm	kg	bar	km/h	kg /	bar	
22.5"	620/40 R 22.5	148D	610	1,085	4,280	3.2	65	3,150	3.2	Vredestein
22.5"	710/35 R 22.5	157D	712	1,069	5,620	4.0	65	4,125	4.0	Nokian

When driving on slopes and difficult terrain, the air pressure must be increased by 25%. The maximum permissible tyre pressure may not be exceeded. When pumping up the tyres and when tyre pressure is too high there is a risk of bursting.

At speeds above 40 km/h, the air pressure in the tyres must be adjusted as specified by the tyre manufacturer

9.7.3 Axles (General)

Never overload axles!

- Do not overload the vehicle by exceeding its legally specified gross weight.
- Do not exceed the maximum speed.
- Avoid one-sided overloading caused through incorrect loading or driving, for example, on curbs.
- Do not fit wheels that are not approved.
- To maintain operational safety, regularly check the setting of the wheel brakes. For details, see the [\[Air brake\]](#).
- All maintenance and repair work on the axles and brake system must be carried out only by specialist garages or authorized specialists.
- When working on the axles, make sure that the vehicle is safely parked and secured against rolling (using wheel chocks).

9.7.3.1 Maintenance

- For maintenance intervals, see the general maintenance schedule (chapter “Care and maintenance”, section “Maintenance schedule”).
- Lubricate as specified in the lubrication schedule. (see chapter “Care and maintenance”, section “Lubrication”)



Axle and brake maintenance must be performed only by authorized workshops.

9.7.3.2 Setting wheel hub bearing play

Check the wheel hub bearing play as follows:

- Lift the axle until the tyres are free.
- Release the brake.
- Check the bearing play.

If play is found in the bearings, do the following:

- Remove the hub cap.
- Remove the cotter pin from the axle nut.
- Tighten the axle nut while rotating the wheel clockwise until the rotation of the wheel hub is slightly braked.
- Turn the axle nut back to the next available cotter pin hole. Turn axle nut back to the next available hole.
- Fit a new cotter pin.
- Fill some grease into the hub cap and mount it on the wheel hub.
- Check wheel for bearing play and free rotation.



Axle and brake maintenance must be performed only by authorized workshops.

9.7.3.3 Changing the wheel hub bearing grease

- Jack up the vehicle safely and release the brakes. Remove the wheels and hub caps.
- Remove the cotter pin and unscrew the axle nut.
- Pull the wheel hub with brake drum and taper roller bearing off the axle with a suitable puller.
- Mark wheel hubs and bearing cages to avoid accidental swapping during reassembly.
- Clean the brakes and check for wear, breakage and function, and replace any worn parts. The inside of the brakes must be free of lubricants and dirt.
- Clean wheel hub thoroughly inside and out. Remove old grease completely. Clean bearings and seals thoroughly (diesel oil) and check whether the parts are still usable.
- Before installing the bearing, lightly grease the bearing seats and assemble all parts in reverse order. Carefully drive press fit parts into seats with a pipe sockets without jamming.
- Prior to assembly, fill the bearings, the wheel hub space between the bearings and the hub cap with grease. The amount of grease should fill one quarter to one third of the free space in the assembled hub.
- Mount the axle nut, and make the required adjustments to the bearing (do not forget the new cotter pin) and to the brake.
- Finally, carry out a function test and a test drive, and correct any discrepancies found.



Axle and brake maintenance must be performed only by authorized workshops.

9.7.4 Follow-up steering axles

The follow-up steering axle minimizes the impact on the ground and growth when driving over it. When the axle is released, the wheels of the follow-up steering axle can adapt when cornering.

Important If the vehicle is equipped with a follow-up steering axle, observe the notes under [[Commissioning and functions - follow-up steering axle](#)].

9.7.4.1 Maintenance

- For maintenance intervals, see the general maintenance schedule (chapter “Care and maintenance”, section “Maintenance schedule”).
- Lubricate as specified in the lubrication schedule. (see chapter “Care and maintenance”, section “Lubrication”)



Axle and brake maintenance must be performed only by authorized workshops.

9.8 Scraper floor**DANGER!****Danger of drawing in or catching of the whole body on driven tools.**

These dangers can cause severe and potentially fatal injuries.

- Never step onto the cargo space when the drive is switched on and the engine is running.
- Always switch off all drives, stop the engine and remove the ignition key before working in the cargo space.
- Before performing any work on the vehicle, secure the tractor and the vehicle against unintentional rolling and starting!
- Keep people out of the tractor and vehicle danger areas and away from moving vehicle parts!



Observe the notes and instructions in the operating instructions, chapter "Commissioning", section "Securing the vehicle against unintentional rolling and starting".

**WARNING!****Danger of crushing, shearing, drawing in and catching for people in the danger area of the running scraper floor, in particular at the reversing points!**

- Instruct people to leave the danger area of the vehicle before starting up the scraper floor and maintain a sufficient safety distance from the running scraper floor.
- Always keep the scraper floor chains tensioned.



Observe the notes and instructions in the operating instructions, chapter "Functions and settings", section "Scraper floor" / "Tensioning systems".

9.8.1 Scraper floor chains



NOTE

Regularly check

- the tension of the scraper floor chains and retension them if necessary.
- the screw connections of the scraper floor bars and retighten them if necessary.



The maintenance intervals are given in the operating instructions, chapter “Care and maintenance”, section “Maintenance schedule”.

9.8.1.1 Retensioning scraper floor chains

Setting instructions

Adjust the chains such that they sag slightly. If chain sag is too great, the chain can skip during reversing. If the chains are too tight, they wear much faster.

Procedure

Do this as follows:

- Release the locknuts (Image 127 / pos. 1).
- The tension of the scraper floor chain can be adjusted with the screws (Image 127 / pos. 2). When doing so, observe the setting instructions.

Releasing screws:	Reduces tension
-------------------	-----------------

Tightening screws:	Increases tension
--------------------	-------------------

- Firmly tighten the locknuts (Image 127 / pos. 1) again.

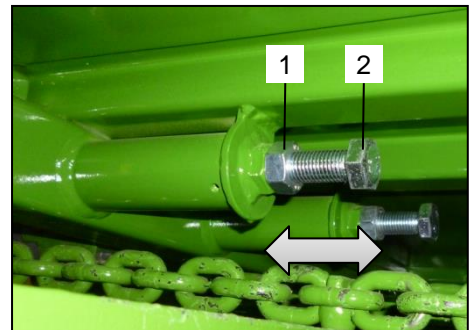

Image 127: Tensioning system

9.8.1.2 Shortening scraper floor chains

When the scraper floor chain return rollers have reached the end of their tensioning range, remove once 2 links from each chain. Do this as follows:

- Release the locknuts (Image 127 / pos. 1).
- Release the screws (Image 127 / pos. 2) until the sprockets can be pushed to the back up to the stop.
- Open the connecting links of the scraper floor chains.
- Shorten the scraper floor chains by 2 links. You must do this on all chains, so that they have the same length after shortening.
- Close the connecting links of the scraper floor chains.
- Tension the scraper floor chains, observing the setting instructions.
- Firmly tighten the locknuts (Image 127 / pos. 1).

9.8.1.3 Shortening scraper floor chains with different strand lengths

Should the scraper floor chains have become elongated at different rates, contact BERGMANN customer service to obtain information about shortening chains.

Customer service line

Jörg Kammacher	 +49 (0)4444 - 2008-15
	 +49 (0)4444 - 2008-43
	 -
Hauptstraße 64-66 49424 Goldenstedt	 kundendienst@l-bergmann.de
	 www.Bergmann-Goldenstedt.de

9.9 Cross conveyor belt

9.9.1 Cleaning the cross conveyor belt



CAUTION!

Danger of flung load residues and dirt particles when cleaning the cross conveyor belt with compressed air.

All persons in the vehicle's operating range must wear the following personal protective equipment:

- Wear eye protection!
- Wear hand protection!



NOTE

Clean the cross conveyor belt with compressed air every day. Do not use pointed or sharp objects when removing load residues from the transport belt.

A cross conveyor belt which is not properly cleaned results in impurities of the load and an increased wear of components.

Clean the cross conveyor belt as follows:

- Pull the cross conveyor belt under the vehicle frame all the way out to the stop.
- Clean the cross conveyor belt with compressed air.
- Remove the load residues from the cross conveyor belt.
- Remove the residues from the guide rails of the cross conveyor belt under the vehicle frame.
- Bear in mind in particular the spaces and openings.

Cleaning of the drive drum and the deflection drum has to be performed when the transport belt is adjusted and retensioned for maintenance reasons. Do this as follows:

- Pull the cross conveyor belt under the vehicle frame all the way out to the stop.
- Loosen the transport belt.
- Remove the residues from the drive drum and from the deflection drum.
- Adjust and tension the transport belt.



Observe the notes and instructions in the operating instructions, chapter "Care and maintenance", section "Cross conveyor belt" / "Adjusting and tensioning the cross conveyor belt"!

9.9.2 Adjusting and tensioning the cross conveyor belt



WARNING!

Risk of injury through movements of tractor and vehicle or of vehicle parts!

- Before performing any work on the vehicle, secure the tractor and the vehicle against unintentional rolling and starting!
- Keep people out of the tractor and vehicle danger areas and away from moving vehicle parts!



Observe the notes and instructions in the operating instructions, chapter "Commissioning", section "Securing the vehicle against unintentional rolling and starting".



NOTE

The transport belt has to be adjusted and tensioned if the following occurs:

- The drive drum slips through.
- Drive drum and deflection drum are not in parallel to each other.
- The transport belt does not run in parallel to the frame of the cross conveyor belt.

The transport belt can be adjusted at the frame of the cross conveyor belt (Image 128 / pos. 1), at the drive drum (Image 128 / pos. 2), at the bearing point opposite the motor and at the deflection drum (Image 128 / pos. 3) at both bearing points.

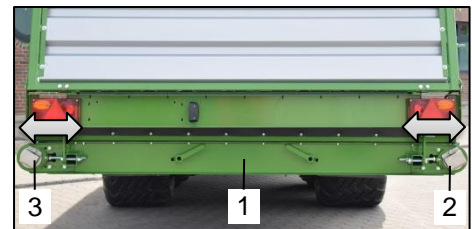

Image 128: Drive drum and deflection drum

Proceed as follows to adjust and tension the cross conveyor belt:

- Remove the mounting screws (Image 129 / pos. 3) of the drum guides at the cross conveyor belt (Image 129 / pos. 1).
- Release the locknuts (Image 129 / pos. 5) for the tensioning screws (Image 129 / pos. 6).
- Release the tensioning screws (Image 129 / pos. 6) until the transport belt is slack.
- Remove the residues from the drive drum (Image 128 / pos. 2) and from the deflection drum (Image 128 / pos. 3).
- Unscrew the tensioning screws (Image 129 / pos. 6) evenly until the belt does not sag anymore.

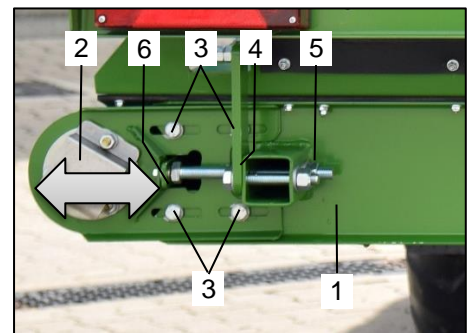

Image 129: Adjusting and tensioning the cross conveyor belt



NOTE

Ensure when adjusting and tensioning:

- That the drive drum and the deflection drum run in parallel.
- That the transport belt runs parallel to the frame of the cross conveyor belt.

If the points mentioned above are not observed, this results in a premature failure of the cross conveyor belt.

- If the previously mentioned points are fulfilled, screw out the tensioning screws evenly for max. 15 mm until the transport belt is correctly tensioned.
- Then retighten the locknuts (Image 129 / pos. 5) and the mounting screws (Image 129 / pos. 3) of the drum guides.

**NOTE**

If the transport belt is too tight, the belt will be overstretched. This results in premature failure of the cross conveyor belt.

Check the settings:

**WARNING!****Danger of drawing in or catching of the whole body on driven tools.**

This can cause severe and potentially fatal injuries.

A test run has to be performed when checking the correct setting of the cross conveyor belt.

- Keep people out of the tractor and machine danger areas and away from moving vehicle parts!
- Do not make any settings while the vehicle is running.

Perform a test run after adjusting and tensioning the cross conveyor belt. Do this as follows:

- Switch on the cross conveyor belt and ensure that the transport belt is running properly taking into account the points mentioned above.
- If this is not the case, repeat the steps for adjusting and tensioning the cross conveyor belt.



Also observe the notes and instructions in the operating instructions, chapter "Functions and settings", section "Cross conveyor belt" / "Starting and stopping the cross conveyor belt".

9.9.3 Setting the cross conveyor belt angle

To check the correct cross conveyor belt angle, the cross conveyor belt must be in the working position.



Observe the notes and instructions in the operating instructions, chapter “Functions and settings”, section “Cross conveyor belt” / “Cross conveyor belt positions”.

Checking the setting:

When the cross conveyor belt (Image 130 / pos. 1) is set correctly, it has to run parallel to the vehicle frame (Image 130 / pos. 2). Proceed as follows to check the setting:

- Fasten a straight rail below the frame rail (Image 130 / pos. 2) of the vehicle. The rail must protrude completely past the cross conveyor belt (Image 130 / pos. 1).
- Measure the distance “X” between the frame rail (Image 130 / pos. 2) and the cross conveyor belt (Image 130 / pos. 1) at the front and rear of the cross conveyor belt.
- Perform the previous steps again on the other vehicle side.
- When the setting is correct, all measured distances must have the same value. If this is not the case, setting has to be carried out.

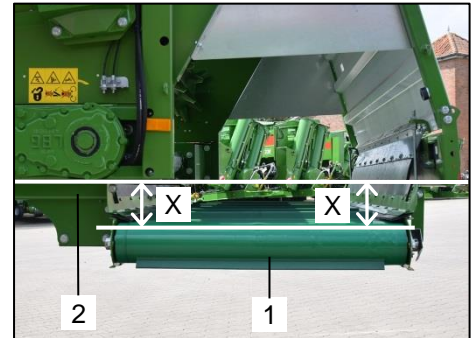

Image 130: Checking the angle

Performing the setting:

If this is not the case, the cross conveyor belt angle has to be set. Do this as follows:

- Release the mounting screws (Image 131 / pos. 2) on both vehicle sides of the cross conveyor belt (Image 131 / pos. 1).
- Lift the cross conveyor belt on the rear:
 - Release the locknut (Image 131 / pos. 8) below the bracket (Image 131 / pos. 5). Also release the adjusting nut (Image 131 / pos. 7) under the bracket until the distance “X” at the front and rear of the cross conveyor belt (Image 131 / pos. 1) has the same value.
 - Firmly retighten the adjusting nut (Image 131 / pos. 6) above the bracket (Image 131 / pos. 5).
 - Firmly retighten the locknut (Image 131 / pos. 8) under the bracket (Image 131 / pos. 5).
- Lower the cross conveyor belt on the rear:
 - Release the adjusting nut (Image 131 / pos. 6) above the bracket (Image 131 / pos. 5) until the distance “X” at the front and rear of the conveyor belt (Image 131 / pos. 1) has the same value.
 - Firmly retighten the adjusting nut (Image 131 / pos. 7) under the bracket (Image 131 / pos. 5).
 - Firmly retighten the locknut (Image 131 / pos. 8) under the bracket (Image 131 / pos. 5).
- Retighten the two mounting screws (Image 131 / pos. 2) on both vehicle sides of the cross conveyor belt (Image 131 / pos. 1) again after the setting.

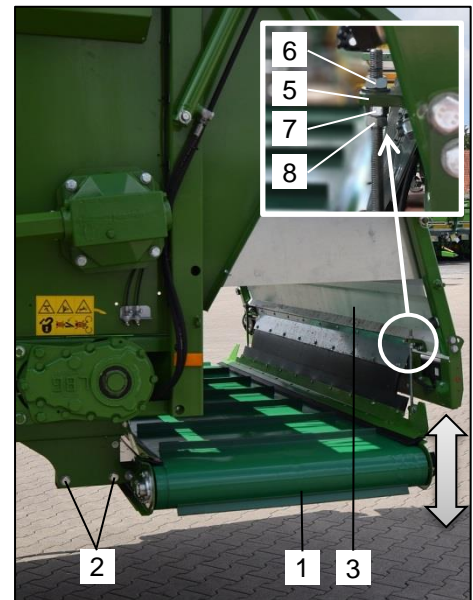

Image 131: Setting the angle

9.10 Lubrication



WARNING!

Risk of injury through movements of tractor and vehicle or of vehicle parts!

- Before performing any work on the vehicle, secure the tractor and the vehicle against unintentional rolling and starting!
- Keep people out of the tractor and vehicle danger areas and away from moving vehicle parts!



Observe the notes and instructions in the operating instructions, chapter "Commissioning", section "Securing the vehicle against unintentional rolling and starting".



WARNING!

Risk of injury through unintentional movement of components!

If raised components are not secured, they can move inadvertently. This can cause serious injuries.

- Always secure raised components against unintentional lowering or operating before working on or under them.
- Keep people out of the vehicle's danger area and away from moving vehicle parts!



CAUTION!

Danger through escaping lubricants.

There is a risk of slipping and injury.

- During installation, operation, maintenance and repairs, watch out for escaping lubricant.
- Immediately seal any leaks.
- Avoid skin contact with oils, grease, cleaning agents and solvents.
- On injuries or burns through oils, cleaning agents or solvents immediately call a doctor.



CAUTION!

Lubricants can pollute waterways and the ground.

- Use and dispose of lubricants properly.
- Observe the regional laws and regulations on disposal.

Lubricant

To ensure trouble-free operation of the vehicle over a long time, a high-quality long-life grease must be used. This grease has the following properties:

- Unusually high adhesion
- Resistance against water
- High pressure-absorption capacity
- High resistance to ageing
- High work resistance

Initial greasing of the vehicle has been performed with this grease. This grease is commercially available.

Where lubricants can enter fodder or the ground, use environment-friendly biodegradable oils and greases.

	<p>NOTE</p>
	<p>Biodegradable oils are NOT authorized for use in lubrication systems for roller chains and must NOT be used.</p> <p>Grease with solids, such as graphite, are NOT approved for central lubrication systems and must NOT be used.</p> <p> Observe also the notes and instructions in the operating instructions, chapter “Care and maintenance”, section “Lubrication” / “Lubrication system”. </p> <ul style="list-style-type: none"> • Use only oils and greases approved by the manufacturer. • Ensure correct disposal of lubricants.

Lubrication points



Observe also the notes and instructions in the operating instructions, chapter “Care and maintenance”, section “Lubrication” or the lubrication schedule.

	<p>B06-0084</p>
	<p>Lubrication points</p> <p>This identification sticker marks lubrication points on the vehicle.</p> <ul style="list-style-type: none"> • The lubrication points must be lubricated according to the lubrication schedule (see “Maintenance & Care” section).

When lubricating the drive components, such as



- drive shafts,
- gearboxes,
- drive chains / roller chains,
- etc.,

observe also the notes and instructions in the operating instructions, chapter “Maintenance and care”, section “Drive”.













	<p>NOTE</p>
	<p>Before lubricating, remove any dirt from the lubrication points.</p>



9.10.1 Lubrication schedule

The lubrication schedules list the lubrication points with their respective lubrication intervals. The given intervals assume an average utilization of the vehicle. In case of a higher utilization and extreme operating conditions, reduce the intervals.

Legend

In the lubrication schedule, the lubrication points and intervals are indicated with symbols. The symbols have the following meanings:

Symbol	Lubrication points	Action	Interval	Remark
	Lubrication point	Apply grease	Every 25 trips	<ul style="list-style-type: none"> - Approx. two strokes from the grease gun - Remove any excess grease on the lubrication point.
	Lubrication point	Apply grease	Every 50 trips	
	Lubrication point	Apply grease	Every 100 trips	
	Lubrication point	Apply grease	Every 250 trips	
	Lubrication point	Apply grease	Every 500 trips	
	Lubrication point	Apply grease	Every 1000 trips	
4 	4 lubrication points	Apply grease	Depending on symbol	
	Roller chain	Lubricate / oil with plant-based oil	Every 50 trips	<ul style="list-style-type: none"> - Apply a thin, even layer with a brush or spray can. - Remove any old and excess oil.
	Roller chain	Lubricate / oil with plant-based oil	Every 100 trips	
4 	4 roller chains	Lubricate / oil with plant-based oil	Depending on symbol	
	Sliding surfaces	Lubricate / oil with plant-based oil	Every 25 trips	
	Gearbox oil	Replace	Annually	Observe the notes and instructions in the operating instructions, chapter "Care and maintenance", section "Drive" / "Gearbox".

Symbol	Description
	Cross-reference to subsequent pages
	Cross-reference to another section in chapter "Care and maintenance", e.g. <ul style="list-style-type: none"> - subsection "Drive shafts" in section "Drive", - subsection "Axles" in section "Chassis", - etc.
	Direction of travel

9.10.1.2 Lubrication schedule ROYAL - Model "S"

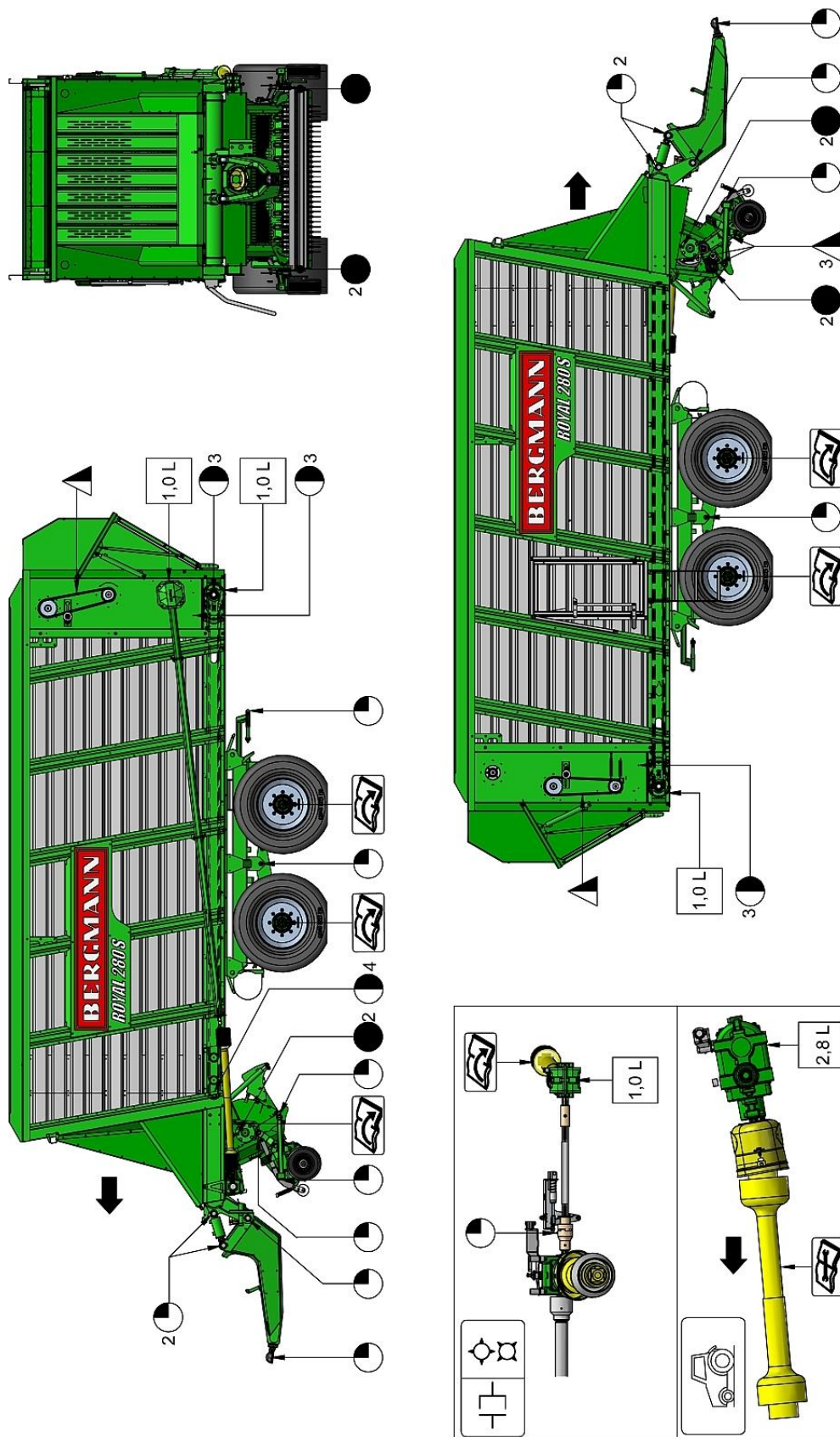
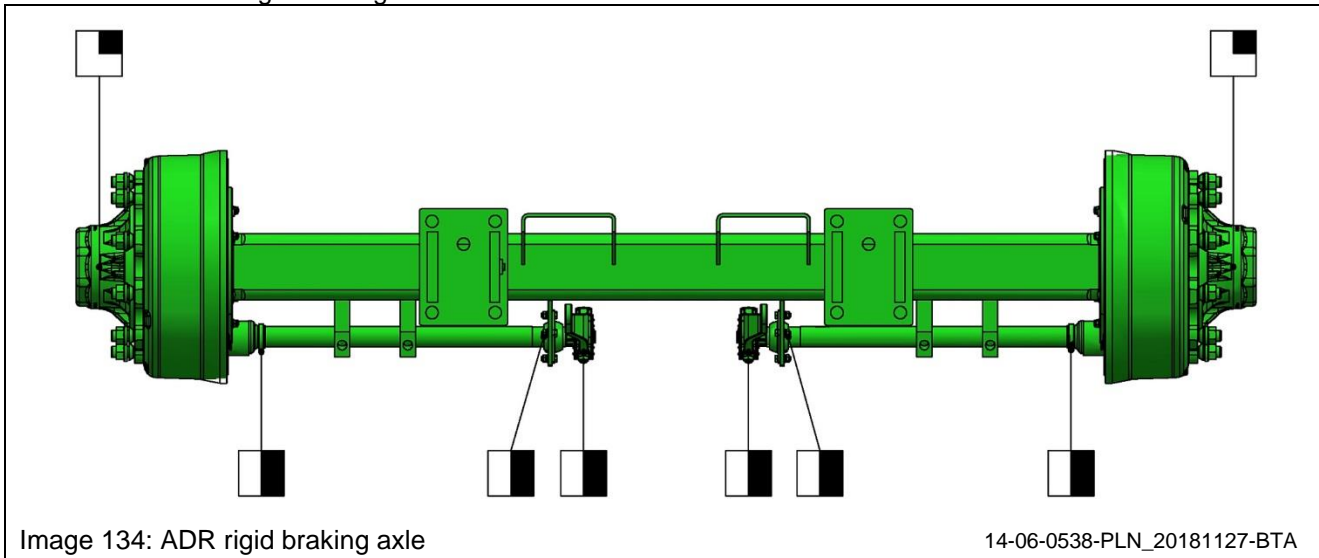

Image 133: Lubrication schedule ROYAL - Model "S"

27-00-0101-PLN_20180502-BTA

9.10.1.3 Lubrication schedule, axle

Version: ADR rigid braking axle



9.10.1.4 Lubrication schedule, axle

Version: ADR steering axle

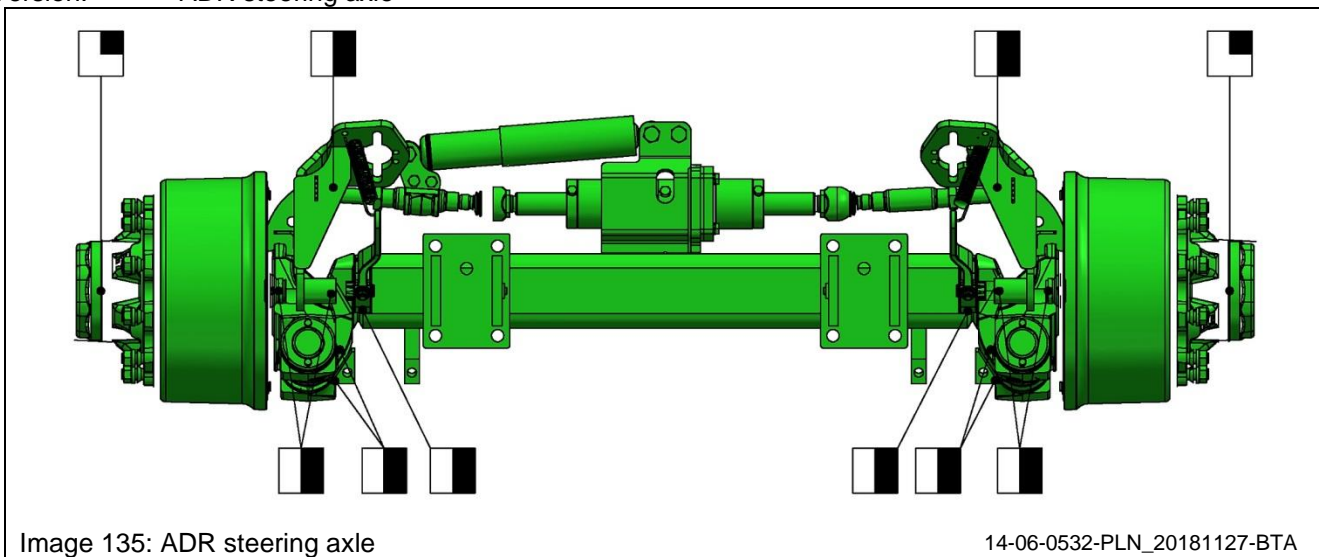

9.10.1.5 Lubrication schedule cross conveyor belt

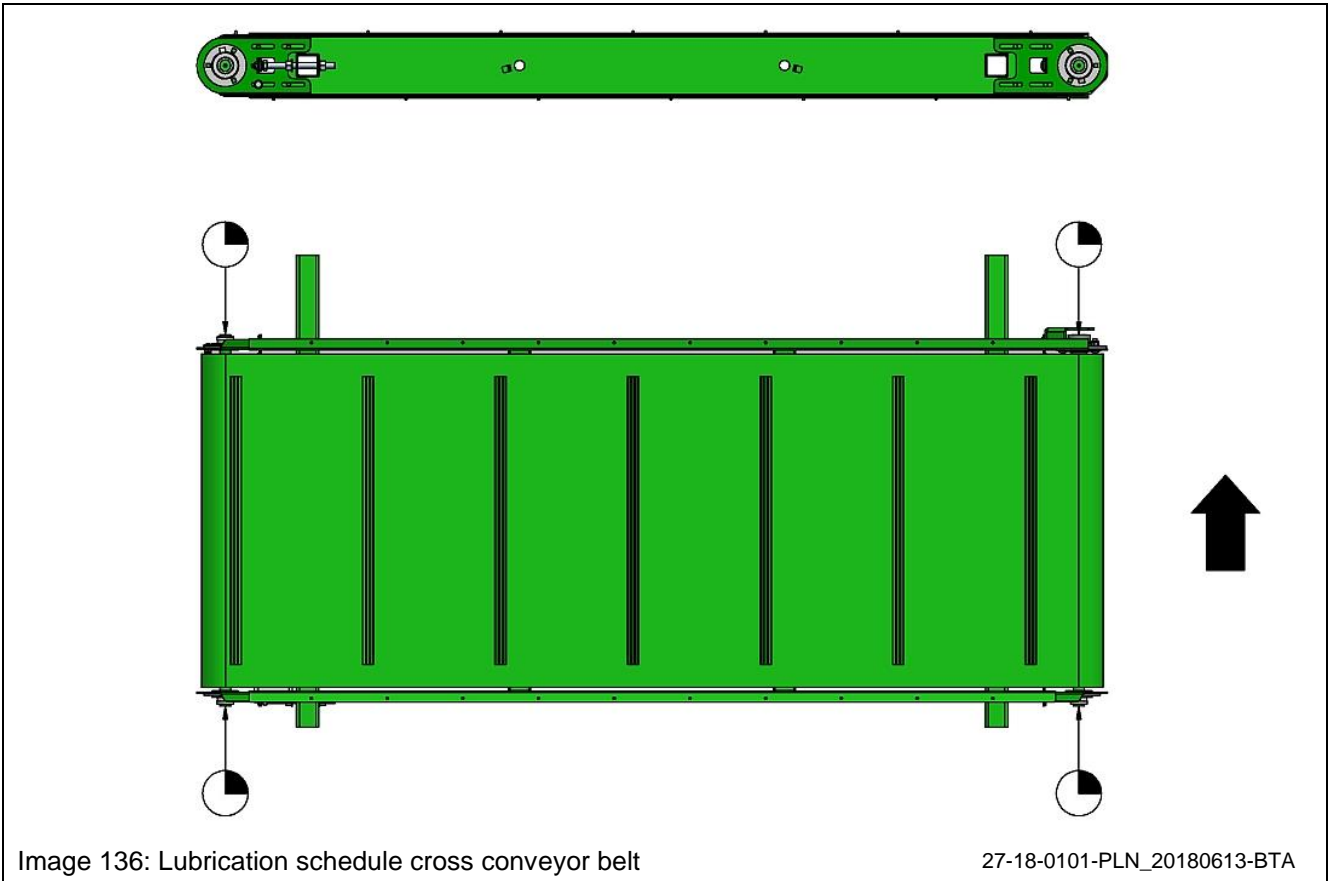

9.10.2 Lubrication system



WARNING!

Danger through system pressure / hydraulic pressure.

Lubrication systems are under high pressure during operation.

- Before starting installation, maintenance or repair work and before making modifications or repairs on the vehicle, lubrication systems must be depressurized.



NOTE

The lubrication system works automatically. A visual check of the lubricant flow in the lubrication lines should nevertheless be performed regularly.

- Check all lubrication points for sufficient grease supply every day!
- Top up grease at the lubricating nipples of the drive shafts and other lubrication points on rotating components according to the lubrication schedule.



Observe also the notes and instructions in the manufacturer's operating instructions for the supplied lubrication system.

9.10.2.1 Cleaning the lubrication system

If necessary, the lubrication system can be cleaned with mild, compatible (not alkaline, no soap) cleaning agents. For safety, the product should be disconnected from electrical power and the hydraulic and/or compressed air supply. During the cleaning, make sure that no cleaning agent gets inside the product. Internal cleaning of the product is not necessary under normal operation and when using lubricants that are compatible with each other. If wrong or a contaminated lubricant has inadvertently been filled, the product must be cleaned internally. To do this, contact the manufacturer of the lubrication system.

9.10.2.2 Maintenance of the lubrication system

- Check the lubricant reservoir fill level every day. If necessary, top up lubricant.
- To ensure correct function and prevent dangerous situations, regularly check all connections for tightness. Every time after refilling the lubricant reservoir and after long operating pauses, check the system's components (lubricant lines, connections, seals, etc.) for leaks before taking the vehicle into operation again. If you find any leaks, replace the faulty component.
- When refilling the lubricant reservoir, visually check the lubricant at the lubrication points (such as bearings). The probable cause of insufficient lubrication is a fault in the lubrication system or a faulty system configuration.
- After long standstill times, check the electrical cables for damage before taking the vehicle into operation again. Replace any damaged cables.
- Check the electrical connections and contacts for tightness and corrosion twice a year. Tighten any loose contacts. Clean any corroded electrical contacts with a wire brush and, after connecting them, lightly grease them with contact grease.

9.10.2.3 Filling lubricant on roller chain lubrication system

	NOTE
	<p>Always observe the following points:</p> <ul style="list-style-type: none"> • Use only lubricants approved for the product. Unsuitable lubricants can cause product failure and material damage. • Fill only clean lubricant with a suitable device. Contaminated lubricants can cause serious system malfunctions. Fill the lubricant reservoir without bubbles. • Do not mix different lubricants, as this can cause damage and require complicated cleaning of the lubrication system. To avoid inadvertent mixing of lubricants, we recommend applying a label with the used lubricant to the lubricant reservoir.

Lubricant:

Oils in accordance with ISO VG > 25 mm²/s

Use a thin mineral oil, machine oil or an engine or gearbox oil. The viscosity of the lubricating oil should be chosen such that the oil remains mobile under all ambient temperatures. Specifically, that means oils with a viscosity of SAE 20 to SAE 50 or from 50 to 300 ISO VG at 40 °C.

	NOTE
	<p>Biodegradable oils are NOT authorized for use in lubrication systems for roller chains and must NOT be used.</p>

Procedure:

The lubrication pump offers the following possibilities for lubricant filling:

- Via grease nipple (Image 137 / pos. 2) and grease gun,
- Via filling coupling (Image 137 / pos. 3) and filling pump.



Image 137: Lubrication pump

	NOTE
	<p>Do NOT remove the cover to fill the lubricant reservoir, since any warranty claim becomes invalid otherwise.</p>

Fill the reservoir (Image 137 / pos. 1) with lubricant as follows:

Grease nipple (M10x1) and grease gun:

- Remove the cap from the grease nipple (Image 137 / pos. 2).
- With a commercial grease gun, apply the correct lubricant at the grease nipple (Image 137 / pos. 2) and fill the reservoir (Image 137 / pos. 1).
- Then refit the cap to the grease nipple (Image 137 / pos. 2).

Filling coupling and filling pump:

- Screw the filling pump (Image 138 / pos. 1) onto the reservoir (Image 138 / pos. 2).
- Clean the coupling elements at the pressure hose (Image 138 / pos. 3) of the filling pump.
- Remove the cap from the filling coupling at the lubrication pump (Image 137 / pos. 3), connect the pressure hose of the filling pump (Image 138 / pos. 3) and fill the reservoir (Image 137 / pos. 1).
- Then refit the cap to the filling coupling of the lubrication pump (Image 137 / pos. 3).

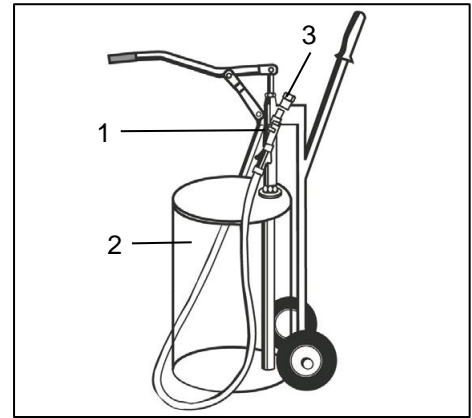



Image 138: Filling pump

9.10.2.4 Filling lubricant on central lubrication systems

	NOTE
	<p>Always observe the following points:</p> <ul style="list-style-type: none"> • Use only lubricants approved for the product. Unsuitable lubricants can cause product failure and material damage. • Fill only clean lubricant with a suitable device. Contaminated lubricants can cause serious system malfunctions. Fill the lubricant reservoir without bubbles. • Do not mix different lubricants, as this can cause damage and require complicated cleaning of the lubrication system. To avoid inadvertent mixing of lubricants, we recommend applying a label with the used lubricant to the lubricant reservoir.

Lubricant:

Grease up to NLGI class 2 DIN 51818 and a flow pressure of max. 700 mbar. Multi-purpose grease with EP additives, compatible with plastics, NBR elastomeric, copper and copper alloys is recommended.

The list of authorized lubricants is being constantly updated and can be found under the following address: <http://www.skf.de> The above specifications are authoritative.

	NOTE
	<p>Grease with solids, such as graphite, are NOT approved for central lubrication systems and must NOT be used.</p>

Procedure:

If the reservoir is drained below the “Min” mark, the entire system must be bled. Do this as follows:

- Disconnect the main line from the lubrication pump. Pump until bubble free lubricant exits the elbow stud coupling. Connect the main line.
- Disconnect the main line from the main distributor. Pump until no more air is in the line. Connect the main line.
- Disconnect the secondary line from the main distributor. Pump until bubble free lubricant exits all main distributor connections. Connect the secondary line.
- Bleed the secondary lines, secondary distributors, lubrication lines and lubrication points and conduct functions checks.

Fill the reservoir (Image 139 / pos. 1) with lubricant as follows:

- Remove the cap from the lubrication point (Image 139 / pos. 2).
- With a commercial grease gun, apply the correct lubricant at the lubrication point (Image 139 / pos. 2) to fill the reservoir (Image 139 / pos. 1).
- Then refit the cap to the lubrication point (Image 139 / pos. 2).

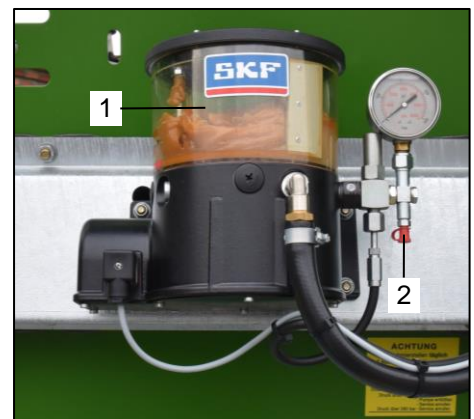

Image 139: Lubrication pump

9.11 Drive

9.11.1 Drive shaft



Observe also the notes and instructions in the drive shaft manufacturer's operating instructions.

9.11.1.1 Maintenance of the Walterscheid drive shaft

Lubrication points and grease quantities

Grease type:	Lithium-saponified
Consistency class:	NL-GI2
Amount of grease:	15g = approx. 5 strokes



The maintenance intervals are given in the following section "Maintenance intervals".

Without wide-angle joint	With wide-angle joint
Image 140: Drive shaft without wide-angle joint	Image 141: Drive shaft with wide-angle joint

Procedure

- 1 Joints
- 2 Guard bearing
- 3 Protective tube

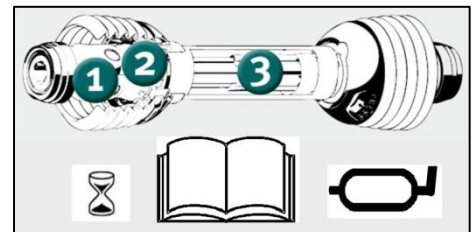

Image 142: Drive shaft design

Joints **1** and guard bearing **2**

- Push back the guard cone (Image 143 / pos. 1).
- Lubricate the universal joint and the guard bearing. Lubricate until grease escapes at the joint seals.
- Return the guard cone back to its normal position (Image 143 / pos. 1).

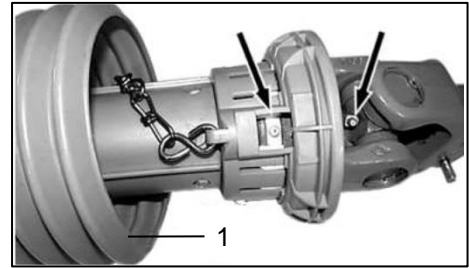

Image 143: Joints and guard bearings

Protective tube **3**

- Push back the cover (Image 144 / pos. 1).
- Pull the drive shaft apart and twist it and the guard until the lubrication point is in the opening (Image 144 / pos. 2).
- Lubricate the protective tubes. On star tubes, lubricate both lubrication points. (offset by 180°)
- After lubrication, close the opening with the cover (Image 144 / pos. 1).

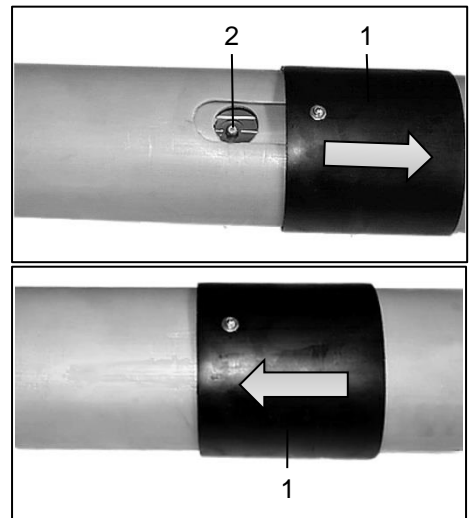

Image 144: Protective tubes

If no cover or lubrication point is available, do the following:

- Pull the drive shaft apart.
- Pull the shaft half with the insert tube out of the guard.
- Lubricate the insert tube.

Maintenance intervals

Application-specific maintenance reduces maintenance costs. It was for this purpose that GKN Walterscheid introduced maintenance classes. The maintenance required for GKN Walterscheid drive shafts is easily seen on

an application-specific maintenance chart. (The new maintenance intervals were confirmed by GKN Walterscheid through an intensive, five-year testing programme.)

	1	2	3	P - Line PWE / PWZ			W - Line WWE / WWZ			ECO - Line E		
				1	2	3	1	2	3	1	2	3
1	Maize, Wheat, Farm	250 h	60 h	100 h	100 h	8 h	60 h	8 h				
	Grass, Hay			250 h**								
2	Tillage, Harvesting	250 h	40 h	50 h	8 h	40 h	8 h					
	Planting, Weeding	100 h*										

Image 145: Maintenance intervals 20180403-123456-BTA

There will be a difference in the maintenance classes depending on the application and design of the drive shaft. Applications are divided into two classes.

- Maintenance class 1 stands for lower-maintenance applications, such as grass or maize harvest.
- Maintenance class 2 includes higher-maintenance work, such as tillage and beat harvesting.

On the second level, the drive shaft design is evaluated. Wide-angle and standard shafts are classified by their technical design. This determines the maintenance intervals for 1 joints, 2 guard bearings and 3 protective tubes

The design and production series can be found on the drive shaft guard label (Image 146).

1 = size

Example: P 400 → Series P

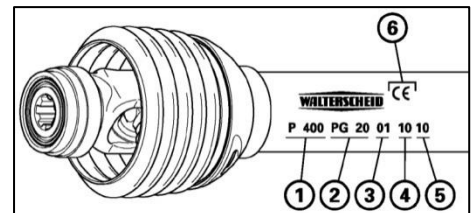

Image 146: Marking

9.11.1.2 Maintenance of Walterscheid overload clutch and overrunning clutch

Lubrication points and grease quantities

Grease type:	Lithium-saponified
Consistency class:	NL-GI2
Amount of grease:	3 g = 1 stroke



The lubricating intervals are given in the following section "Maintenance intervals".

Radial pin clutch

Lubrication interval:	250 h
Amount of grease:	K31/32: 15 g = approx. 5 strokes
	K33/34: 30 g = approx. 10 strokes
	K35/36: 45 g = approx. 15 strokes

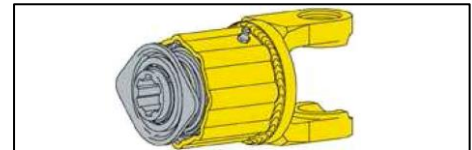

Image 147: Radial pin clutch

Shear bolt coupling

Lubrication interval:	250 h
Amount of grease:	6g = approx. 2 strokes

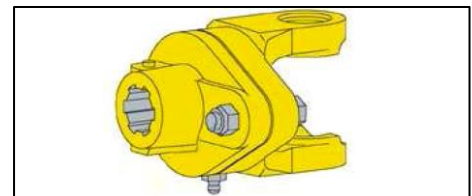

Image 148: Shear bolt coupling

Cam clutch / key type clutch

Lubrication interval:	500 h
Grease type:	Special grease Agraset 116;147

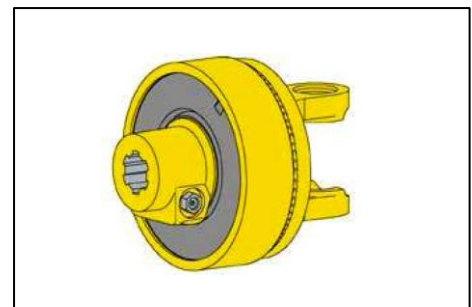

Image 149: Cam clutch / key type clutch

Friction clutch

Series K92, K96, K97	Series K90, K94, K92E
<p>Image 150: Friction clutch K92, K96, K97</p>	<p>Image 151: Friction clutch K90, K94, K92E</p>
<p>Notes on disengaging:</p> <ul style="list-style-type: none"> • Evenly tighten the nuts (Image 150 / pos. 1 or pos. 3); this relieves the friction disks. • Turn the clutch. • Retighten the nuts (Image 150 / pos. 2 or pos. 4) all the way to the end of the thread. 	<p>Notes on disengaging:</p> <ul style="list-style-type: none"> • Measure dimension “L” at the compression spring (Image 151 / pos. 5) or at the adjustment screw (Image 151 / pos. 6). • Release the screws to relieve the friction disks. • Turn the clutch. • Set the screws to dimension “L” again.

Overrunning clutch

Lubrication interval:	250 h
Amount of grease:	15g = approx. 5 strokes

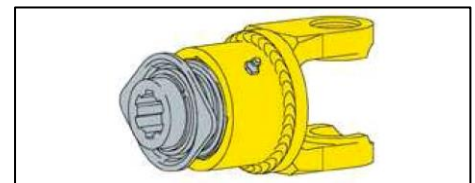



Image 152: Overrunning clutch

9.11.2 Gearbox

	CAUTION!
	<p>Danger through escaping lubricants.</p> <p>There is a risk of slipping and injury.</p> <ul style="list-style-type: none"> • During installation, operation, maintenance and repairs, watch out for escaping lubricant. • Immediately seal any leaks. • Avoid skin contact with oils, grease, cleaning agents and solvents. • On injuries or burns through oils, cleaning agents or solvents immediately call a doctor.

	CAUTION!
	<p>Lubricants can pollute waterways and the ground.</p> <ul style="list-style-type: none"> • Use and dispose of lubricants properly. • Observe the regional laws and regulations on disposal.

	NOTE
	<ul style="list-style-type: none"> • Check the gearboxes regularly for leakage and, if necessary, check the oil level. Top up the gearbox oil if necessary. • Change the oil once a year.

9.11.2.1 Gearbox oil

The following gearbox oils can be used:

- SAE 85W-90 or higher-grade (e.g. ISO VG 320)
- ISO VG320 mineral oil (mobil 600 XP 320 or equivalent)



The following section lists the drives with their assigned gearboxes and the specified gearbox oil with required filling quantities.

9.11.2.2 Gearbox allocation and filling quantities

Main driveCentral gearbox

Version:	Bevel gearbox
Number	B02-0943
Fill level	2,8 litres
Gearbox oil:	ISO VG320 mineral oil (mobil 600 XP 320 or equivalent)

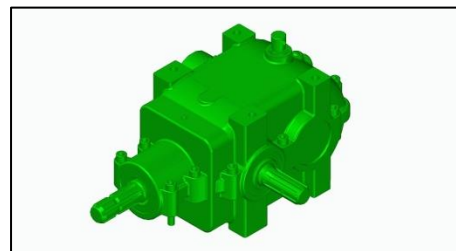

Image 153: B02-0943

Scrapper floorLeft & right drive shaft

Version:	Spur gearbox
Number	B02-0782
Fill level	1.0 litres
Gearbox oil:	ISO VG320 mineral oil (mobil 600 XP 320 or equivalent)

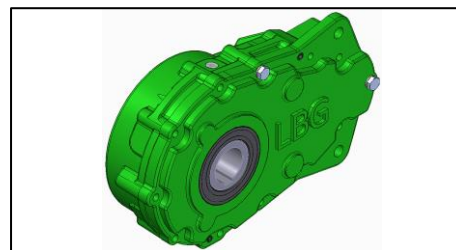

Image 154: B02-0782

Dosing unit (only on vehicle type S)Side transmission

Version:	Bevel gearbox
Number	B02-1037
Fill level	1.1 litres
Gearbox oil:	ISO VG320 mineral oil (mobil 600 XP 320 or equivalent)

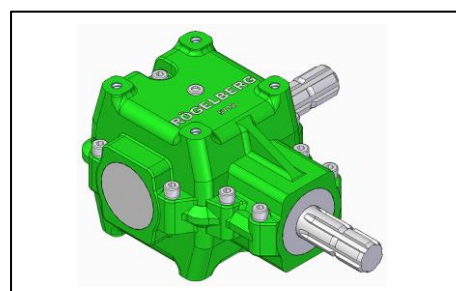

Image 155: B02-1037

Dosing roller bottom / right

Version:	Bevel gearbox
Number	B02-1319
Fill level	1.0 litres
Gearbox oil:	ISO VG320 mineral oil (mobil 600 XP 320 or equivalent)

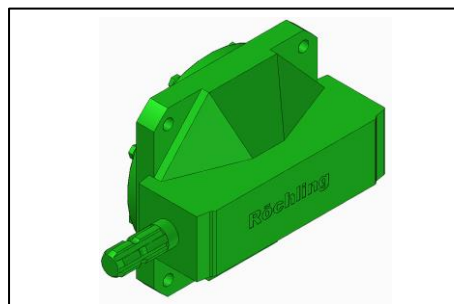

Image 156: B02-1319

9.11.3 Roller chains



NOTE

- Check the chain tension every day.
- If the chain tension is insufficient, retension the chain.
- If the tensioning range has reached its limit, you may have to replace the chains.

9.11.3.1 Conveyor unit drive

A strong roller chain (Image 157 / pos. 1) drives the rotors of the conveyor unit. The chain is tensioned with a spring-loaded chain tensioner (Image 157 / pos. 2).

Retensioning the roller chain

Retension the roller chain (Image 157 / pos. 1) as follows:

- Release the locknut (Image 157 / pos. 3).
- Adjust the nut (Image 157 / pos. 4) until the desired chain tension has been reached.
- Then retighten the locknuts (Image 157 / pos. 3).

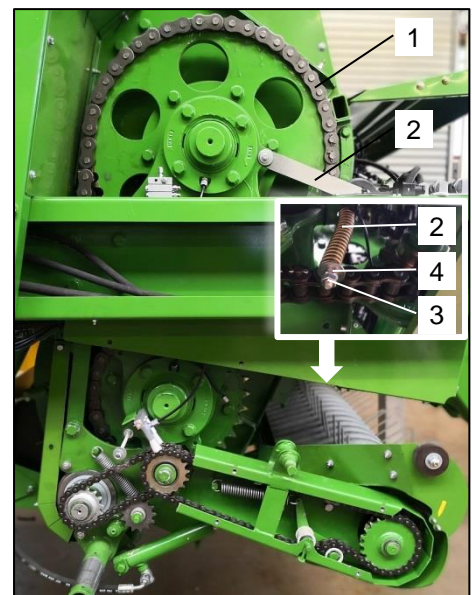

Image 157: Conveyor unit drive

Replacing the roller chain

You must proceed as follows if the roller chain of the conveyor unit has to be replaced:

- Remove the roller chain of the conveyor unit.
- Align the rotors optimally. The procedure for aligning the rotors is described in the following section.
- Align the roller chain optimally. The procedure for aligning the roller chain is described in the following section.
- Lock the roller chain with the chain lock.

Alignment of the rotors

An alignment of the rotors must be carried out when replacing the roller chain (Image 158 / pos. 1) of the conveyor unit. The alignment takes place via the outer transport fins of the rotor on the right-hand side of the vehicle and the holes in the right-side plate. A hole (Image 158 / pos. 2) is provided for the cutting rotor and 3 holes (Image 158 / pos. 3) are available for the press rotor.

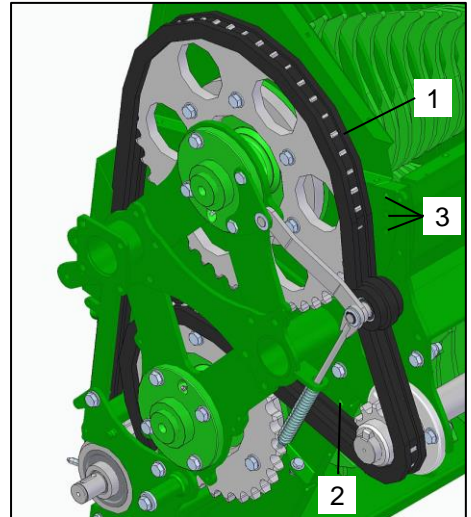

Image 158: Aligning the conveyor unit

Aligning the cutting rotor:	Aligning the press rotor:
<p>Image 159: Aligning the cutting rotor</p> <p>The outer transport fin of the cutting rotor must be visible through the hole (Image 159 / pos. 1) on the right-hand side of the vehicle. If no transport fin is visible, the cutting rotor has to be turned further accordingly.</p>	<p>Image 160: Aligning the press rotor</p> <p>The outer transport fin of the press rotor must be visible through the middle hole (Image 160 / pos. 2) on the right-hand side of the vehicle. If the fin is visible in the upper or lower hole, the alignment is still acceptable. If no transport fin is visible, the press rotor has to be turned further accordingly.</p>

Alignment of the roller chain

After you have carried out the optimum alignment of the rotors, place the roller chain (Image 161 / pos. 1) on and around the sprockets of the conveyor unit drive, as illustrated in Image 161. Note that the chain lock of the roller chain (Image 161 / pos. 2) must be located between the chain drive sprocket (Image 161 / pos. 3) and the tension roller (Image 161 / pos. 4).

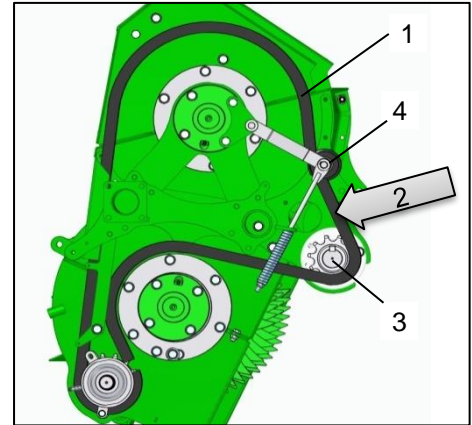

Image 161: Aligning the roller chain

9.11.3.2 Pick-up drive

Two strong roller chains (Image 162 / pos. 1) drive the pick-up. The chain is tensioned with a spring-loaded chain tensioner (Image 162 / pos. 2). The chain length and the position of the pick-up influence the position of the chain tensioner. Sufficient distance to the adjacent components (such as sprocket, cover, etc.) has to be kept.

The chains of the pick-up are tensioned in the raised position. Subsequently the pick-up is lowered to check the remaining spring tension.

The tensioning arm bearing of the chain tensioner (Image 162 / pos. 2) has to be checked for freedom of movement.

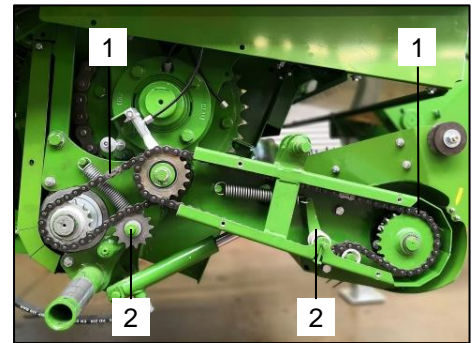

Image 162: Pick-up drive

9.11.3.3 Dosing unit - drive (depending on the vehicle's equipment)

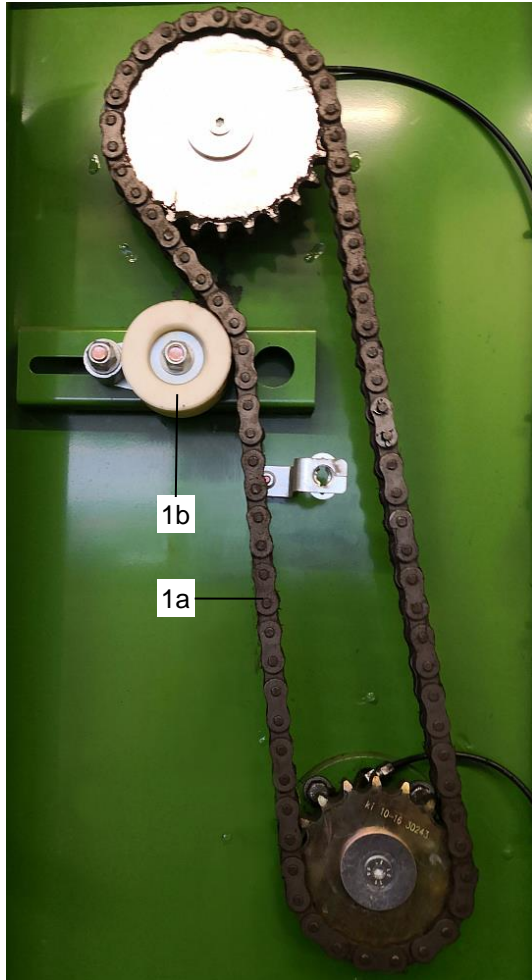

Image 163: Dosing unit – left drive

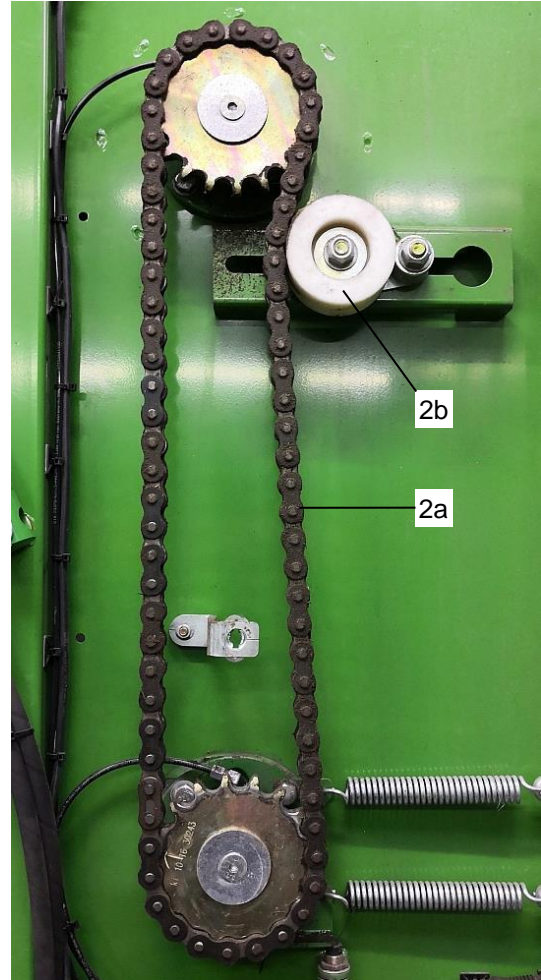

Image 164: Dosing unit – right drive

The metering roller is driven by two robust roller chains (Image 163 / pos. 1a + Image 164 / pos. 2a). The roller chains are tensioned with chain tensioning blocks (Image 163 / pos 1b + Image 164 / pos. 2b).

Retensioning the roller chains

Retension the roller chains (Image 165 / pos. 1) as follows:

- Open the cover.
- Release the two nuts (Image 165 / pos. 3).
- Tension the roller chain (Image 165 / pos. 1) by moving the chain tensioning block (Image 165 / pos. 2).
- After the adjustment, retighten the two nuts (Image 165 / pos. 3).
- Close the cover.



Image 165: Chain tensioning block

9.11.4 Clutches on vehicle type “S”

When opening the tailgate the conveyor unit and the pick-up are switched off and the dosing unit is switched on. When the tailgate is closed again, the clutches switch over again.

9.11.4.1 Conveyor unit coupling

When the tailgate is closed, the hydraulic cylinder of the coupling (Image 166 / pos. 1) is extended, the conveyor unit and the pick-up can be switched on.

The coupling is set optimally in the factory.

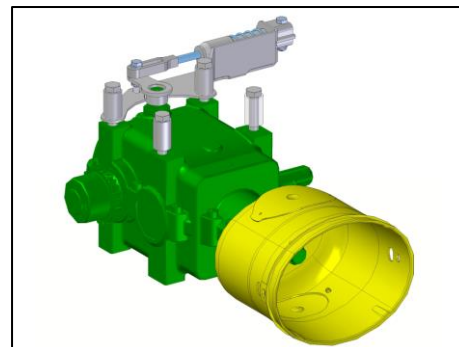

Image 166: Conveyor unit coupling

9.11.4.2 Dosing unit clutch

Clutch disengaged	Clutch engaged
<p>Image 167: Clutch disengaged</p> <p>The clutch (Image 167 / pos. 1) is disengaged</p> <ul style="list-style-type: none"> - when the hydraulic cylinder of the clutch is retracted (Image 167 / pos. 2), - when the tailgate is closed. 	<p>Image 168: Clutch engaged</p> <p>The clutch (Image 168 / pos. 1) is engaged</p> <ul style="list-style-type: none"> - when the hydraulic cylinder of the clutch (Image 168 / pos. 2) is extended, - when the tailgate is open.

Setting the clutch



NOTE

When the clutch is engaged, the ball bearing (Image 169 / pos. 1) must be able to rotate freely.

The clutch is set correctly if the ball bearing (Image 169 / pos. 1) can also turn freely when the clutch is engaged. The hydraulic cylinder (Image 169 / pos. 2) is extended.

To change the setting, do the following:

- Release the mounting screws on the shift console (Image 169 / pos. 3).
- Move the shift console (Image 169 / pos. 3) and clutch element (Image 169 / pos. 4), until the clutch elements (Image 169 / pos. 4 + pos. 5) are fully closed.
- Retighten the mounting screws on the shift console (Image 169 / pos. 3).
- Release one of the nuts (Image 169 / pos. 6) on the tensioning bolt (Image 169 / pos. 7).
- Turn the tensioning bolt (Image 169 / pos. 7) in or out until the ball bearing (Image 169 / pos. 1) can rotate freely.
- Retighten the nuts (Image 169 / pos. 3).

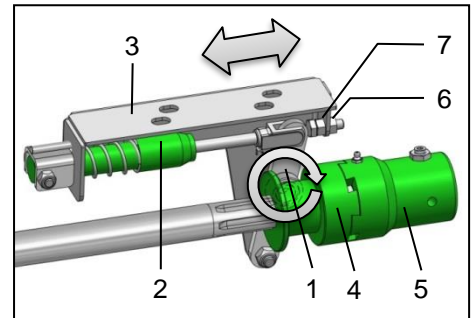

Image 169: Setting the clutch (2)

9.12 Hydraulic system

Important! Ensure maximum cleanness when working on the hydraulic system.

9.12.1 Hydraulic system – circulating hydraulics

9.12.1.1 Hydraulic oil filter

The hydraulic system is equipped with a pressure filter to protect the hydraulic manifold / control block against contamination (Fig.: Hydraulic oil filter pos. 1).

Replace the filter cartridge once a year as follows:

- Depressurize the hydraulic system
- Unscrew the filter bowl
- Remove the soiled cartridge
- Clean the filter bowl
- Oil the seal of the new cartridge and slide it in up to the stop
- Grease the bowl thread
- Screw in the bowl up to the stop (tightening torque 150 Nm).



Image: Hydraulic oil filter

9.13 Brake system

9.13.1 Parking brake

The parking brake must be adjusted when

- 75% of the spindle length is needed to engage the parking brake
- the brake linings have been renewed.

When the parking brake is fully released, the brake cable should sag slightly.



Image: Parking brake

Adjust the parking brake as follows:

- Release the three brake cable clamps on the end of the brake cable.
- Shorten the brake cable as required and retighten the brake cable clamps. (Do not change the assignment of the bracket or the adapter of the cable clamp to the brake cable).
- Check parking brake function.

Check the brake cylinders for damaged boot or bellow every 3 to 4 months. Replace any damaged parts. Check all hinged connections (brake valves, brake cylinder, brake linkage, etc.) for freedom of movement. Lightly oil or grease parts if necessary.

9.13.2 Air brake system

- A thorough brake system inspection is to be conducted on a regular basis.
- Adjustments and repairs to the brake system may only be carried out by a specialist garage or an authorized brake service contractor.
- Ensure that seals are clean and in good condition before coupling the two brake hoses. Replace damaged seals. Ensure no air escapes when coupled.
- Observe assignment of couplings:
 - Coupling head Red → Reserve
 - Coupling head Yellow → Brake line
- Ensure correct positioning of the hoses.
- Diagrams of the compressed air system are contained in the spare parts list.

9.13.2.1 Trailer brake effect regulator (manual adjustment) (if fitted)

When operating the trailer, the brake pressure must be adapted to the trailer load. For this, the trailer brake effect regulator must be adjusted manually.

The regulator can be set to full load, half load, empty or released. The symbols on the valve are explained below.

 = Full load (trailer has rated gross weight)

 = Half load (trailer carries half of its payload)

 = Empty (trailer is unladen)

 = Released (the brakes are released so that the uncoupled trailer can be moved)

Depending on the equipment of the machine, a separate release valve (blue or black head) near the control valve can be used for this purpose.



An incorrect brake pressure setting can cause increased brake and tyre wear. If the brake pressure is set too high this can cause the wheels to block; if the air pressure is set too low, this can reduce the brake effect, resulting in a dangerous driving condition.

9.13.2.2 ALB – automatic load sensing brake effect regulator (if fitted)

The brake pressure automatically adapts to the axle load. The settings must be in accordance with the ALB identification plate and must not be changed.

Check the brake effect regulator adjusting shaft for freedom of movement and the hinge for possible damage every 3-4 months.

9.13.2.3 Draining the air tank

Drain water from the air tank every day before starting a trip. To do this, pull the drain valve pin at the bottom of the air tank to the side until no more water comes out. If the drain valve is dirty, remove it from the depressurized tank and clean it.

The air tank must not be damaged or loosely mounted in the retaining straps. It must not show any signs of corrosion on the outside. If it does, it must be replaced.

9.13.2.4 Cleaning the line filter

The reserve line and brake line are both equipped with a line filter. These must be cleaned every 3 to 4 months. Do this as follows:

- Press the cap (a) into the housing and remove the retaining ring (b) from the housing after having compressed it.
- Remove cap with O-ring, compression spring and filter insert.
- Clean filter insert with petrol or thinner (wash out) and dry with compressed air.
- Replace any damaged filter inserts!
- Check O-ring for damage and replace if necessary.
- Reassemble filter in the reverse order and ensure that the O-ring does not cant in the guide slot.

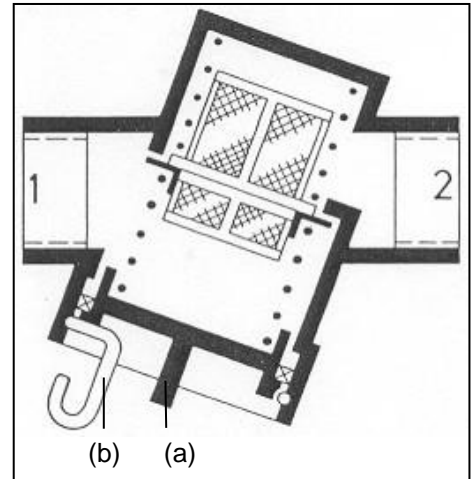

Image: Line filters

9.13.2.5 Leaktightness test

Check screw couplings in the air brake system for leaktightness after the first operating hours and retighten them if necessary

Check the entire brake system for leaks every 3 to 4 months.

- Check all connections and tube, hose and screw connections for leaktightness.
- Repair any leaks.
- Repair any abrasion points on tubes and hoses.
- Replace porous and defective hoses.
- The two-circuit operating brake system is considered leaktight when the pressure loss does not exceed 0.15 bars within 10 minutes.

9.13.2.6 Checking reservoir pressure

The pressure in the reservoir must be checked every 3-4 months. It should amount to 6.0 to 8.1+0.2 bars.

9.13.2.7 Checking brake cylinder pressure

The brake cylinder pressure must be checked every 3-4 months.

Set point:	With released brake	0.0 bar
	With operated brake	according to setting of brake effect regulator

If an ALB regulator is fitted, check the values in accordance with the ALB plate.

9.13.2.8 Checking brake cylinder stroke

The brake cylinder stroke must be checked every 3-4 months. If the stroke is larger than 30 mm during full braking, the brakes must be adjusted.

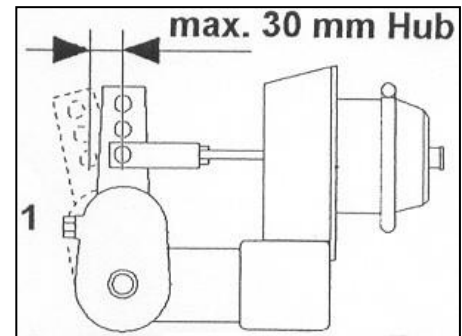

Image: Brake cylinder stroke

9.13.2.9 Adjusting the brake levers

- Unscrew the hexagon nuts from the brake lever clamping screws and remove the screws.
- Bend the slots in the brake levers open a bit and pull the brake levers off the brake shafts.
- Rotate the brake shafts until the linings rub in the drums.
- Slide the brake levers onto the brake shafts in their correct positions up to the stop.
- Fit screws and tighten.
- Check the setting.

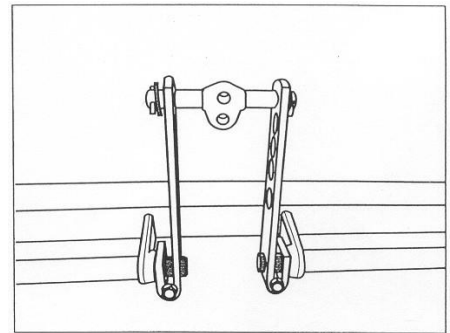

Image: Adjusting the brake levers

9.13.2.10 Adjusting the linkage control element

- The adjustment is made with the adjustment screw of the linkage control element. Set free travel "a" to 10 – 12% of the brake lever length "B", e.g. 150 mm lever length = 15 – 18 mm free travel. (Turn the adjustment screw clockwise until you feel resistance. Then turn the adjustment screw back one half of a rotation.)
- Check wheels for free rotation unbraked.
- Check brake adjustment under full braking.



Axle and brake maintenance must be performed only by authorized workshops.

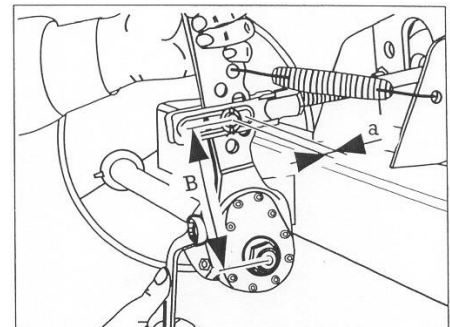

Image: Adjusting the linkage control

9.14 Connection diagrams

Section "Connection diagrams" contains, among others, the following diagrams:

- Connection diagrams – hydraulics
- Connection diagrams – electrical system
- Connection diagrams – brake system

The components and vehicle functions listed in the operating instructions may differ from the vehicle standard equipment and are available as optional features in some cases. Since these operating instructions are general, various equipment options can be listed that are not available for your vehicle. This also applies to illustrations. Images, drawings and 3D illustrations in these operating instructions do not always represent the exact vehicle type. However, the information which refers to the illustrations always corresponds to the vehicle type in this document.

9.14.1 Connection diagrams – hydraulics

9.14.1.1 Version: e-control (part 1)

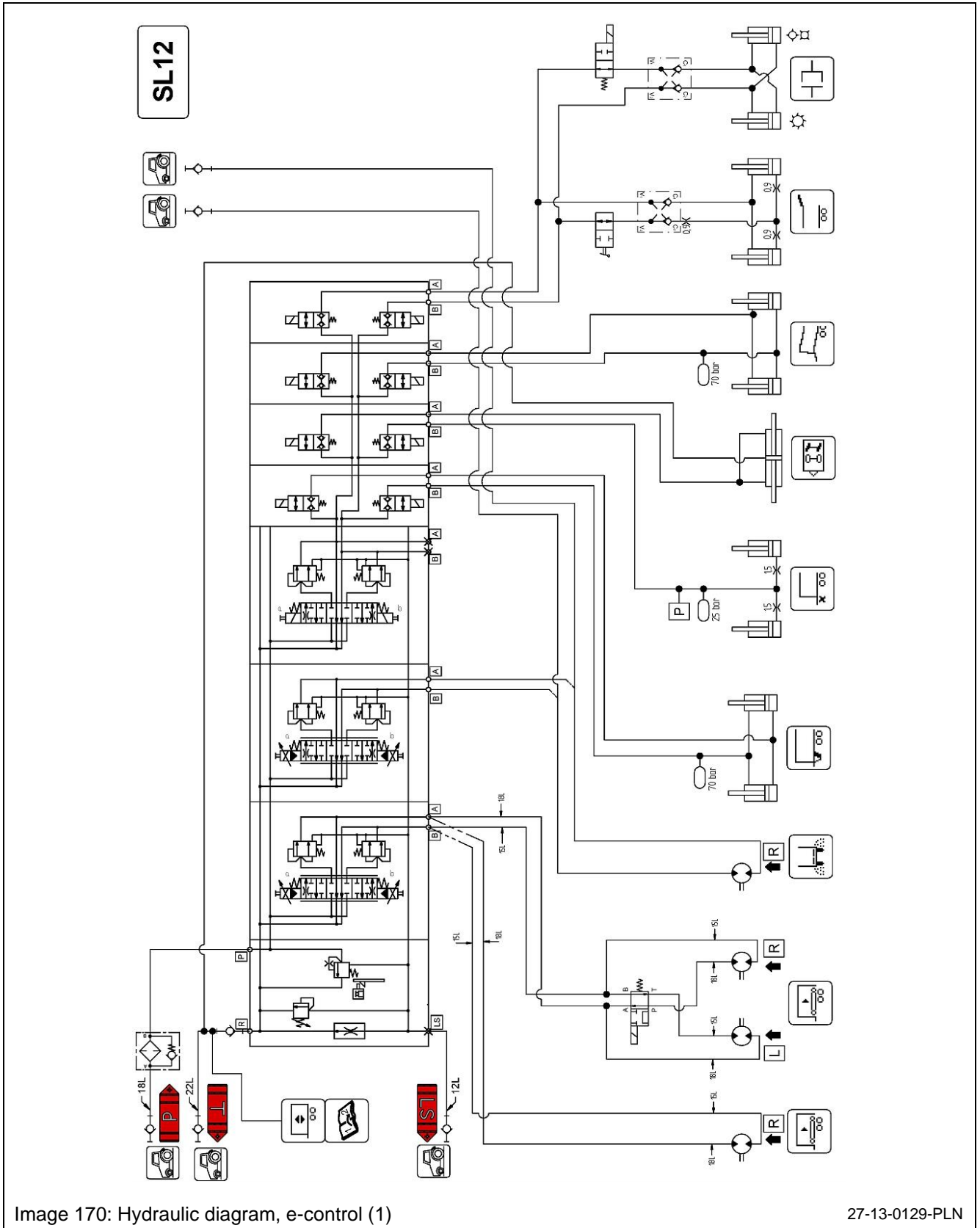

9.14.1.2 Version: e-control (part 2)

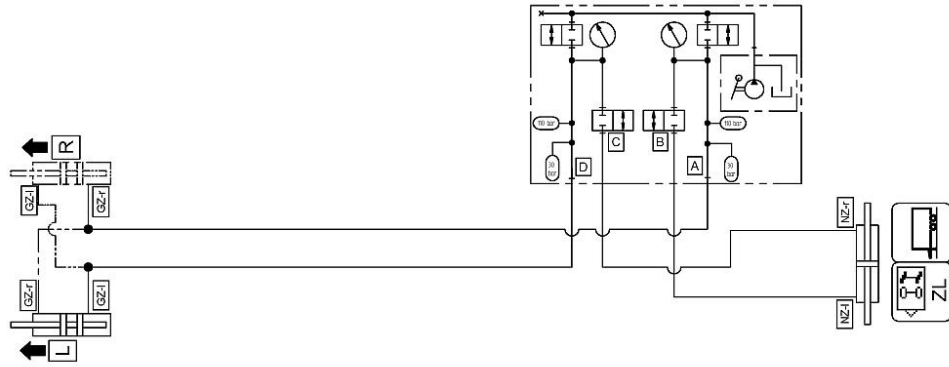

Image 171: Hydraulic diagram, e-control (2)

27-13-0129-PLN

9.14.2 Connection diagrams – brake system

9.14.2.1 Version: Air brake - mechanical axle balance

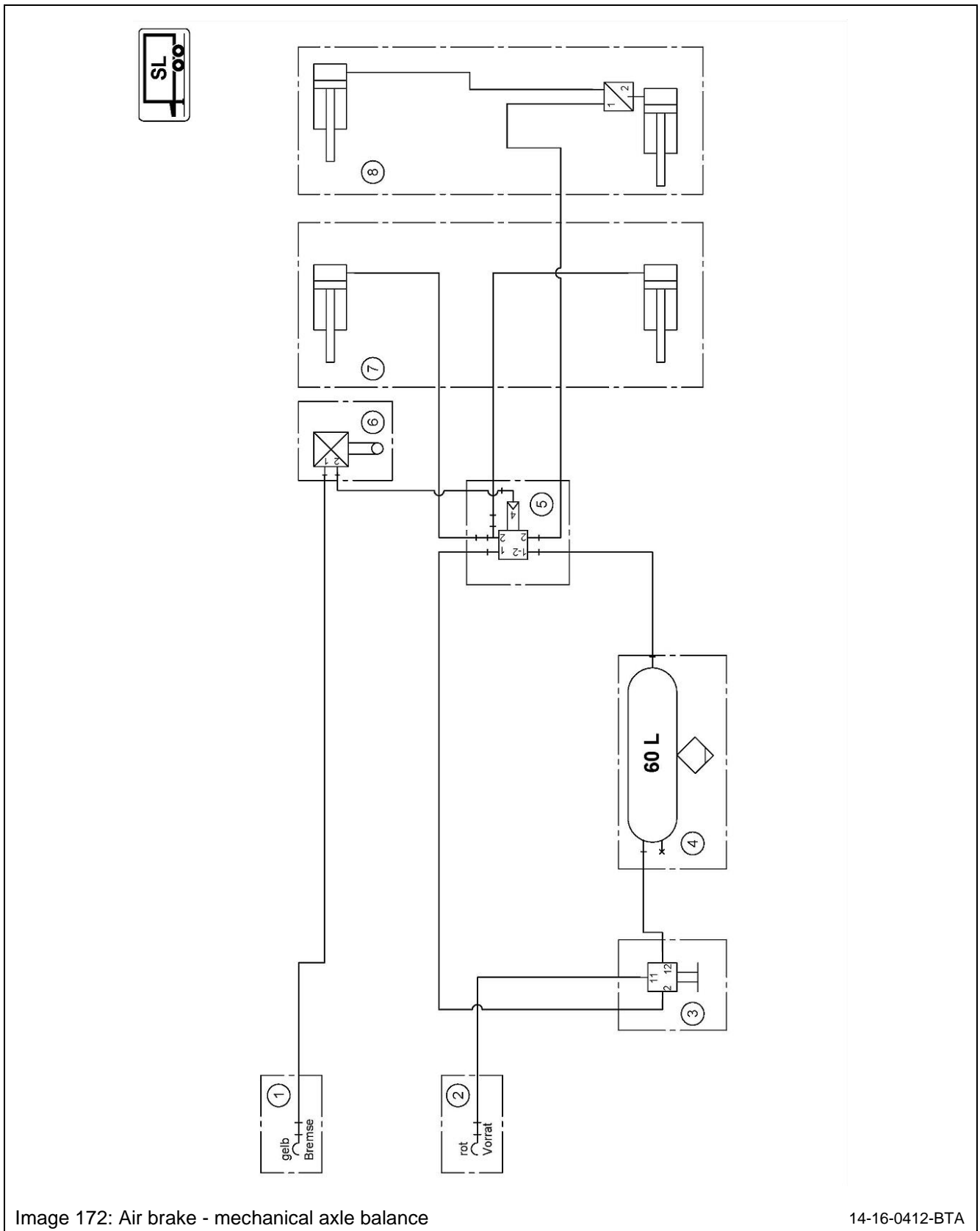

Image 172: Air brake - mechanical axle balance

14-16-0412-BTA

Pos.	Designation	Description
1	Coupling – brake	Yellow
2	Coupling – supply	Red
3	Release valve	
4	Compressed air tank	
5	Trailer control valve	
6	Brake effect regulator - ALB	
7	Membrane cylinder	1st axle
8	Membrane cylinder with adapter valve	2nd axle

9.14.3 Connection diagrams – electrical system

9.14.3.1 BCT 20 terminal

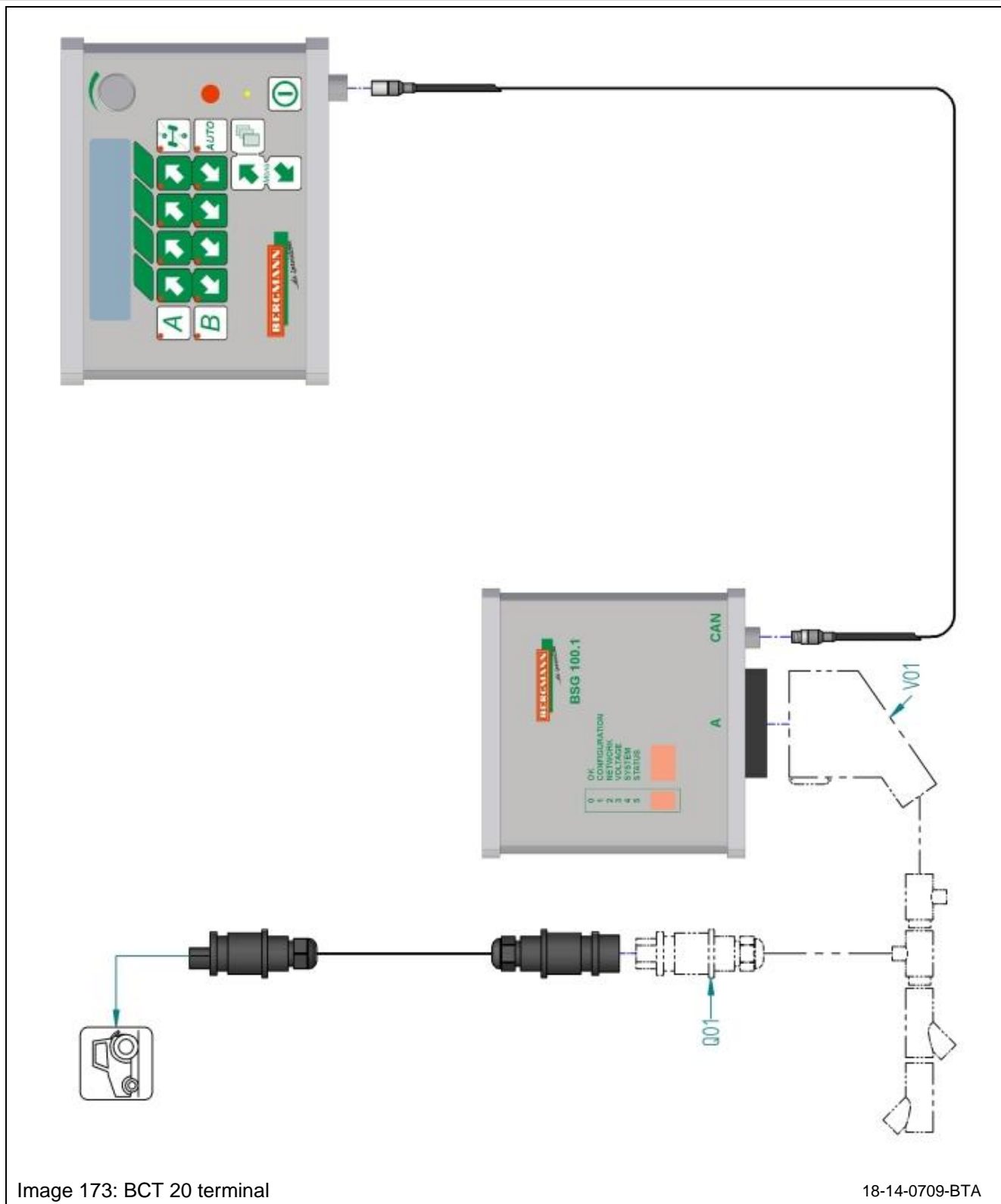

Image 173: BCT 20 terminal

18-14-0709-BTA

9.14.3.2 CCI 50 & CCI 200 terminal (standard 1)

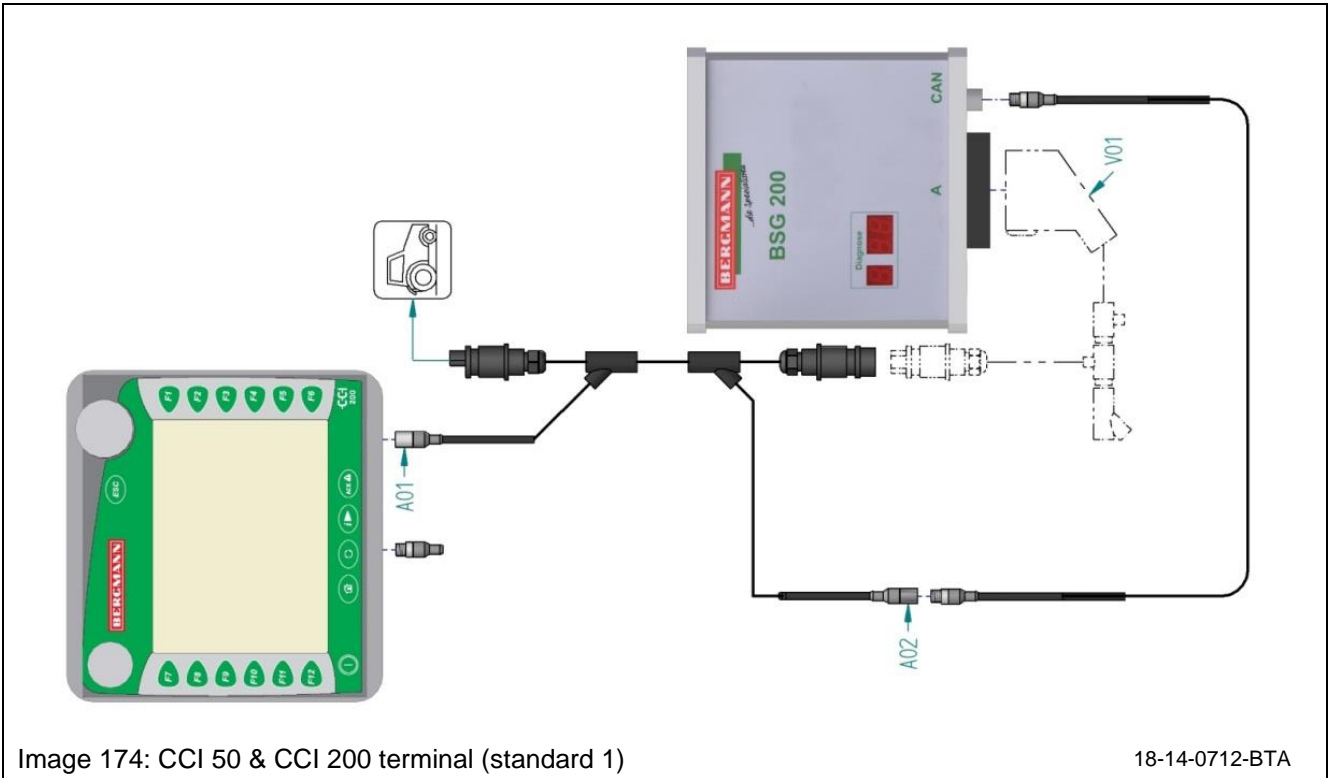

Image 174: CCI 50 & CCI 200 terminal (standard 1)

18-14-0712-BTA

9.14.3.3 CCI 50 & CCI 200 terminal (standard 2)

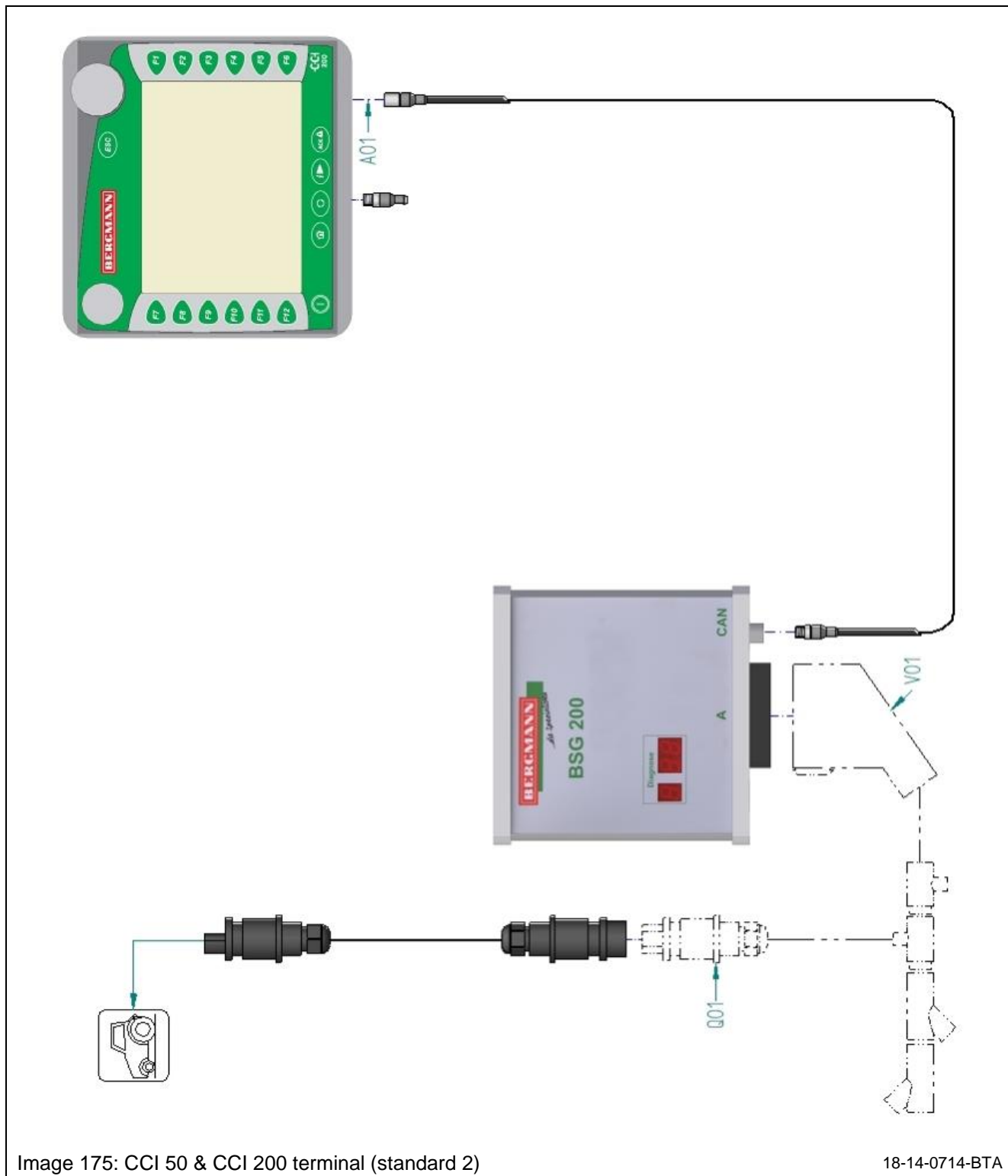

Image 175: CCI 50 & CCI 200 terminal (standard 2)

18-14-0714-BTA

9.14.3.4 CCI 50 & CCI 200 terminal (optional)

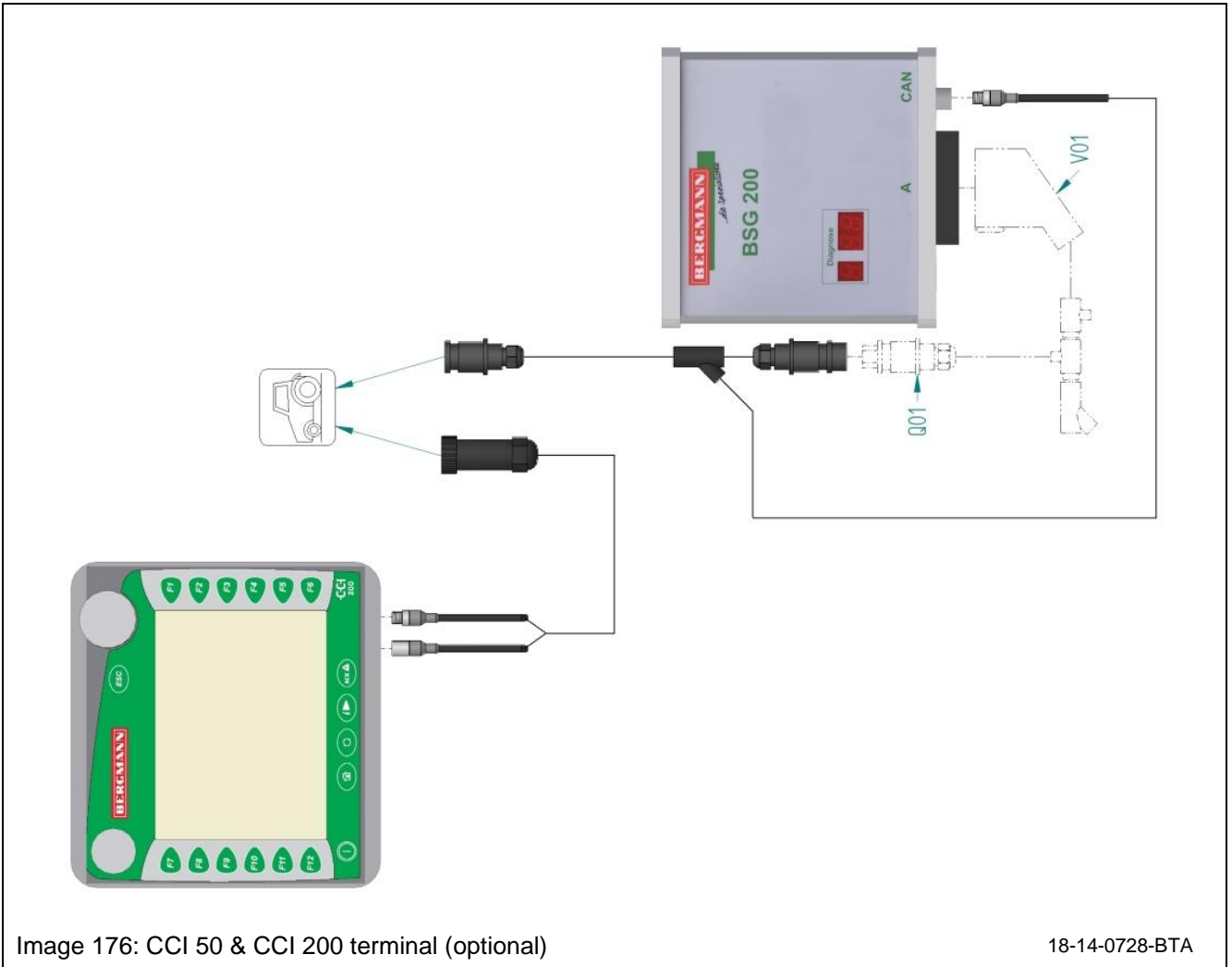

Image 176: CCI 50 & CCI 200 terminal (optional)

18-14-0728-BTA

9.14.3.5 ISOBUS terminal (standard 1)

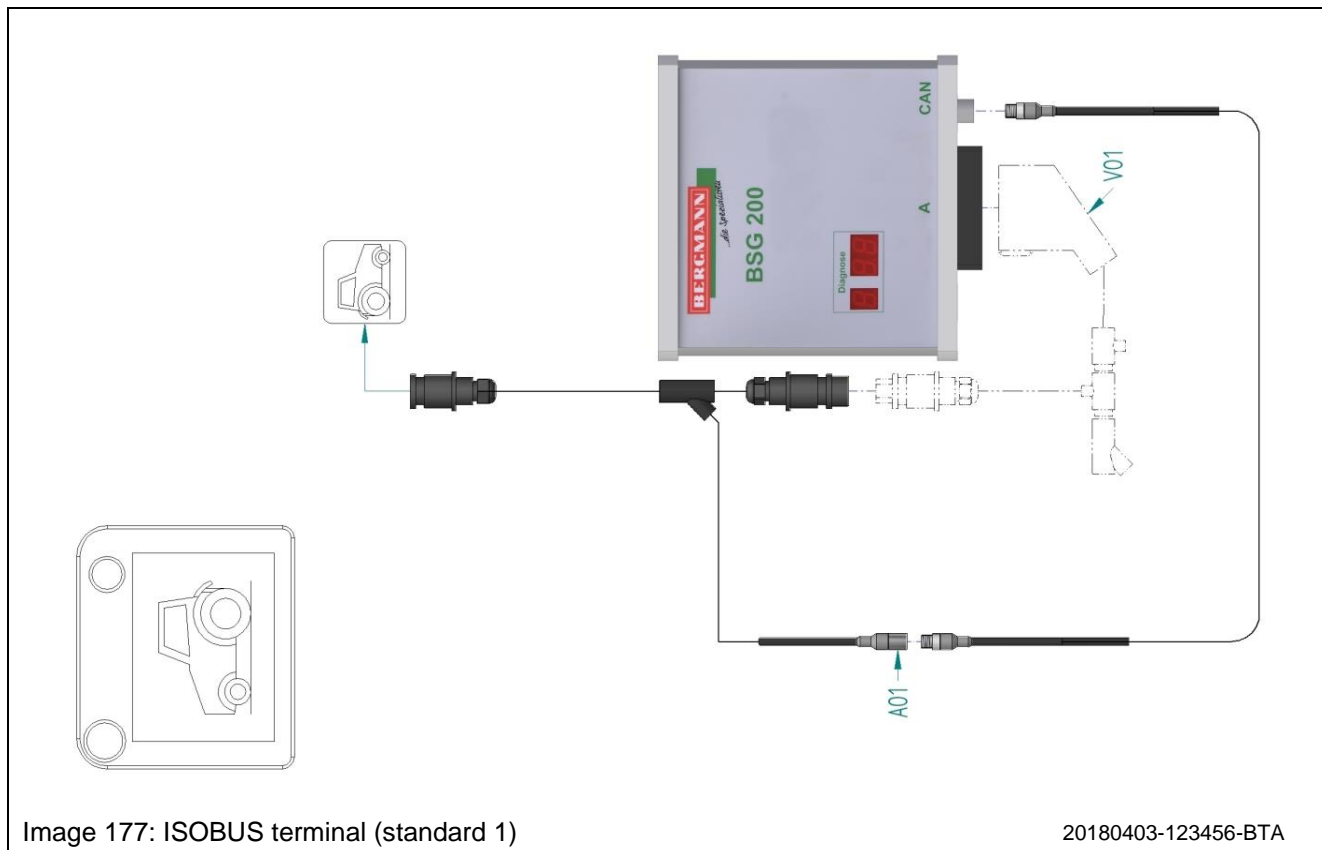

Image 177: ISOBUS terminal (standard 1)

20180403-123456-BTA

9.14.3.6 ISOBUS terminal (standard 2)

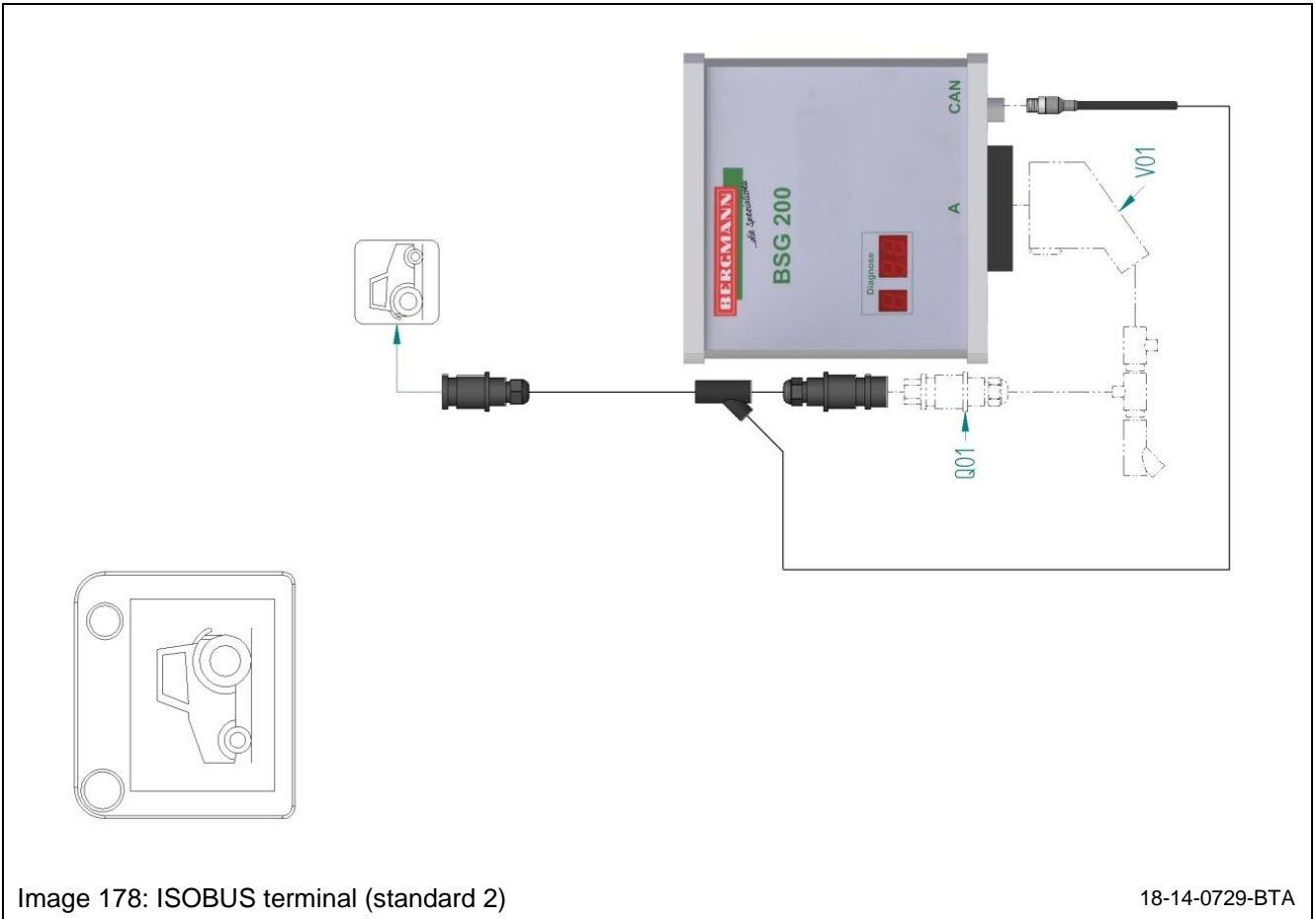

Image 178: ISOBUS terminal (standard 2)

18-14-0729-BTA

9.14.3.7 Terminal Pilotbox cross conveyor belt (silage trailer)

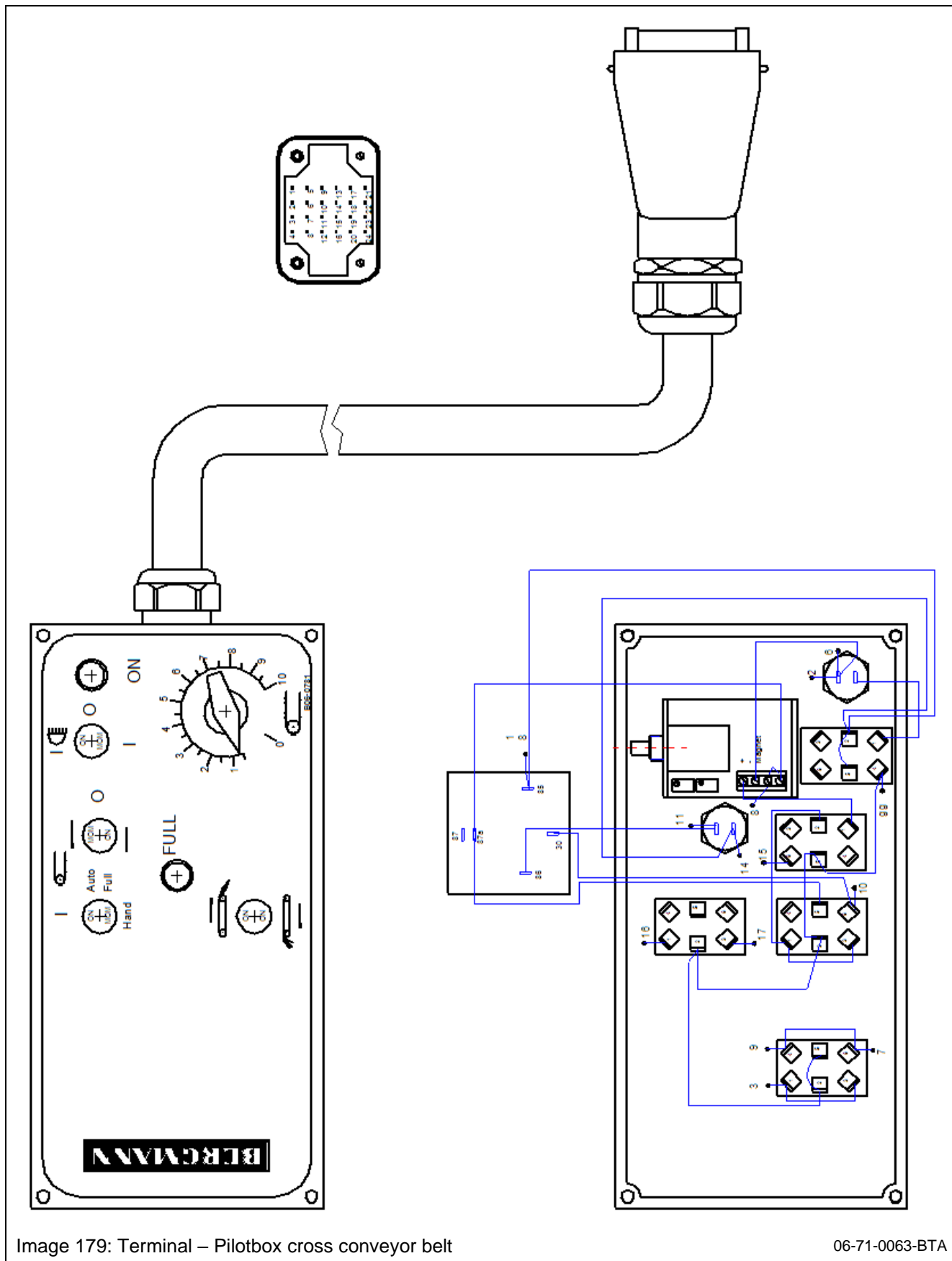

Image 179: Terminal – Pilotbox cross conveyor belt

06-71-0063-BTA

9.14.3.8 Wiring harness BCT / CCI / ISOBUS

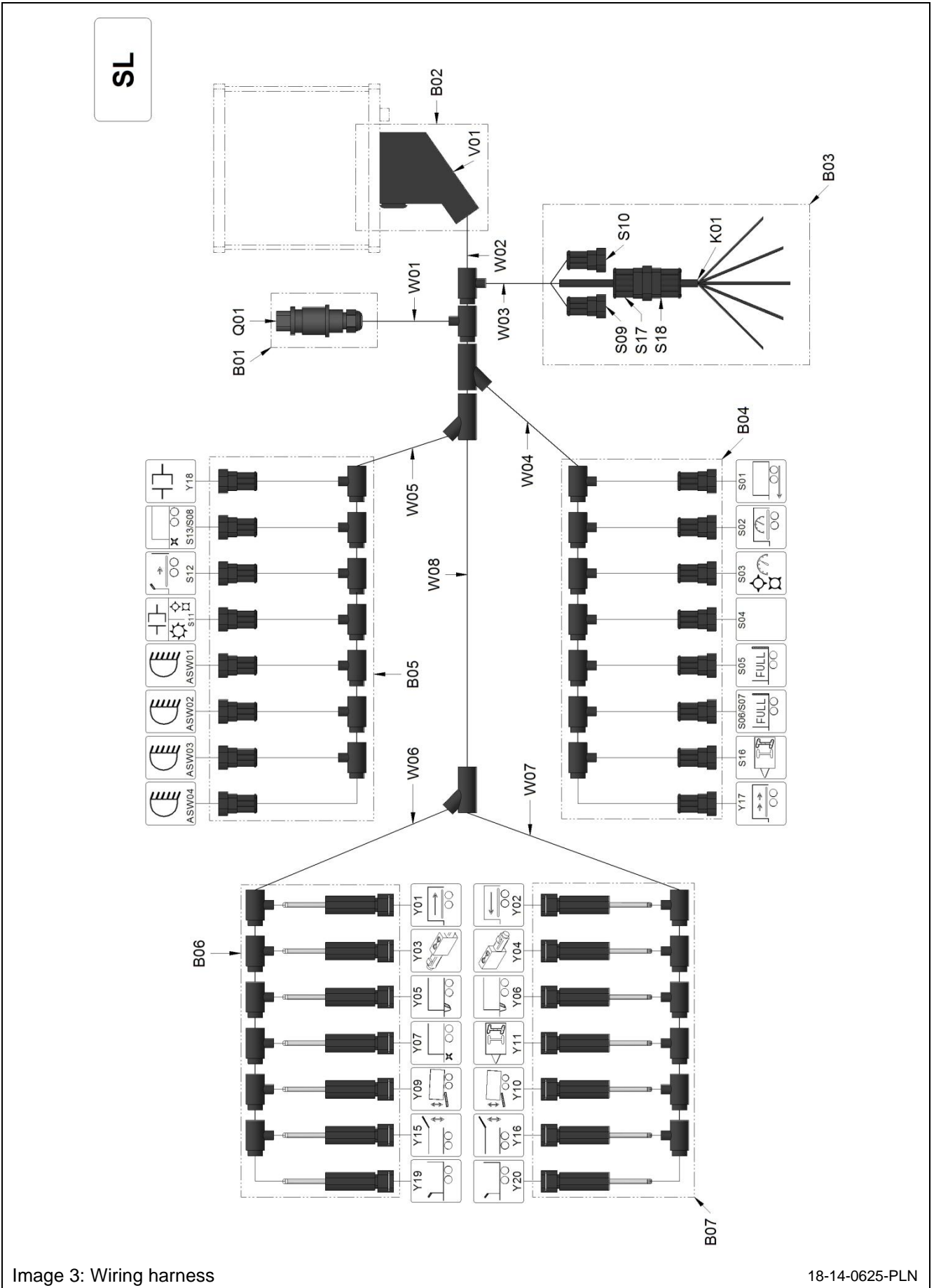

Image 3: Wiring harness

18-14-0625-PLN

9.14.3.8.1 Wiring harness legend

ASW ...	Work spotlight plug
B ...	Block no.
K ...	Cable end no.
S ...	Sensor plug
Q ...	Plug source
V ...	Plug distributor
W ...	Conduit no.
Y ...	Plug valve
O...	Output
I...	Input

ASW...: Work spotlight plug

ASW01	Spotlight	
ASW02	Spotlight	
ASW03	Spotlight	
ASW04	Spotlight	

S ...: Sensor plug

S01	Driving speed	ABS sensor
S02	Scraper floor speed	Ind. closer
S03	(Spreader drum speed)	Hall sensor
S04		
S05	Full signal tailgate left (K Veh.)	Ind. opener
S06	Full signal dosing roller (S Veh.) / tailgate ri. (K Veh.)	Ind. opener
S07	Full signal tailgate	Pressure switch
S08	Pick-up relief	Pressure switch
S09	Cutting unit down	Ind. opener
S10	Cutting unit up	Ind. opener
S11	Switching	Ind. opener
S12	Auto-Filling	Ind. Closer
S13	Pick-up pressure sensor	Analogue current
S16	Pressure switch steering axle	Pressure switch

Y ...: Plug valve

Y01	Scraper floor forward (Prop.)	
Y02	Scraper floor reverse	
Y03	Pilot control valve	
Y04	Pilot control valve	
Y05	Cutting Unit	
Y06	Cutting Unit	
Y07	Pick- Up	
Y08		
Y09	High-lift drawbar	
Y10	High-lift drawbar	
Y11	Steering axle	
Y12		
Y13		
Y14		
Y15	Tailgate	
Y16	Tailgate	
Y17	Scraper floor overdrive	
Y18	Switching/clutch	
Y19	Front wall flap	
Y20	Front wall flap	

10 Faults and remedies

The following sections list various faults that can occur both during operation and when handling the vehicle. The listed causes and instructions for remedying them are intended to assist in rectifying the fault.



When rectifying faults, see also the instructions and notes in the operating instructions, chapters “Functions and settings” and “Care and maintenance”.

Should anything be unclear, please contact BERGMANN customer service to obtain information about rectifying the fault.



BERGMANN contact information can be found in chapter “Contact details & contact persons”.

10.1 Loader wagon (general)



Fault	Cause	Remedy
PTO cardan shaft overload protection responds	Excessive accumulation of feed, foreign bodies or blunt knives, or excessive stack height above the conveying channel	Reduce driving speed, remove foreign bodies, sharpen knives or start feed earlier.
Poor cut quality	Blunt knives or feed packages on the conveying elements too small	Regrind the knives on time or run at lower speed. Where possible, take from the raked mowing (swath) and not from loose mowings
Load is taken up with impurities	Pick-Up set too low	Setting the guide wheels and checking trailer hitch height
Pick-Up guide wheels are not on the ground	Pick-Up set poorly	Setting the guide wheels and checking trailer hitch height
Pick-Up working unevenly	Pick-Up guide wheels are making contact unevenly	Check for even setting of the guide wheels
Dosing rollers entangling	Knives are blunt or incorrectly set (too much uncut material or choke-up in the tailgate space)	Regrind knives or drive forward more quickly when unloading
Dosing roller clutch does not engage	Switched-on PTO	Switch on only at standstill
Dosing rollers continue to run when the rear wall is closed.	Main gearbox clutch does not engage or disengage	Check function of shift mechanism
Compaction unit (rotor) running unevenly	Blunt knives	Sharpen knives
Drive chain noise	Chain not correctly tensioned	Check chain tension; retension if necessary
Scraper floor chain causes loud noise in idle mode	Scraper floor chain tensioned too much	Relieve the chain tension by the same amount on both sides until it hangs through slightly.
Dosing rollers jammed	Load pressed into the rollers too firmly. Filling level indicator not observed	Reverse feed (if possible)

10.2 Central lubrication system

Fault	Cause	Remedy
Stirrer blade in grease reservoir does not rotate when pump is running.	Mechanical damage e.g. motor is defective	Replace pump: Disconnect lubricant reservoir at pressure relief valve outlet. Disconnect electrical connection. Remove the three mounting screws. Remove defective pump. Mount new pump and connect lubricant line and electrical cable. Commission and conduct function test. Check for proper interval and contact times!
	Electrical connection interrupted	Check fuse and replace if necessary. Check electrical connection. Check cables for damage.
Pump does not function when DK button is pressed even though all electrical connections are in order.	Electric control system failed Pump drive / motor defective	Replace pump
Pump does not pump lubricant even though stirrer blade rotates.	Lubricant level in reservoir below minimum	Fill lubricant reservoir to maximum.
	Check valve in pump element does not close (can be detected when the main line is disconnected and the outlet can be held closed with a finger).	Replace pump element Note: Check the correct number of dosing grooves on the pump element
	Suction problems caused by bubbles in grease	Remove pump element and activate pump using DK button until grease comes out of the housing outlet.
	Pump element does not build pressure. Pump element is worn. (can be detected when the main line is disconnected and the outlet can be held closed with a finger).	Replace pump element Note: Check the correct number of dosing grooves on the pump element.
Pressure relief valve on pump opens and lubricant leaks out.	System pressure above 300 bar, e.g. due to manifold blockage or blocked lubrication point	Check system pressure and correct, or modify system so that system pressure at 20 °C is max. 200 bars.
	A valve is damaged and/or soiled and does not close properly	Replace pressure relief valve
Pump does not run.	No power supply to Pilotbox	Repair electrical system on tractor or vehicle.
	Pump defective	Call customer service
Pump turns in wrong direction (must turn anticlockwise)	Electrical socket installed incorrectly	Install electrical socket correctly
	Supply cable installed incorrectly	Install supply cable correctly
Pump runs but grease pressure remains below 10 bars	Grease reservoir was empty	Remove grease line from pump and let pump run until grease escapes without bubbles
	Check valve in pump soiled or defective	Change pump elements
Grease pressure raises to 300 bars.	Lubrication point clogged Manifold clogged	Call customer service
No grease collar at several lubrication points.	Supply line to manifold defective or leaking	Replace lines or retighten screw couplings. If grease pressure then rises to 300 bars, call customer service.

11 Declaration of Conformity

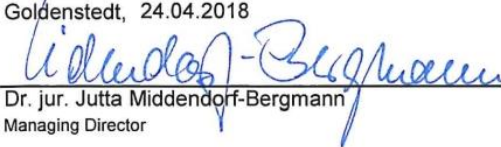
11.1.1 ROYAL 260 S / 280 S / 280 K / 300 K

	<h2>EC-Declaration of Conformity</h2>	Translation en
according to 2006/42/EC, Annex II, No. 1 A		
Manufacturer: Ludwig Bergmann GmbH Maschinenfabrik Hauptstraße 64 - 66 49424 Goldenstedt / Germany		
Person established in the Community / authorised to compile technical data Martin Kallage Hauptstraße 64 - 66 49424 Goldenstedt / Germany		
Description and identification of the machinery		
Designation:	Loader Wagon	
Function:	Loading, cutting, transport and unloading of agricultural harvest	
Type / model:	SL12	
Commercial designation:	ROYAL 260 S / 280 S / 280 K / 300 K	
Vehicle identification no.:	W0902__S_1B73__	
We herewith declare that the machine designated above corresponds to all relevant provisions of the following directive:		
2006/42EC:2006-05-17	Directive 2006/42/EC of the European Parliament and of the Council of 17 May 2006 on machinery, and amending Directive 95/16/EC (recast) (Text with EEA relevance)	
2014/30/EU:2014-02-26	Directive 2014/30/EU of the European Parliament and of the Council of 26 February 2014 on the harmonisation of the laws of the Member States relating to electromagnetic compatibility (recast)	
References of the harmonised standards used, as referred to in Article 7 (2).		
_____ _____ _____ _____ _____ _____ _____ _____ _____ _____		
Goldenstedt, 24.04.2018  Dr. jur. Jutta Middendorf-Bergmann Managing Director	 Dipl.-Ing. (FH) Martin Kallage Head of Development and Design Department Authorized EC documentation representative	

12 Contact Details & Contact Persons

In the following sections you can find contact and contact the company Ludwig Bergmann GmbH, as well as their partners.

If your operating instructions be older, you can find the current data on the company website www.Bergmann-Goldenstedt.de.

12.1 Manufacturer

Ludwig Bergmann GmbH	 +49 (0)4444 - 2008-0
	 +49 (0)4444 - 2008-88
	 -
Hauptstraße 64-66 49424 Goldenstedt	 info@l-bergmann.de
	 www.Bergmann-Goldenstedt.de

12.2 Authorized officer / Sale

Viktor Ripke	 +49 (0)4444 - 2008-12
	 +49 (0)4444 - 2008-88
	 +49 (0)171 - 2123844
Hauptstraße 64-66 49424 Goldenstedt	 ripke@l-bergmann.de
	 www.Bergmann-Goldenstedt.de

12.3 General Manager Export

Christian Ludwig	 +49 (0)4444 - 2008-41
	 +49 (0)4444 - 2008-88
	 +49 (0)175 - 5888841
Hauptstraße 64-66 49424 Goldenstedt	 christian.ludwig@l-bergmann.de
	 www.Bergmann-Goldenstedt.de

12.4 Sales management Export West

Thomas Kastler	 +49 (0)4444 - 2008-11
	 +49 (0)4444 - 2008-88
	 +49 (0)160 - 96950157
Hauptstraße 64-66 49424 Goldenstedt	 thomas.kastler@l-bergmann.de
	 www.Bergmann-Goldenstedt.de

12.5 Sales management Export East

Eugen Wiens	 +49 (0)4444 - 2008-10
	 +49 (0)4444 - 2008-88
	 +49 (0) 151 - 17618648
Hauptstraße 64-66 49424 Goldenstedt	 eugen.wiens@l-bergmann.de
	 www.Bergmann-Goldenstedt.de

12.6 Spare Parts Stock

Spare Parts Stock	 +49 (0)4444 - 2008-16
	 +49 (0)4444 - 2008-25
	 -
Hauptstraße 64-66 49424 Goldenstedt	 ersatzteil@l-bergmann.de
	 www.Bergmann-Goldenstedt.de

12.7 Customer service management

Jörg Kammacher	 +49 (0)4444 - 2008-15
	 +49 (0)4444 - 2008-43
	 -
Hauptstraße 64-66 49424 Goldenstedt	 kundendienst@l-bergmann.de
	 www.Bergmann-Goldenstedt.de

12.8 Emergency service

Emergency service	 +49 (0)175 - 58 88 82 0
--------------------------	---

12.9 Worldwide Sales Partners

Find our worldwide sales partners on our website www.bergmann-goldenstedt.de.